

OPERATING MANUAL

Haier

ROOM AIR CONDITIONER
WALL MOUNTED TYPE

HSU30HEA03/R2(DB)

Please read this operation manual before using the conditioner.
Keep this operation manual for future reference.

NO.0010521199

IT CONFORMITÀ ALLE DIRETTIVE EUROPEE PER I MODELLI:

CE

Tutti i prodotti sono conformi alle seguenti normative europee:

- Direttiva 73/23/EEC Basso Voltaggio
- Direttiva 2006/95/EC Basso Voltaggio
- Direttiva 89/336/EEC Compatibilità elettromagnetica
- Direttiva 2004/108/EC Compatibilità elettromagnetica

ROHS

Il prodotto è conforme alla normativa 2002/95/EEC sulla restrizione d'uso di sostanze inquinanti negli apparecchi elettrici ed elettronici.

WEEE

Informativa al consumatore come previsto dalla normativa europea 2002/96/CE riguardante i rifiuti di apparecchiature elettriche ed elettroniche.

SPECIFICHE DI SMALTIMENTO:



Il climatizzatore è contrassegnato con questo simbolo, ciò significa che i prodotti elettrici ed elettronici non possono essere smaltiti insieme ai rifiuti domestici non differenziati. Non cercare di demolire il sistema da soli: la demolizione dei sistemi di condizionamento, nonché il recupero del refrigerante, dell'olio e di qualsiasi altra parte devono essere eseguiti da un installatore qualificato in conformità alla legislazione locale e nazionale

vigente in materia. I climatizzatori devono essere trattati presso una struttura specializzata nel riutilizzo, riciclaggio e recupero dei materiali. Il corretto smaltimento del prodotto eviterà le possibili conseguenze negative all'ambiente e alla salute dell'uomo. Per maggiori informazioni contattare l'installatore o le autorità locali. Le batterie devono essere tolte dal telecomando e smaltite separatamente conformemente alla legislazione locale e nazionale vigente in materia.

EN EUROPEAN REGULATIONS CONFORMITY FOR THE MODELS:

CE

All the products are in conformity with the following European provision:

- Low Voltage Directive 73/23/EEC
- Low Voltage Directive 2006/95/EC
- Electromagnetic Compatibility 89/336/EEC
- Electromagnetic Compatibility 2004/108/EC

ROHS

The products are fulfilled with the requirements in the directive 2002/95/EEC of the European parliament and of the council on the Restriction of the use of Certain Hazardous Substances in Electrical and Electronic Equipment (EU RoHS Directive).

WEEE

In accordance with the directive 2002/96/CE of the European parliament, herewith we inform the consumer about the disposal requirements of the electrical and electronic products.

DISPOSAL REQUIREMENTS:



Your air conditioning product is marked with this symbol. This means that electrical and electronic products shall not be mixed with unsorted household waste.

Do not try to dismantle the system yourself: the dismantling of the air conditioning system, treatment of the refrigerant, of oil and of other part must be done by a qualified installer in accordance with relevant local and national legislation. Air conditioners must be

treated at a specialized treatment facility for re-use, recycling and recovery. By ensuring this product is disposed of correctly, you will help to prevent potential negative consequences for the environment and human health. Please contact the installer or local authority for more information. Battery must be removed from the remote controller and disposed of separately in accordance with relevant local and national legislation.

FR CONFORMITÉ AUX DIRECTIVES EUROPÉENNES POUR LES MODÈLES:

CE

Tous les produits sont conformes aux directives européennes suivantes:

- Directive 73/23/CEE Basse tension
- Directive 2006/95/CE Basse tension
- Directive 89/336/CEE Compatibilité électromagnétique
- Directive 2004/108/CE Compatibilité électromagnétique

ROHS

L'appareil est conforme à la directive 2002/95/CEE relative à la limitation de l'utilisation de certains substances dangereuses dans les équipements électriques et électroniques.

DEEE (WEEE)

Information au consommateur comme le prévoit la directive européenne 2002/96/CE relative aux déchets d'équipements électriques et électroniques.

SPECIFICATIONS POUR L'ELIMINATION:



Ce pictogramme, apposé sur le climatiseur, signifie que les équipements électriques et électroniques ne peuvent pas être éliminés avec les déchets ménagers non triés. Ne pas essayer de démonter l'équipement soi-même: le démantèlement des systèmes de climatisation, ainsi que la récupération du frigorigène, de l'huile et de toute autre partie doivent être effectués par un installateur qualifié conformément à la législation

locale et nationale en vigueur en la matière. Les climatiseurs doivent être traités dans un centre spécialisé dans la réutilisation, le recyclage et la valorisation des matériaux. L'élimination correcte de ces appareils permet d'éviter les effets nocifs sur l'environnement et la santé humaine. Pour plus de renseignements contacter l'installateur ou les autorités locales. Les piles doivent être retirées de la télécommande et éliminées séparément, conformément à la législation locale et nationale en vigueur en la matière.

ES CONFORMIDAD EUROPEA DE LAS REGULACIONES PARA LOS MODELOS:

CE

Todos los productos están en conformidad con las siguientes Normativas Europeas:

- Bajo Voltaje directiva 73/23/EEC
- Bajo Voltaje directiva 2006/95/EC
- Compatibilidad electromagnética 89/336/EEC
- Compatibilidad electromagnética 2004/108/EC

ROHS

Los productos cumplen los requisitos de la directiva 2002/95/EEC del parlamento Europeo y el consejo regulador Del uso de materiales peligrosos en equipamientos eléctricos Y electrónicos. (EU RoHS Directiva).

WEEE

De acuerdo con la directiva 2002/96/CE del parlamento Europeo, Informamos al consumidor acerca del reciclaje de los productos Electrónicos y eléctricos.

REQUISITOS PARA LA ELIMINACIÓN:



Su acondicionador de aire está marcado con este símbolo. Esto significa que los productos eléctricos y electrónicos no deben mezclarse con el resto de residuos domésticos no clasificados.

No intente desmontar el sistema usted mismo: El desmantelamiento del acondicionador de aire, así como el tratamiento del refrigerante, aceite y otros componentes, debe ser efectuado por un instalador competente de acuerdo con las normas locales y nacionales aplicables. Los acondicionadores de aire deben ser tratados en instalaciones especializadas para su reutilización, reciclaje y recuperación. Al asegurarse de desechar este producto de la forma correcta, está contribuyendo a evitar posibles consecuencias negativas para el entorno y para la salud de las personas. Contacte, por favor, con el instalador o con las autoridades locales para obtener más información. Las pilas del control remoto deben extraerse y eliminarse por separado y de acuerdo con la normativa local y nacional aplicable.

Haier

AIR CONDITIONERS

Haier Industrial Park, No.1 Haier Road, Qingdao, P.R.China

Contains fluorinated greenhouse gases covered by the Kyoto Protocol _____ A

R410A

1= _____ kg _____ B

2= _____ kg _____ C

1+2= _____ kg _____ D

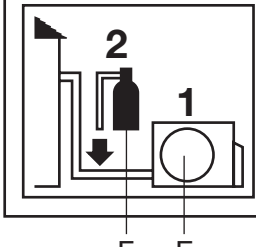

F E

IT INFORMAZIONI IMPORTANTI SUL REFRIGERANTE UTILIZZATO

Questo prodotto contiene gas fluorurati ad effetto serra inclusi nel Protocollo di Kyoto. **Non liberare tali gas nell'atmosfera.**

Tipo di refrigerante: **R410A**

Valore GWP*: **1975**

*GWP = *potenziale di riscaldamento globale*

Compilare con inchiostro indelebile,

- 1 la carica di refrigerante di fabbrica del prodotto
- 2 la quantità di refrigerante aggiuntiva nel campo e
- 1+2 la carica di refrigerante totale

sull'etichetta di carica del refrigerante fornita con il prodotto

L'etichetta compilata deve essere collocata in prossimità della portata di carica del prodotto (ad esempio, nell'interno del coperchio della valvola d'intercettazione).

- A contiene gas fluorurati ad effetto serra inclusi nel protocollo di Kyoto
- B carica di refrigerante di fabbrica del prodotto: vedi targhetta con il nome dell'unità
- C quantità di refrigerante aggiuntiva nel campo
- D carica di refrigerante totale
- E unità esterna
- F cilindro del refrigerante e collettore di carica

EN IMPORTANT INFORMATION REGARDING THE REFRIGERANT USED

This product contains fluorinated greenhouse gases covered by the Kyoto Protocol. **Do not vent into the atmosphere.**

Refrigerant type: **R410A**

GWP* value: **1975**

*GWP = *global warming potential*

Please fill in with indelible ink,

- 1 the factory refrigerant charge of the product
- 2 the additional refrigerant amount charged in the field and
- 1+2 the total refrigerant charge

on the refrigerant charge label supplied with the product.

The filled out label must be adhered in the proximity of the product charging port (e.g. onto the inside of the stop valve cover).

- A contains fluorinated greenhouse gases covered by the Kyoto Protocol
- B factory refrigerant charge of the product: see unit name plate
- C additional refrigerant amount charged in the field
- D total refrigerant charge
- E outdoor unit
- F refrigerant cylinder and manifold for charging

FR INFORMATION IMPORTANTE RELATIVE AU RÉFRIGÉRANT UTILISÉ

Ce produit contient des gaz à effet de serre fluorés encadrés par le protocole de Kyoto. **Ne pas laisser les gaz s'échapper dans l'atmosphère.**

Type de réfrigérant: **R410A**

Valeur GWP*: **1975**

*GWP = *potentiel de réchauffement global*

Prière de compléter à l'encre indélébile,

- 1 la charge de réfrigérant d'usine du produit
- 2 la quantité de réfrigérant supplémentaire chargée sur place et
- 1+2 la charge de réfrigérant totale

sur l'étiquette de charge de réfrigérant fournie avec le produit.

L'étiquette complétée doit être apposée à proximité de l'orifice de recharge du produit (par ex. à l'intérieur du couvercle de la vanne d'arrêt).

- A contient des gaz à effet de serre fluorés encadrés par le protocole de Kyoto
- B charge de réfrigérant d'usine du produit: voir plaquette signalétique de l'unité
- C quantité de réfrigérant supplémentaire chargée sur place
- D charge de réfrigérant totale
- E unité extérieure
- F cylindre de réfrigérant et collecteur de recharge

Haier

AIR CONDITIONERS

Haier Industrial Park, No.1 Haier Road, Qingdao, P.R.China

Contains fluorinated greenhouse gases covered by the Kyoto Protocol — A

R410A

1= kg — B

2= kg — C

1+2= kg — D

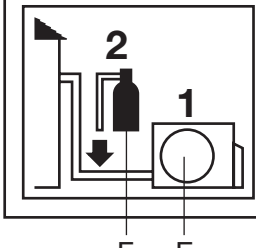

F E

ES INFORMACIÓN IMPORTANTE EN RELACIÓN AL REFRIGERANTE UTILIZADO

Este producto contiene los gases fluorados de efecto invernadero regulados por el Protocolo de Kioto. **No vierta gases a la atmósfera.**

Tipo de refrigerante: **R410A**

Valor GWP*: **1975**

*GWP = *Potencial de calentamiento global*

Rellene con tinta indeleble,

- 1 la carga de refrigerante de fábrica del producto
- 2 la cantidad adicional de refrigerante cargado en campo y
- 1+2 la carga total de refrigerante

En la etiqueta de carga de refrigerante suministrada con el producto.

La etiqueta rellena debe pegarse cerca de la conexión de carga del producto (p.ej. en el interior de la cubierta de la válvula de tope).

- A Contiene los gases fluorados de efecto invernadero regulados por el Protocolo de Kioto
- B Carga de refrigerante de fábrica del producto: véase placa de especificaciones técnicas de la unidad
- C Cantidad adicional de refrigerante cargado en campo
- D Carga total de refrigerante
- E Unidad exterior
- F Cilindro del refrigerante y dosificador de carga

Cautions

Disposal of the old air conditioner

Before disposing an old air conditioner that goes out of use, please make sure it's inoperative and safe. Unplug the air conditioner in order to avoid the risk of child entrapment.

It must be noticed that air conditioner system contains refrigerants, which require specialized waste disposal. The valuable materials contained in an air conditioner can be recycled. Contact your local waste disposal center for proper disposal of an old air conditioner and contact your local authority or your dealer if you have any question. Please ensure that the pipework of your air conditioner does not get damaged prior to being picked up by the relevant waste disposal center, and contribute to environmental awareness by insisting on an appropriate, anti-pollution method of disposal.

Disposal of the packaging of your new air conditioner

All the packaging materials employed in the package of your new air conditioner may be disposed without any danger to the environment.

The cardboard box may be broken or cut into smaller pieces and given to a waste paper disposal service. The wrapping bag made of polyethylene and the polyethylene foam pads

All these valuable materials may be taken to a waste collecting center and used again after adequate recycling.

Consult your local authorities for the name and address of the waste materials collecting centers and waste paper disposal services nearest to your house.

Safety Instructions and Warnings

Before starting the air conditioner, read the information given in the User's Guide carefully. The User's Guide contains very important observations relating to the assembly, operation and maintenance of the air conditioner.

The manufacturer does not accept responsibility for any damages that may arise due to non-observation of the following instruction.

- Damaged air conditioners are not to be put into operation. In case of doubt, consult your supplier.
- Use of the air conditioner is to be carried out in strict compliance with the relative instructions set forth in the User's Guide.
- Installation shall be done by professional people, don't install unit by yourself.
- For the purpose of the safety, the air conditioner must be properly grounded in accordance with specifications.
- Always remember to unplug the air conditioner before opening inlet grill. Never unplug your air conditioner by pulling on the power cord. Always grip plug firmly and pull straight out from the outlet.
- All electrical repairs must be carried out by qualified electricians. Inadequate repairs may result in a major source of danger for the user of the air conditioner.
- Do not damage any parts of the air conditioner that carry refrigerant by piercing or perforating the air conditioner's tubes with sharp or pointed items, crushing or twisting any tubes, or scraping the coatings off the surfaces. If the refrigerant spurts out and gets into eyes, it may result in serious eye injuries.

Cautions

- Do not obstruct or cover the ventilation grille of the air conditioner. Do not put fingers or any other things into the inlet/outlet and swing louver.
- Do not allow children to play with the air conditioner. In no case should children be allowed to sit on the outdoor unit.

Specifications

- The refrigerating circuit is leak-proof.

The machine is adaptive in following situation

1. Applicable ambient temperature range:

Cooling	Indoor	Maximum:D.B/W.B 32°C/23°C Minimum:D.B/W.B 18°C/14°C
	Outdoor	Maximum:D.B/W.B 43°C/26°C Maximum:D.B 18°C
Heating	Indoor	Maximum:D.B 27°C Maximum:D.B 15°C
	Outdoor	Maximum:D.B/W.B 24°C/18°C Minimum:D.B/W.B -7°C/-8°C
	Outdoor (INVERTER)	Maximum:D.B/W.B 24°C/18°C Minimum:D.B/W.B -15°C

- If the power supply cord is damaged, it must be replaced by the manufacturer or its service agent or a similar qualified person.
- If the fuse of indoor unit on PC board is broken, please change it with the type of T. 3.15A/ 250V. If the fuse of outdoor unit is broken, change it with the type of T.25A/250V
- The wiring method should be in line with the local wiring standard.
- After installation, the power plug should be easily reached.
- The waste battery should be disposed properly.
- The appliance is not intended for use by young children or infirm persons without supervision.
- Young children should be supervised to ensure that they do not play with the appliance.
- Please employ the proper power plug, which fit into the power supply cord.
- A breaker should be incorporated into fixed wiring. The breaker should be all-pole switch and the distance between its two contacts should be not less than 3mm.
- The power plug and connecting cable must have acquired the local attestation.
- In order to protect the units, please turn off the A/C first, and at least 30 seconds later, cutting off the power.

Cautions

Safety Instruction

- Please read the following Safety Instructions carefully prior to use.
- The instructions are classified into two levels, WARNING and CAUTION according to the seriousness of possible risks and damages as follows. Compliance to the instructions are strictly required for safety use.

Installation

⚠ WARNING

Please call Sales/Service Shop for the Installation.
Do not attempt to install the air conditioner by yourself because improper works may cause electric shock, fire, water leakage.

Installation in a inadequate place may cause accidents. Do not install in the following place.

⚠ CAUTION

Connect the earth cable.

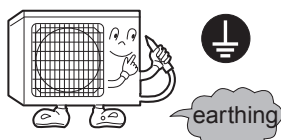

Do not install in the place where there is any possibility of inflammable gas leakage around the unit.



PROHIBITION

Do not get the unit exposed to vapor or oil steam.



PROHIBITION





Check proper installation of the drainage securely

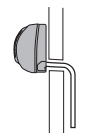

STRICT ENFORCEMENT

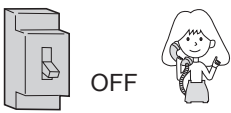
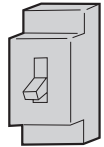

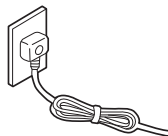
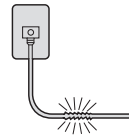
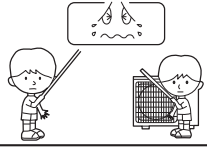
Cautions

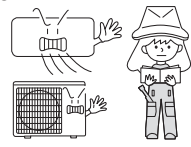
⚠ WARNING		
<p>When abnormality such as burnt-smell found, immediately stop the operation button and contact sales shop.</p>  <p style="text-align: center;">! STRICT ENFORCEMENT</p>	<p>Use an exclusive power source with a circuit breaker</p> 	
<p>Connect power supply cord to the outlet completely</p>  <p style="text-align: center;">! STRICT ENFORCEMENT</p>	<p>Use the proper voltage</p>  <p style="text-align: center;">! STRICT ENFORCEMENT</p>	<p>Do not use power supply cord extended or connected in halfway</p> <p style="text-align: center;">⊘ PROHIBITION</p>
<p>Do not use power supply cord in a bundle.</p>  <p style="text-align: center;">⊘ PROHIBITION</p>	<p>Take care not to damage the power supply cord.</p>  <p style="text-align: center;">⊘ PROHIBITION</p>	<p>Do not insert objects into the air inlet or outlet.</p>  <p style="text-align: center;">⊘ PROHIBITION</p>
<p>Do not start or stop the operation by disconnecting the power supply cord and so on.</p>  <p style="text-align: center;">⊘ PROHIBITION</p>	<p>Do not channel the air flow directly at people, especially at infants or the aged.</p>  <p style="text-align: center;">⊘ PROHIBITION</p>	<p>Do not try to repair or reconstruct by yourself.</p> 

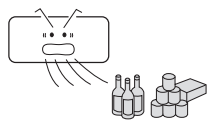
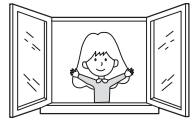
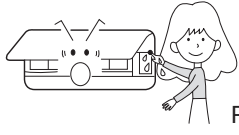
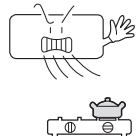
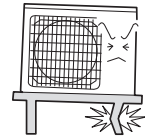
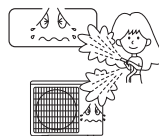
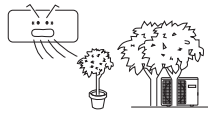
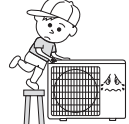
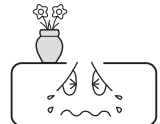
⚠ CAUTION		
<p>Do not use for the purpose of storage of food, art work, precise equipment, breeding, or cultivation.</p>  <p style="text-align: center;">⊘ PROHIBITION</p>	<p>Take fresh air occasionally especially when gas appliance is running at the same time.</p>  <p style="text-align: center;">! STRICT ENFORCEMENT</p>	<p>Do not operate the switch with wet hand.</p>  <p style="text-align: center;">⊘ PROHIBITION</p>
<p>Do not install the unit near a fireplace or other heating apparatus.</p>  <p style="text-align: center;">⊘ PROHIBITION</p>	<p>Check good condition of the installation stand</p>  <p style="text-align: center;">⊘ PROHIBITION</p>	<p>Do not pour water onto the unit for cleaning</p>  <p style="text-align: center;">⊘ PROHIBITION</p>
<p>Do not place animals or plants in the direct path of the air flow</p>  <p style="text-align: center;">⊘ PROHIBITION</p>	<p>Do not place any objects on or climb on the unit.</p>  <p style="text-align: center;">⊘ PROHIBITION</p>	<p>Do not place flower vase or water containers on the top of the unit.</p>  <p style="text-align: center;">⊘ PROHIBITION</p>

Parts and Functions

Indoor unit

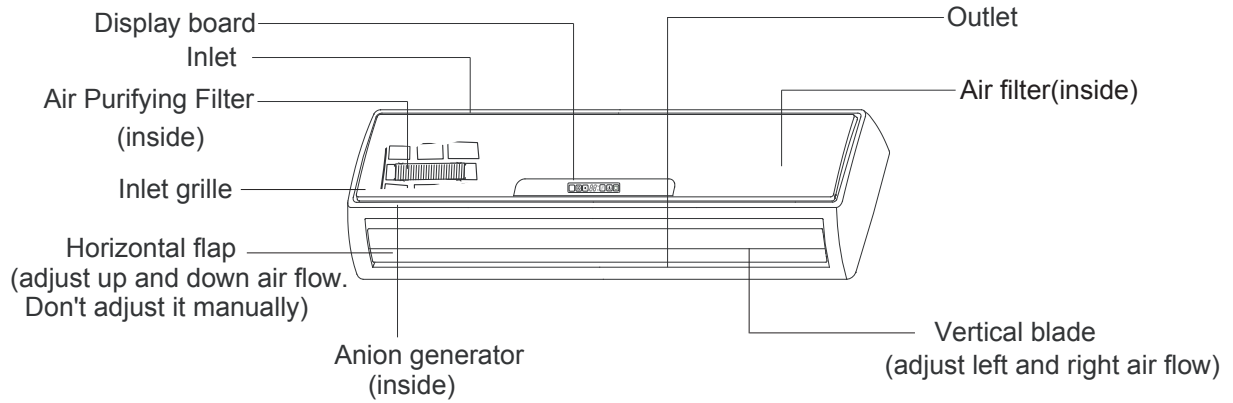

Actual inlet grille may vary from the one shown in the manual according to the product purchased

Outdoor unit

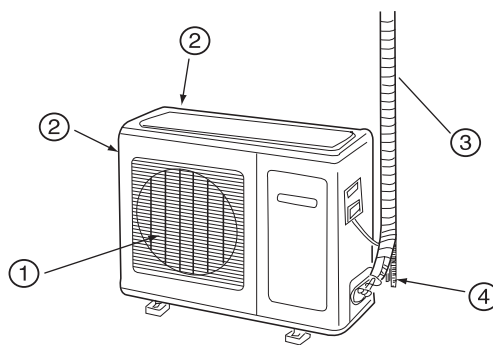

① OUTLET

② INLET

③ CONNECTING PIPING AND ELECTRICAL WIRING

④ DRAIN HOSE

Parts and Functions

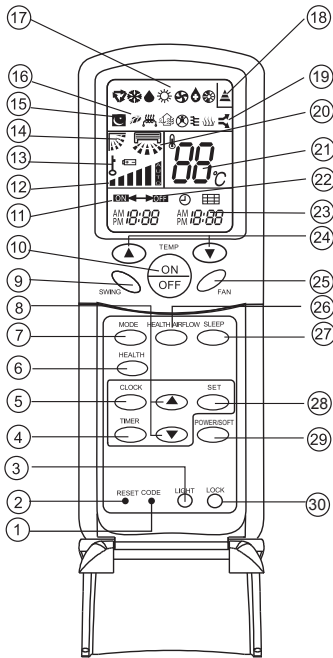

1. CODE

Used to select CODE A or B with a press, A or B will be displayed on LCD. Please select A without special explanation.

2. RESET

When the remote controller appears abnormal, use a sharp pointed article to press this button to reset the remote controller normal.

3. LIGHT button

Control the lightening and extinguishing of the indoor LED display board.

4. TIMER button

Used to select TIMER ON, TIMER OFF, TIMER ON-OFF.

5. CLOCK button

Used to set correct time.

6. HEALTH button

Used to set healthy operation.

7. MODE button



8. HOUR button

Used to set clock and timer setting.

9. SWING button

Used to select up or down air sending direction.

10. ON/OFF button

Used for unit start and stop.

11. TIMER ON display

12. FAN SPEED display



13. LOCK display

14. SWING UP/DOWN display

15. SLEEP display

16. HEALTH display

17. Operation mode display

Operation mode	AUTO	COOL	DRY	FAN	HEAT
Remote controller					

18. Singal sending display

19. POWER/SOFT display

20. Left/right air flow display

21. TEMP display

Remote controller: to display the TEMP. setting.

22. TIMER OFF display

23. CLOCK display

24. TEMP button

Used to select your desired temperature.

25. FAN button

Used to select fan speed: LOW, MED, HI, AUTO.

26. HEALTH AIRFLOW button

Used to set the health airflow mode.

27. SLEEP button

Used to select sleep mode.

28. SET button

Used to confirm timer and clock settings.

29. POWER/SOFT button

Use to set power/soft function.

30. LOCK

Used to lock buttons and LCD display. If pressed, the other buttons will be disabled and the lock condition display appears. Press it once again, lock will be cancelled and lock condition display disappears.

NOTE: The following functions and related displays are not available: (20) (26)

Parts and Functions

■ Clock Set

When unit is started for the first time and after replacing batteries in remote controller, clock should be adjusted as follows:

1. Press CLOCK button, "AM" or "PM" flashes.
2. Press Δ or ∇ to set correct time. Each press will increase or decrease 1 min. If the button is kept depressed, time will change quickly.
3. After time setting is confirmed, press SET, "AM" or "PM" stop flashing, while clock starts working.

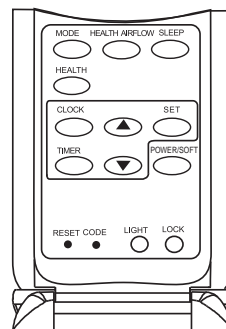

■ Remote controller's operation

- When in use, put the signal transmission head directly to the receiver hole on the indoor unit.
- The distance between the signal transmission head and the receiver hole should be within 7m without any obstacle as well.
- Don't throw or knock the remoter controller.
- When electronic-started type fluorescent lamp or change-over type fluorescent lamp or wireless telephone is installed in the room, the receiver is apt to be disturbed in receiving the signals, so the distance to the indoor unit should be shorter.

■ Loading of the battery

Load the batteries as illustrated right
2 R-03 (7#) batteries

Remove the battery cover:

Slightly press "≡" area and push down the cover as illustrated.

Load the battery:

Be sure that the loading is in line with the "+" / "-".
request as illustrated on the bottom of the case.

Put on the cover again.

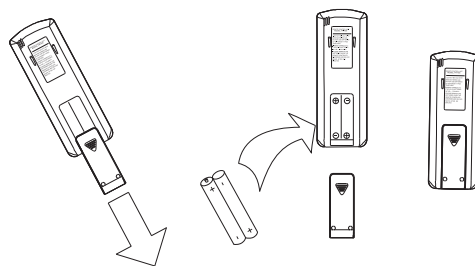

Confirmation indicator:

After pressing power ON/OFF, if no display, reload the batteries.

Note:

- Full display or unclear display during operation indicates the batteries have been used up. Please change batteries.
- Used two new same-typed batteries when loading.
- If the remote controller can't run normally during operation, please remove the batteries and reload several minutes later.

Hint:

Remove the batteries in case unit won't be in usage for a long period. If there are any display after taking-out, just need to press reset key.

Operation

HEALTH operation



24°C

Remote controller

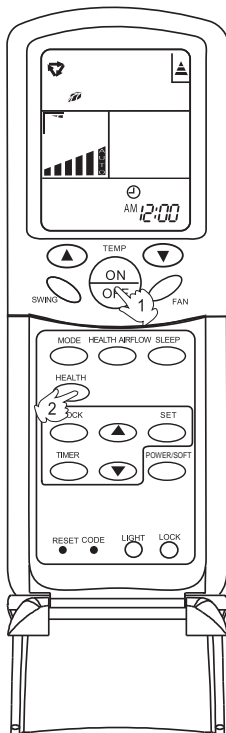

1. Unit start

Press ON/OFF on the remote controller, unit starts.

Health function includes health anion function.

2. Health anion function

Press HEALTH button. For each press, is displayed.

Air conditioner starts health anion function operation.

For twice press, disappears, the operation stops.

When indoor fan motor is running, it has healthy process function. (It's available under any mode)

When the fan in the indoor unit does not work, the health lamp lights up, but the anion generator does not release anion.

BRIEF INTRODUCTION TO HEALTH ANION FUNCTION

The anion generator in the air conditioner can generate a lot of anion effectively balance the quantity of position and anion in the air and also to kill bacteria and speed up the dust sediment in the room and finally clean the air in the room.

Operation

Auto Operation



24°C

Remote controller

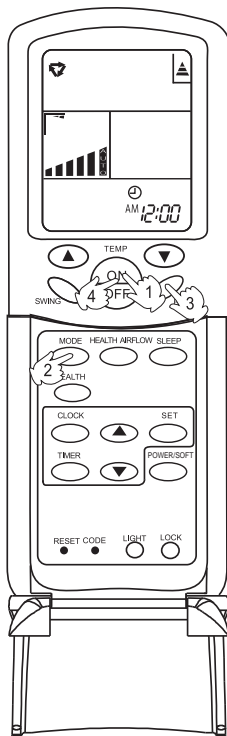

1. Unit start

Press ON/OFF on the remote controller, unit starts.

2. Select operation mode

Press MODE button. For each press, operation mode changes as follows:

Remote controller:



Then

Select Auto operation

3. Fan speed selection

Press FAN button. For each press, fan speed changes as follows:

Remote controller:



Air conditioner is running under displayed fan speed. When FAN is set to AUTO, the air conditioner automatically adjusts the fan speed according to room temperature.

4. Unit stop

Press ON/OFF button, the unit stops.

About Auto Operation

Under the mode of auto operation, air conditioner will automatically select Cool or Heat operation according to room temperature.

Operation

Cool Operation



24°C

Remote controller

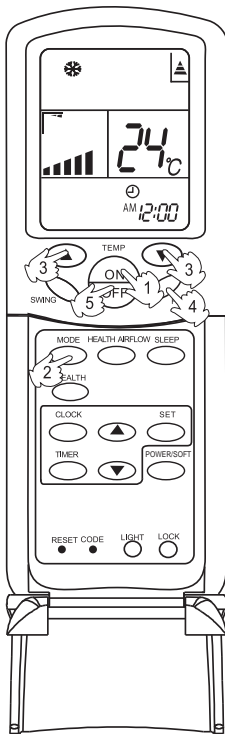

1. Unit start

Press ON/OFF on the remote controller, unit starts.

2. Select operation mode

Press MODE button. For each press, operation mode changes as follows:

Remote controller:



Then Select COOL operation

3. Select temp. setting

Press TEMP. button

△ Every time the button is pressed, temp. setting increase 1°C, if kept depressed, it will increase rapidly

▽ Every time the button is pressed, temp. setting decrease 1°C, if kept depressed, it will decrease rapidly

Select a desired temperature.

4. Fan speed selection

Press FAN button. For each press, fan speed changes as follows:

Remote controller:



Air conditioner is running under displayed fan speed. When FAN is set to AUTO, the air conditioner automatically adjusts the fan speed according to room temperature.

5. Unit stop

Press ON/OFF button, the unit stops.

Operation

Dry Operation

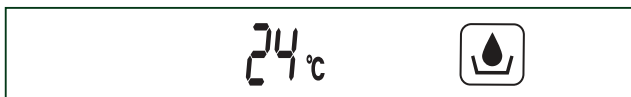

Remote controller

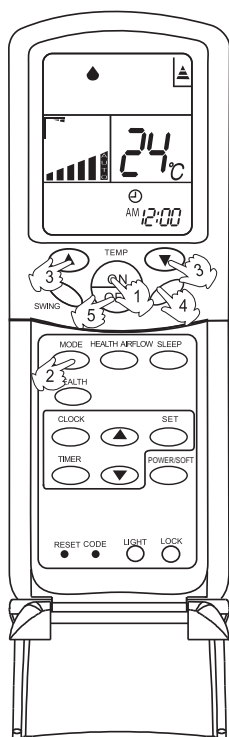

1. Unit start

Press ON/OFF on the remote controller, unit starts.

2. Select operation mode

Press MODE button. For each press, operation mode changes as follows:

Remote controller:



Then Select DRY operation

3. Select temp. setting

Press TEMP. button

△ Every time the button is pressed, temp. setting increase 1°C, if kept depressed, it will increase rapidly

▽ Every time the button is pressed, temp. setting decrease 1°C, if kept depressed, it will decrease rapidly

Select a desired temperature.

4. Fan speed selection

Press FAN button. For each press, fan speed changes as follows:

Remote controller:



Air conditioner is running under displayed fan speed. In DRY mode, when room temperature becomes lower than temp. setting + 2°C, unit will run intermittently at LOW speed regardless of FAN setting.

5. Unit stop

Press ON/OFF button, the unit stops.

Operation

Fan Operation

24°C

Remote controller

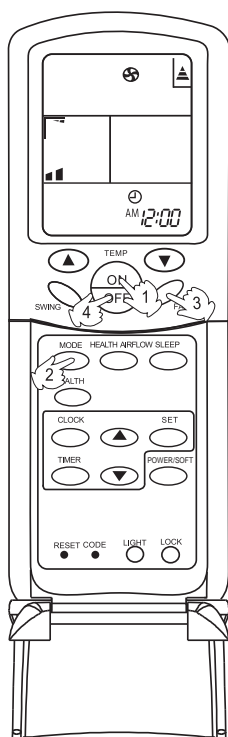

1. Unit start

Press ON/OFF on the remote controller, unit starts.

2. Select operation mode

Press MODE button. For each press, operation mode changes as follows:

Remote controller:



Then **Select FAN operation**

3. Fan speed selection

Press FAN button. For each press, fan speed changes as follows:

Remote controller:



4. Unit stop

Press ON/OFF button, the unit stops.

About FAN operation

In FAN operation mode, the unit will not operate in COOL or HEAT mode but only in FAN mode, AUTO is not available in FAN mode. And temp. setting is disabled. In FAN mode, SLEEP operation is not available.

Operation

Heat Operation



Remote controller

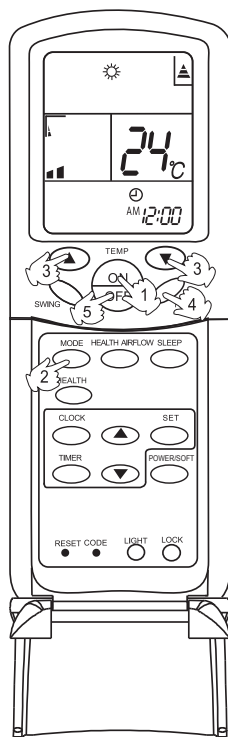

1. Unit start

Press ON/OFF on the remote controller, unit starts.

2. Select operation mode

Press MODE button. For each press, operation mode changes as follows:

Remote controller:



Then Select HEAT operation

3. Select temp. setting

Press TEMP. button

△ Every time the button is pressed, temp. setting increase 1°C, if kept depressed, it will increase rapidly

▽ Every time the button is pressed, temp. setting decrease 1°C, if kept depressed, it will decrease rapidly

Select a desired temperature.

4. Fan speed selection

Press FAN button. For each press, fan speed changes as follows:

Remote controller:



Air conditioner is running under displayed fan speed IN HEAT mode, warm air will blow out after a short period of the time due to cold-draft prevention function.

When FAN is set to AUTO, the air conditioner automatically adjusts the fan speed according to room temperature.

5. Unit stop

Press ON/OFF button, the unit stops.

Operation

Air Flow Direction Adjustment

1. Status display of air sending

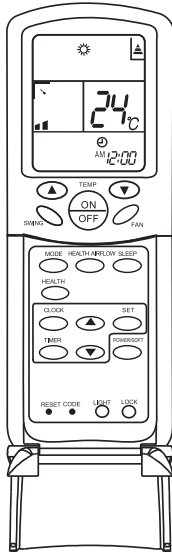

Vertical flap

- Pos.1
- Pos.2
- Pos.3
- Pos.4
- Pos.5
- Pos.6

2. Up and down air flow direction

For each press of button, air flow direction on remote controller displays as follows according to different operation modes:

COOL/DRY/FAN

remote controller: → Pos.1 → Pos.2 → Pos.3 → Pos.4 → Pos.6

HEAT:

remote controller: → Pos.5 → Pos.4 → Pos.3 → Pos.2 → Pos.1 → Pos.6

AUTO:

remote controller: → Pos.1 → Pos.2 → Pos.3 → Pos.4 → Pos.5 → Pos.6

The vertical flap will swing according to the above positions

Note: When restart after remote turning off, the remote controller will automatically memorize the previous set swing position.

Operation

Sleep Operation

Before going to bed, you can simply press the SLEEP button and unit will operate in SLEEP mode and bring you a sound sleep.

Use of SLEEP function

After the unit starts, set the operation status, then press SLEEP button before which the clock must be adjusted and time being set.

Operation Mode

1. In COOL, DRY mode

1 hours after SLEEP mode starts, temp. will become 1°C higher than temp. setting. After another 1 hours, temp. rises by 1°C further. The unit will run for further 6 hours then stops. Temp. is higher than temp. setting so that room temperature won't be too low for your sleep.

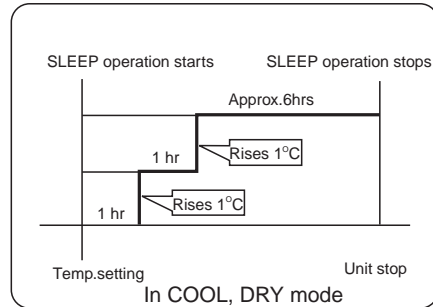

2. In HEAT mode

1 hours after SLEEP mode starts, temp will become 2 °C lower than temp. setting. After another 1 hours, temp decrease by 2 °C further. After more another 3 hours, temp. rises by 1°C further. The unit will run for further 3 hours then stops. Temp. is lower than temp. setting so that room temperature won't be too high for your sleep.

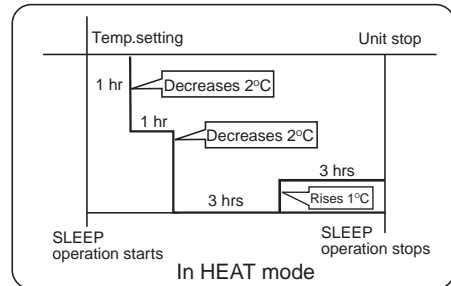

Remote Controller

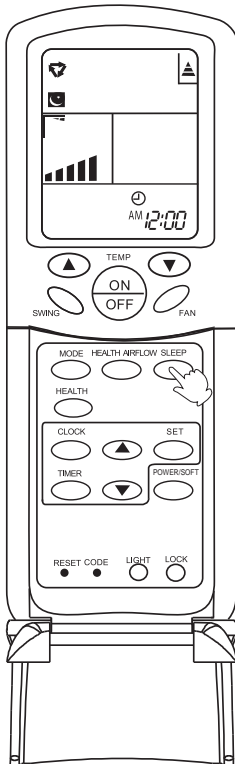

3. In AUTO mode

The unit operates in corresponding sleep mode adapted to the automatically selected operation mode.

4. In FAN mode

It has no SLEEP function.

5. Set the wind speed change when sleeping

If the wind speed is high or middle before setting for the sleep, set for lowering the wind speed after sleeping.

If it is low wind, no change.

Note

When TIMER function is set, the sleeping function can't be set up. After the sleeping function is set up, if user resets TIMER function, the sleeping function will be cancelled; the machine will be in the state of timing-on.

Operation

Timer On/Off Operation

Remote Controller

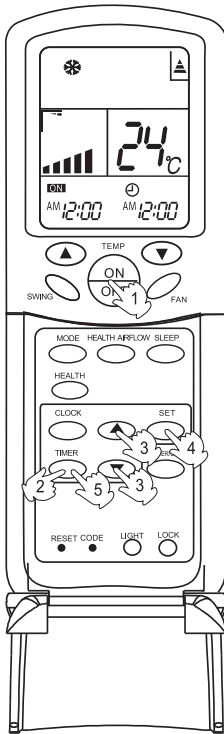

Set clock correctly before starting TIMER operation.

1. After unit starts, select your desired operation mode.

2. Timer mode selection

Press TIMER button to change TIMER mode. Every time the button is pressed, display changes as follows:
Remote controller:



Then select your desired TIMER mode (TIMER ON or TIMER OFF). " ON " or " OFF " will flash.

3. Time setting

Press HOUR Δ / ∇ button.

Δ Every time the button is pressed, time setting increases 1 min, if kept depressed, it will increase rapidly.

∇ Every time the button is pressed, time setting decreases 1 min, if kept depressed, it will decrease rapidly.

It can be adjusted within 24 hours.

4. Confirming your setting

After setting correct time, press SET button to confirm " ON " or " OFF " on the remote controller stops flashing.

Time displayed: Unit starts or stops at x hour x min. (TIMER ON or TIMER OFF).

5. Cancel TIMER mode

Just press TIMER button several times until TIMER mode disappears.

Hints:

After replacing batteries or a power failure happens, time setting should be reset.

Remote controller possesses memory function, when use TIMER mode next time,

just press SET button after mode selecting if time setting is the same as previous one.

Operation

Timer On-Off Operation

Remote Controller

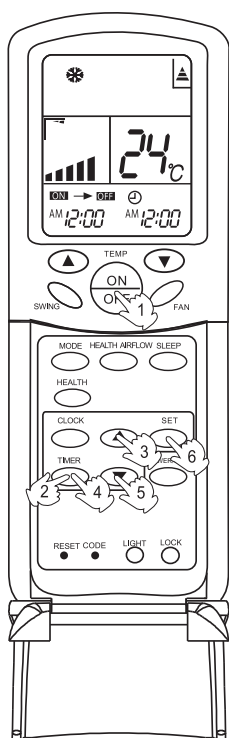

Set clock correctly before starting TIMER operation.

1. After unit starts, select your desired operation mode

2. Timer mode selection

Press TIMER button to change TIMER mode. Every time the button is pressed, display changes as follows:

Remote controller:



Then select your desired TIMER mode (TIMER ON - OFF).

" ON " will flash.

3. Time setting

Press HOUR Δ / ∇ button.

- Δ Every time the button is pressed, time setting increases 1 min, if kept depressed, it will increase rapidly.
- ∇ Every time the button is pressed, time setting decreases 1 min, if kept depressed, it will decrease rapidly. It can be adjusted within 24 hours.

4. Timer confirming for TIMER ON

After setting correct time, press TIMER button to confirm " ON " on the remote controller stops flashing.

" OFF " starts flashing.

Time displayed: Unit starts or stops at x hour x min.

5. Time setting for TIMER OFF

Just press HOUR button ,follow the same procedure in "Time setting for TIMER ON"

6. Time confirming for TIMER OFF

After time setting,press SET button to confirm.

" OFF " on the remote controller stops blinking.

Time displayed:Unit stops at x hour x min.

To cancel TIMER mode

Just press TIMER button several times until TIMER mode disappears.

According to the Time setting sequence of TIMER ON or TIMER OFF, either Start-Stop or Stop-Start can be achieved.

Operation

POWER/SOFT Operation

Remote controller

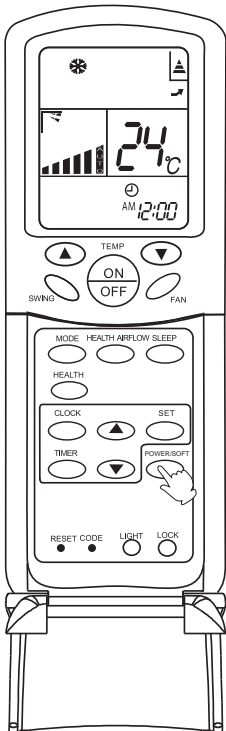

POWER Operation

When you need rapid heating or cooling, you can use this function.

Selecting of POWER operation

Press POWER/SOFT button. Every time the button is pressed, display changes as follows:



Stop the display at " ".

In POWER operation status:

In COOL mode, fan speed automatically takes high speed of AUTO fan mode.

In HEAT mode, fan speed automatically takes medial speed of AUTO fan mode.

To cancel POWER operation

Press POWER/SOFT button twice, POWER/SOFT disappears.

SOFT Operation

You can use this function when silence is needed for rest or reading.

Selecting of SOFT operation

Press POWER/SOFT button. Every time the button is pressed, display changes as follows:



Stop the display at " ".

In SOFT operation mode, fan speed automatically takes low speed of AUTO fan mode.

To cancel SOFT operation

Press POWER/SOFT button again, POWER/SOFT disappears.

Hints:

During POWER operation, in rapid HEAT or COOL mode, the room will show inhomogeneous temperature distribution.

Long period SOFT operation will cause effect of not too cool or not too warm.

Operation

Emergency and Test Operation

Emergency operation:

- Use this operation only when the remote controller is defective or lost.
- When the emergency operation switch is pressed, the "Pi" sound is heard once, which means the start of this operation.
- In this operation, the system automatically selects the operation modes, cooling or heating, according to the room temperature.
- When machine is running in emergency, the set value of temperature and wind speed couldn't be altered; meanwhile, it can't operate for dehumidifying or under timing mode.

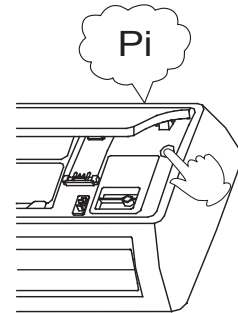

Test operation:

Test operation switch is the same as emergency switch.

- Use this switch in the test operation when the room temperature is below 16°C, do not use it in the normal operation.
- Continue to press the test operation switch for more than 5 seconds. After you hear the "Pi" sound twice, release your finger from the switch: the cooling operation starts with the air flow speed "Hi".

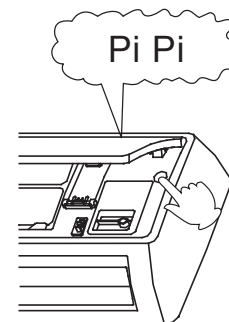

Removal of the restriction of emergency or test operation

- Press the emergency operation switch once more, or manipulate through the remote controller; the "Pi" sound, the emergency or test operation is terminated.
- When the remote controller is manipulated, it gets the system back to the normal operation mode.

Maintenance

For Smart Use of The Air Conditioner

Setting of proper room temperature

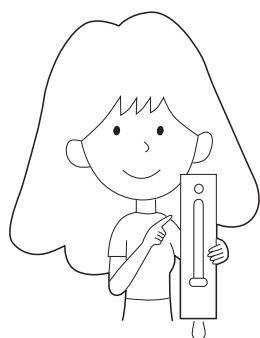

Proper temperature

Do not block the air inlet or outlet

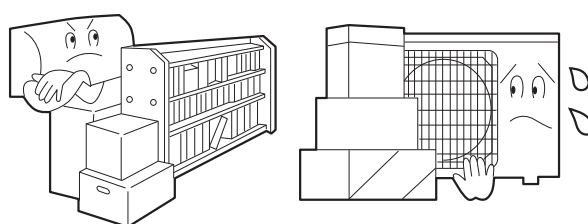

Close doors and windows during operation

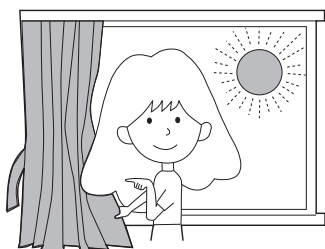

During cooling operation, prevent the penetration of direct sunlight with curtain or blind.

Use the timer effectively

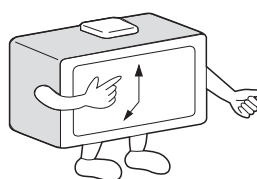
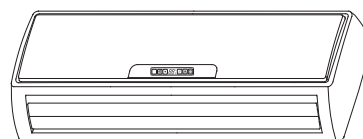

If the unit is not to be used for a long time, turn off the power supply main switch.

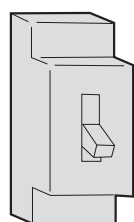

OFF

Use the louvers effectively

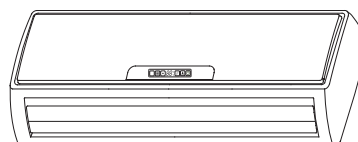

Maintenance

For Smart Use of The Air Conditioner

⚠ WARNING

Before maintenance, be sure to turn off the system and the circuit breaker.

Remote Controller



Do not use water, wipe the controller with a dry cloth. Do not use glass cleaner or chemical cloth.

Indoor Body

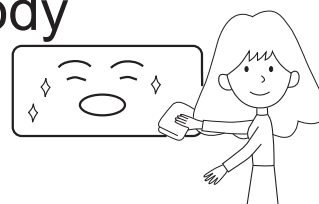

Wipe the air conditioner by using a soft and dry cloth. For serious stains, use a neutral detergent diluted with water. Wring the water out of the cloth before wiping, then wipe off the detergent completely.

Do not use the following for cleaning



Gasoline, benzene, thinner or cleanser may damage the coating of the unit.



Hot water over 40°C (104°F) may cause discoloring or deformation.

Air Filter cleaning

1 Open the inlet grille by pulling it upward.

2 Remove the filter.

Push up the filter's center tab slightly until it is released from the stopper, and remove the filter downward.

3 Clean the filter.

Use a vacuum cleaner to remove dust, or wash the filter with water. After washing, dry the filter completely in the shade.

4 Attach the filter.

Attach the filter correctly so that the "FRONT" indication is facing to the front. Make sure that the filter is completely fixed behind the stopper. If the right and left filters are not attached correctly, that may cause defects.

5 Close the inlet grille.

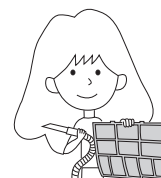
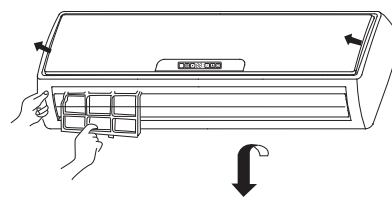

Once every two weeks

Maintenance

Replacement of Air Purifying Filter

1. Open the Inlet Grille

Prop up the inlet grille by using a small device named grille-support which located in the right side of the indoor unit.

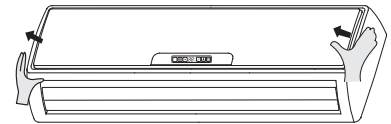

2. Detach the standard air filter

Slide the knob slightly upward to release the filter, then withdraw it.

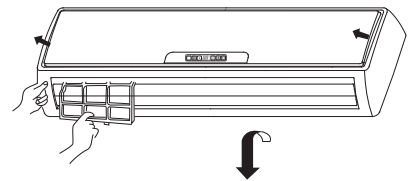

3. Attach Air Purifying Filter

Put air purifying filter appliances into the right and left filter frames.

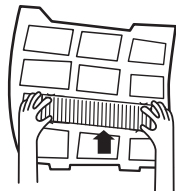

Detach old Air Purifying Filter

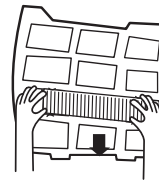

4. Attach the standard air filter (Necessary installation)

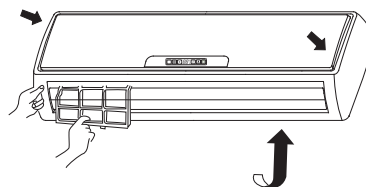

ATTENTION:

The white side of the photocatalyst air purifying filter face outside, and the black side face the unit.

The green side of the bacteria-killing medium air purifying filter face outside, and the white side face the unit.

5. Close the Inlet Grille

Close the Grille surely

NOTE:

- The photocatalyst air purifying filter and the bacteria-killing medium air purifying filter will be used based on real situation.
- The photocatalyst air purifying filter will be solarized in fixed time. In normal family, it will be solarized every 6 months.
- Please keep the bacteria-killing medium air purifying filter in the cool and dry conditions avoid long time directly sunshine when you stop using it, or its ability of sterilization will be reduced.

Maintenance

To Keep Your Air conditioner in Good Condition after Season.

1 Operate in cooling mode for 2-3 hours.

To prevent breeding mold or bad smell, be sure to operate at the designated temperature or 30°C, cooling mode and High speed fan mode for 2-3 hours.

2 Put off the power supply cord.

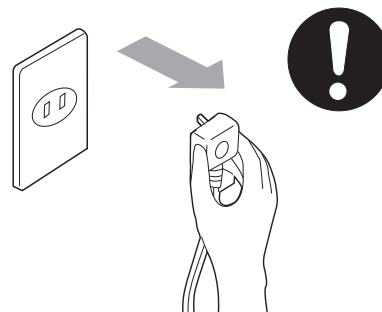

3 Cleaning the body.

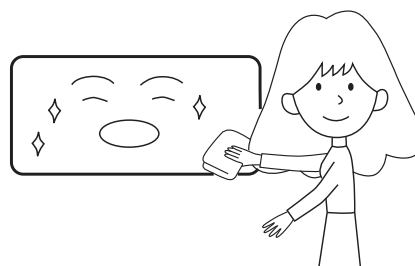

4 Take out the batteries from the wireless remote controller.

Maintenance

Before Setting in High season

1 Cleaning the standard air filter.

Operation without filter may cause troubles. Be sure to attach both right and left filters prior to the operation. Each of them are of different shapes.

2 Connecting the earthing cable.

⚠ Caution

- Incomplete earthing may cause an electric shock.

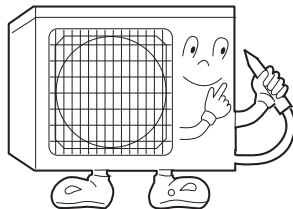

EARTHING

3 Do not block the air inlet or outlet.

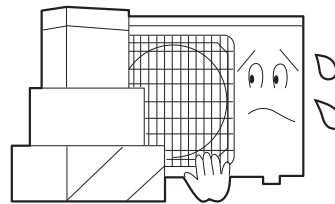
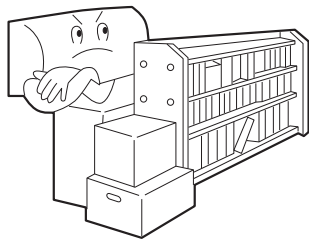

4 Plug-in

⚠ Caution



- After brush away dust at the plug, insert the plug of the power supply cord into the outlet completely. In case of using exclusive circuit breaker, switch on the circuit breaker.



NO WET HAND

Trouble shooting

Before asking for service, check the following first.

	Phenomenon	Cause or check points
Normal Performance inspection	<p>The system does not restart immediately.</p> 	<ul style="list-style-type: none"> • When unit is stopped, it won't restart immediately until 3 minutes have elapsed to protect the system. • When the electric plug is pulled out and reinserted, the protection circuit will work for 3 minutes to protect the air conditioner.
	<p>Noise is heard:</p> 	<ul style="list-style-type: none"> • During unit operation or at stop, a swishing or gurgling noise may be heard. At first 2-3 minutes after unit start, this noise is more noticeable. (This noise is generated by refrigerant flowing in the system.) • During unit operation, a cracking noise may be heard. This noise is generated by the casing expanding or shrinking because of temperature changes. • Should there be a big noise from air flow in unit operation, air filter may be too dirty.
	<p>Smells are generated.</p>	<ul style="list-style-type: none"> • This is because the system circulates smells from the interior air such as the smell of furniture, cigarettes.
	<p>Mist or steam are blown out.</p>	<ul style="list-style-type: none"> • During COOL or DRY operation, indoor unit may blow out mist. This is due to the sudden cooling of indoor air.
Multiple check	<p>Does not work at all.</p>	<ul style="list-style-type: none"> • Is power plug inserted? • Is there a power failure? • Is fuse blown out?
	<p>Poor cooling</p> 	<ul style="list-style-type: none"> • Is the air filter dirty? Normally it should be cleaned every 15 days. • Are there any obstacles before inlet and outlet? • Is temperature set correctly? • Are there some doors or windows left open? • Is there any direct sunlight through the window during the cooling operation?(Use curtain) • Are there too much heat sources or too many people in the room during cooling operation?

Haier