

## 7.Remote controller functions

### Remote controller

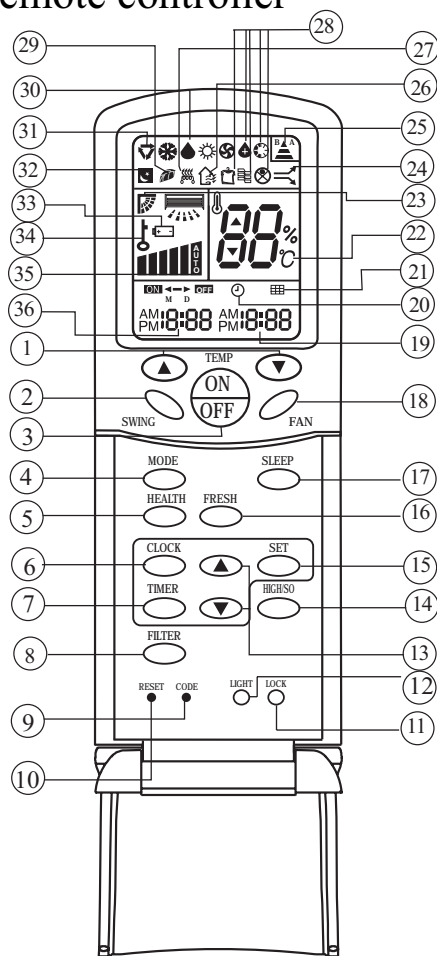

#### 1.TEMP Setting Button

(Used to set temperature. Setting ranges: 16°C to 30°C)

In Up/Down function, for controlling up and down filter.

#### 2.SWING Button

If you press this button once, auto swing will be activated.

If you press this button again, the louver will fix in the present position.

#### 3.Power ON/OFF Button

Used for unit start and stop

After power on, the LCD of remote controller will display the previous operation state (except for TIMER,SLEEP and SWING state).

#### 4.Operation MODE

Used to select operation mode.

Every time you press MODE button, operation mode changes according to following sequence:



#### 5.HEALTH Button

Used to set health mode, if the unit has the negative ion function and oxygen bar function.

#### 6.CLOCK Button

Used to set correct time.

#### 7.CLOCK Button

Used to select TIMER ON, TIMER OFF.

(Note: if time of TIMER ON is the same as TIMER OFF, TIMER ON/OFF cannot be set)

#### 8. FILTER Button

Used to set up/down function of filter.

#### 9. CODE Button

Used to select code A or B, for this unit, the code is B

#### 10.RESET Button

Press this button by using a sharp article to resume the correct operation of the remote controller in case of need, i.e. for example in case of malfunctions due to electromagnetic noise.

#### 11.LOCK Button

Used to lock operation button and LCD display contents: by pressing this button, other buttons comes out of function and lock state display appears; if you press it again, lock state will be no more active and lock state display will disappear.

#### 12.LIGHT Button

Used to light the control panel (only for cabinet unit)

#### 13.Up and down Button

Used to set TIMER and CLOCK up or down.

#### 14.HIGH/SO Button

Used to select HIGH or SOFT operation.

#### 15.SET Button

Used to confirm TIMER and CLOCK settings.

#### 16.FRESH Button

Used to set fresh mode, the unit will draw in fresh air.

#### 17.SLEEP Button

(The clock must be corrected before setting sleep function)

Used to set sleep mode.

**NOTE:** 1.Cooling only air conditioner does not have the displays and functions related to heating.

2.HIGH/SO button

This button is activated in Cooling/Heating mode, the fan speed is in AUTO mode after pressing it and "high function" will be cancelled automatically after 15 minutes running.

## 18.FAN Button

Used to select fan speed:LOW,MID,HIGH,AUTO.

## 19.TIMER OFF Display

## 20.CLOCK Display

## 21.FILTER Display

## 22.TEMPERATURE Display

## 23.AUTO SWING Display

## 24.HIGH/SO Display

## 25.SIGNAL SENDING Display

## 26.FRESH AIR Display

## 27.ELECTRICAL HEATING Display

## 28.Some other buttons

All these functions are not available now.

## 29.HEALTH Display

Displays when healthy run function is set.

## 30.DEHUMIDIFICATION Display

## 31.Operation MODE Display

AUTO RUN	COOL RUN	DRY RUN	HEAT RUN	FAN RUN
				

## 32.SLEEP State Display

## 33.BATTERY Energy Display

Notify the user when it is time to change the batteries.

## 34.LOCK State Display

## 35.FAN SPEED Display

LO		
MID		
HI		
AUTO		

## 36.TIMER ON Display

### Remote Controller' Operation

- When in use, direct signal transmission head to the receiver placed on the indoor unit

- The distance between the remote controller and the receiver should be max 7m and there should be no obstacle between them.
- Do not throw the remote controller; prevent it from being damaged.
- When operating the remote controller in an area where electronically controlled lights are installed or wireless handsets are used, please move closer to the indoor unit as the function of the remote controller might be affected by signals emitted by the above mentioned equipments.

## Battery loading

Battery loading

Batteries are fitted as follows:

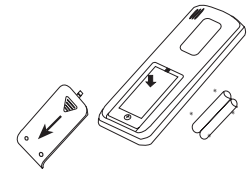

Remove the battery compartment lid

Slightly press and disengage the battery compartment lid marked with  and then hold the remote controller by the upper section and then remove the battery compartment lid by pressing in the direction of the arrow as shown in the figure above.

### Loading the battery

Ensure that batteries are correctly placed in the compartment as required for positive and negative terminals.

### Replacing the battery compartment lid

The battery compartment lid is reinstalled in the reverse sequence.

### Display review

Press the button to see if batteries are properly fitted. If no display appears, refit the batteries.

### Confirmation indicator

If no indication is displayed after press ON/OFF button, reload the batteries.

Caution:

If the remote controller does not operate as designed after fitting new batteries of the same type, press the Reset button (marked ) with a pointed article.



Note:

It is recommended that the batteries be removed from the compartment if the remote controller is not used for an extended period.

The remote controller is programmed for automatic test of operation mode after the batteries are replaced. When the test is conducted, all icons will appear on the screen and then disappear if the batteries are properly fitted.

### Clock Set

When unit is started for the first time and after replacing batteries in remote controller, clock should be adjusted as follows:

- 1.Press CLOCK button, clock indication of " AM " or " PM " flashes.
- 2.Press  or  to set correct time. Each press will increase or decrease 1 min. If the button is kept pressed, time will increase or decrease quickly.
- 3.After time setting is confirmed, press "SET" : AM or PM stop flashing, while clock starts working.

Note:AM means morning and PM means afternoon.

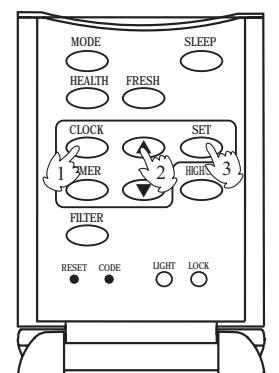

# Fan Operation

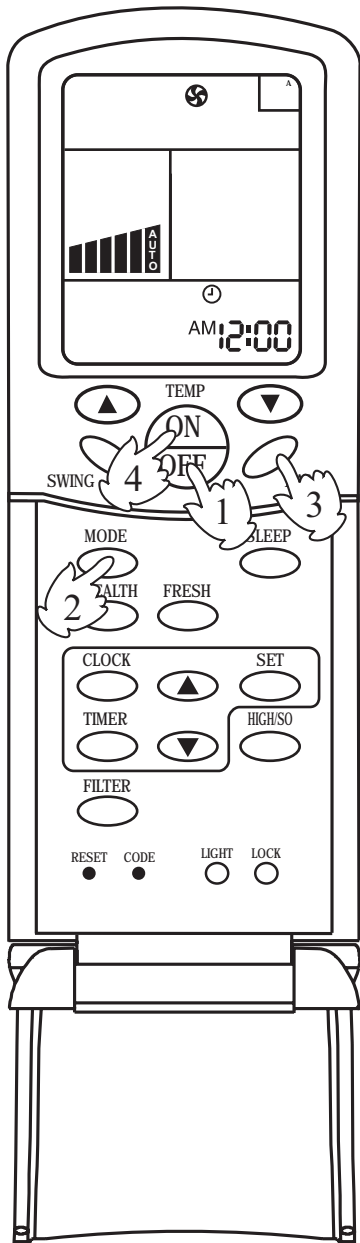

## 1. Unit start

Press ON/OFF button to start your air conditioner. Previous operation status appears on LCD (except for TIMER, SLEEP, and SWING setting).

## 2. Select operating mode

Press MODE button. At each press, operation mode changes as follows:



Then select FAN

## 3. Adjust fan speed

Press FAN button. At each press, fan speed changes as follows:



Air conditioner will run at the selected fan speed. When in AUTO mode, unit will adjust fan speed according to room temperature automatically.

## 4. Unit stop

Press ON/OFF button to stop unit.

## About FAN mode

When the air conditioner runs in FAN mode, it is not possible to select AUTO FAN or to set temperature.

# AUTO, COOL , HEAT and DRY Operation

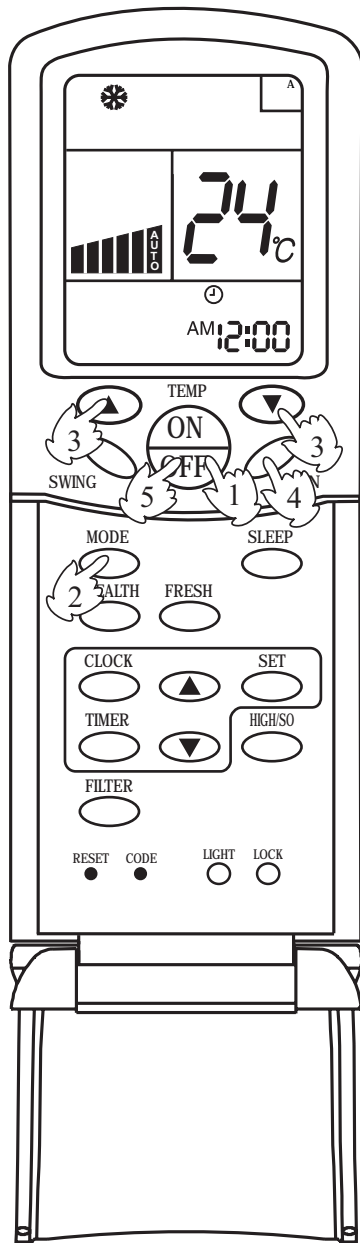

## 1. Unit start

Press ON/OFF button, unit starts.

Previous operation status appears on LCD (except for TIMER, SLEEP and SWING setting)

## 2. Select operation mode

Press MODE button. At each press, operation mode changes as follows:



Then select AUTO run or select COOL operation or select DRY operation or select HEAT operation

## 3. Temperature setting

Press TEMP button.

▲ Every time the button is pressed, temp. setting increases 1 °C; if the button is kept pressed, temp. setting will increase quickly.

▼ Every time the button is pressed, temp. setting decreases 1 °C, if the button is kept pressed, temp. setting will decrease quickly.

Set proper temperature

## 4. Adjust FAN button

Press FAN button. At each press, fan speed changes as follows:

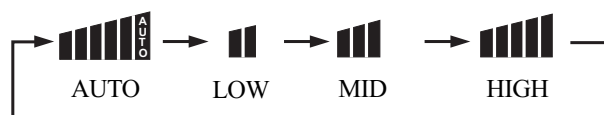

Air conditioner will run at the selected fan speed.

## 5. Unit stop

Press ON/OFF button, unit stops.

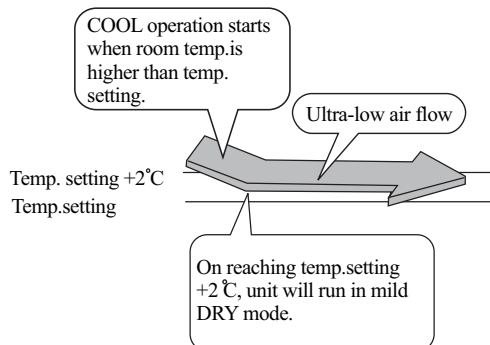

In ATUO mode, the temperature setting is not displayed on LCD. In this mode, during running air conditioner will select COOL, HEAT or FAN mode automatically according to the room temperature.

In DRY mode, when room temperature becomes 2 °C higher than temperature setting, unit will run intermittently at LOW speed regardless of FAN setting. When room temperature is lower than temperature setting, unit will only run FAN operation.

In HEAT mode, warm air will blow out after a short period of time due to cold-draft prevention function.

## Adjusting air flow direction

### AUTO SWING

Press SWING button.

Up and down airflow varies upwards and downwards. Left and right airflow varies left and right sides.

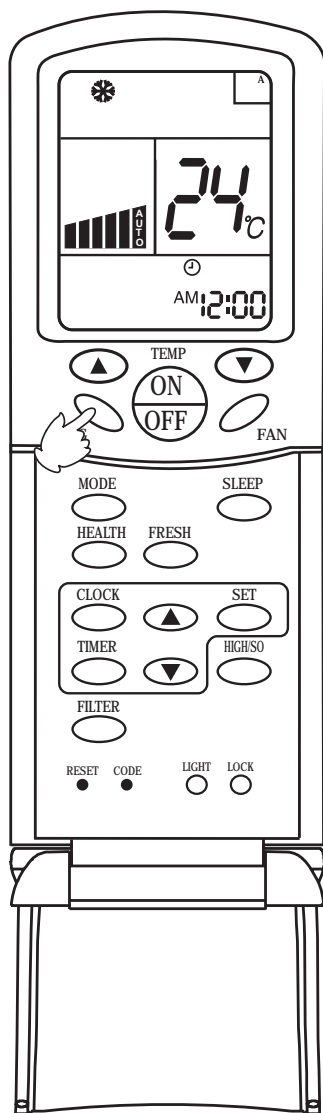

### AUTO SWING

When the automatic swing louver moves to the proper angle, press SWING button can fix the airflow direction.

- Always use SWING button on the remote controller to adjust flaps. Adjusting them by hand may result in air conditioner's abnormally running.
- In COOL or DRY mode, do not leave the louver in downward position for a long time, as the water vapor close to the grille may condense and water may drop from the air conditioner.
- Please carefully set temperature when children, old or infirm people use the air conditioner.
- In case of great humidity, if the vertical flaps are completely turned towards left or right, the louver will drop water.
- Never adjust the louver directly by hand, as this could make it work abnormally. If the louver works abnormally, stop unit, restart and adjust the louver by remote controller.

After unit stops:

Displays on the LCD disappear.

All indicators on the indoor unit go out.

Swing louver automatically close the air outlet.

### Hints:

As in COOL mode air flows downwards, adjusting airflow horizontally will be much more helpful for a better air circulation

As in HEAT mode air flows upwards, adjusting airflow downward will be much more helpful for a better air circulation.

Be careful not to catch a cold when cold air blows downward directly.

## Sleep Function

Before going to bed you can press down the SLEEP button and the air conditioner will run so as to make you sleep more comfortably.

Before using this function, the clock must be set.

## Use of SLEEP function

After the unit's start, set running mode and then press SLEEP button once to make the air conditioner have the previous-set sleep time (first power-on is "1h"). The sleep symbol will appear. Press time button ▲/▼: you can choose the time in 1~8 hours. Each time the button is pressed, the time increases/decreases 1 hour: "xh" and "OFF" indications appear on the display.

## Operation Mode

### 1. In COOL, DRY mode

One hour after sleeping operation start, the temperature is 1 °C higher than the setting one. After another hour, temperature rises 1 °C: sleep run continuously for another 6 hours and then stops. The actual temperature is higher than the setting one which is to prevent from being too cold to your sleep.

### 2. In HEAT mode

One hour after sleeping operation start, the temperature is 2 C lower than the setting one. After another hour, temperature decreases by 2 C more. Temperature will automatically rise by 1 C after another 3 hours' continuous operation. The actual temperature is lower than the setting one which is to prevent from being too hot to your sleep.

### 3. In AUTO mode.

The air conditioner will run in corresponding sleep operation according to the automatically selected operation mode.

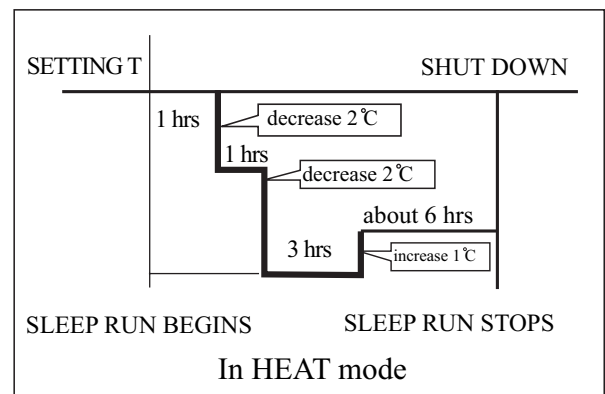
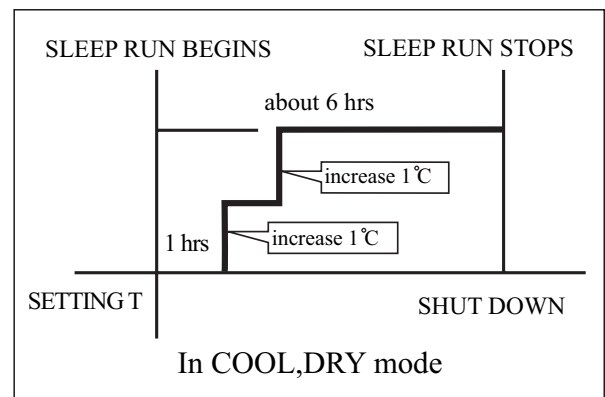

### Notes:

- After setting SLEEP function, it is not possible to set clock.
- If set-sleep time does not reach 8 hours, unit will automatically stop operation after set time is reached.
- Set "TIMER ON" or "TIMER OFF" in COOL, DRY mode function first, then set SLEEP. After set SLEEP function, the TIMER function cannot be set.

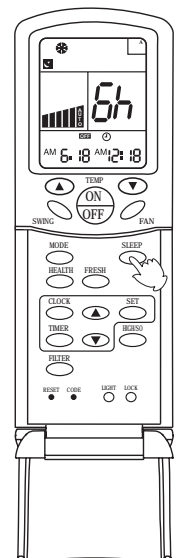

# Timer ON/OFF Function

Set clock correctly before starting TIMER operation

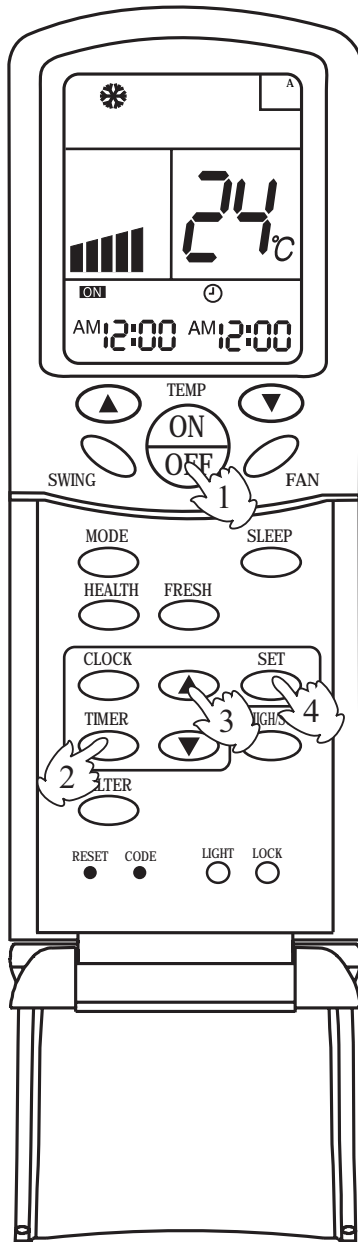

## 1. Unit start

After unit start, select your desired operation mode (operation mode will be displayed on LCD)

## 2. TIMER mode selection

Press TIMER button on the remote controller to change TIMER mode. Every time the button is pressed, display of TIMER mode changes as follows:



Then select TIMER mode as needed (TIMER ON or TIMER OFF). Now **ON** or **OFF** will flash.

## 3. TIMER setting (press time adjust buttons ⬆️)

- ▲ Every time the button is pressed, time increases 10 mins. If the button is kept pressed, time changes quickly.
- ▼ Every time the button is pressed, time decreases 10 mins. If the button is kept pressed, time changes quickly. It can be adjusted within 24 hours at will.

## 4. Confirm setting

After setting correct time, press SET button to confirm time. Now **ON** or **OFF** stop flashing.

Time displayed: unit starts or stops at X hour X min (TIMER ON or TIMER OFF)

## 5. Cancel TIMER mode

Just press TIMER button several times until TIMER mode disappears.

## Hints:

After replacing batteries or if a power failure occurs, TIMER setting must be reset.

Remote controller has memory function. When you use TIMER mode next time, just press SET button after mode selection if timer setting is the same as the previous one.

## Note:

After setting TIMER function, the remote controller displays TIMER time. If you want to see clock time, just press CLOCK button once: clock time will be displayed (if you press the button again continuously, you can adjust clock). 5 seconds later, the display will show TIMER time again.

# Timer ON-OFF Function

Set clock correctly before starting TIMER operation

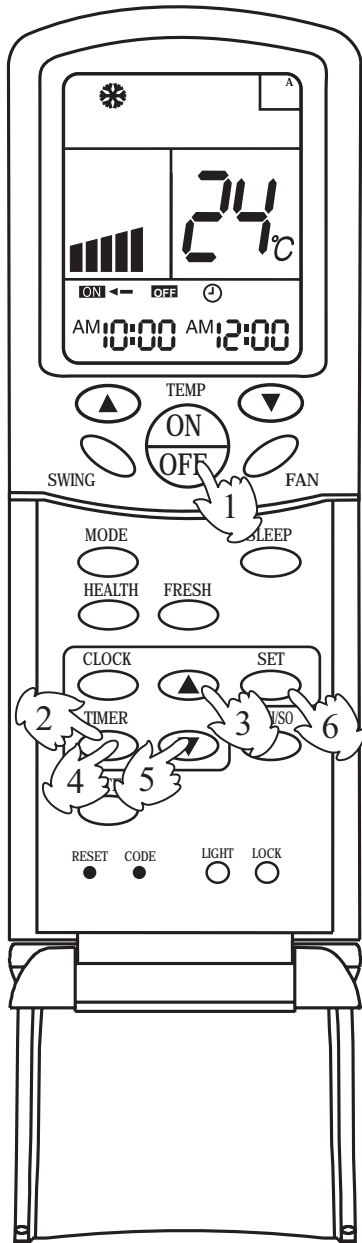

## 1. Unit start

After unit start, select your desired operation mode (operation mode will be displayed on LCD)

## 2. TIMER mode selection

Press TIMER button on the remote controller to change TIMER mode. Every time the button is pressed, display of TIMER mode changes as follows:



Then select TIMER ON-OFF mode. **ON** will flash.

## 3. Time setting for TIMER ON

Press time button  $\blacktriangle$

$\blacktriangle$  Every time the button is pressed, time increases 10 minutes. If the button is kept pressed, time will change quickly.

$\blacktriangledown$  Every time the button is pressed, time decreases 10 minutes. If the button is kept pressed, time will change quickly. It can be adjusted within 24 hours at will. AM refers to morning and PM refers to afternoon.

## 4. Timer confirming for TIMER ON

After setting correct time, press TIMER button to confirm time. Now **ON** stops to flash, while **OFF** starts flashing.

Time displayed : unit starts at X hour X min.

## 5. Timer setting for TIMER OFF

Press time buttons  $\blacktriangle$  and follow the same procedures in " Time setting for TIMER ON"

## 6. Time confirming for TIMER OFF

After time setting, press SET button to confirm time. **OFF** stops to flash.

Time displayed: unit starts at X hour X min.

## 7. Canel TIMER mode

Just press TIMER button several times until TIMER mode disappears.

According to the time setting sequence of TIMER ON and TIMER OFF, either start-stops or stops-start can be realized.

If the time setting of TIMER ON is the same as TIMER OFF, TIMER ON-OFF function cannot be set.



## Filter Up/Down

(Only for 600\*600 panel of single unit)

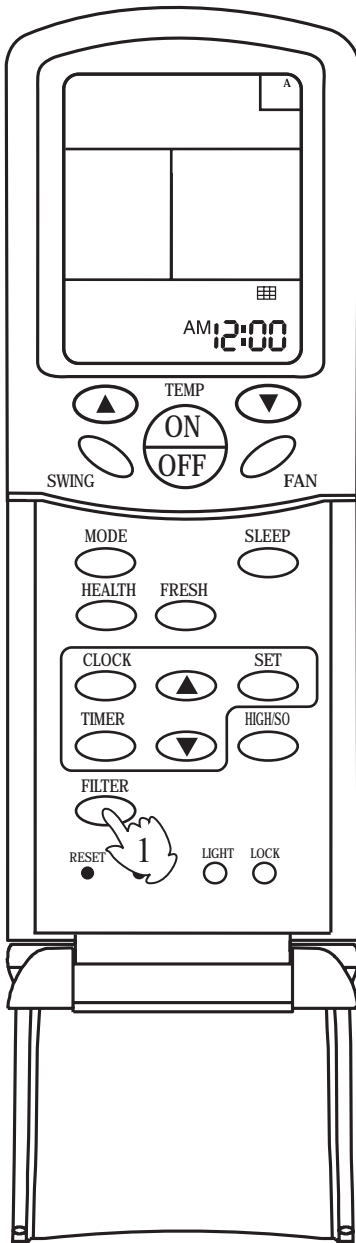

After the air conditioner has operated for a certain period, dust has accumulated on the filter, and the filter up/down function can be used to clean it.

1. Whether unit starts or stops, continuously press FILTER button for 3 seconds, and enter the filter up/down waiting status (when unit stops, the yellow TIMER indicator flashes, and filter and clock indication are displayed on the remote controller. Only the FILTER button, the temperature buttons "△" "▽" and time buttons ◆ are active).
2. Press temperature "▽" button or time "▼" button in filter up/down waiting status: the up/down mechanism makes the filter moving downward and does not stop until it has reached the maximum limit.
3. Press temperature "△" button or time "▲" button in filter up/down waiting status: the up/down mechanism makes the filter to moving upward till near the surface board and then automatically adjusts it to reset (when adjusting to reset, it will not be controlled by the remote controller till the adjustment is finished).
4. During moving downward, press temperature "△" button or time "▲" button: moving stops.
5. During moving downward, press temperature "▽" button or time "▼" button: moving stops.
6. Continuously press FILTER button 3 seconds again to cancel the filter up/down waiting mode (unit stops, the yellow timer indicator stops flashing, the filter goes back to the original position, the remote controller goes back to off status and only clock is displayed).

### Note:

If the filter does not thoroughly go back to the original position, only needs to operate several times repeatedly.

## " High mode " Operation

### Outline of operation in "High Mode"

This function is suitable when the set temperature must be reached in the shortest delay.

The button "HIGH/SO", referred to this function, is effective in Cooling/Heating mode (not in Auto/Dry/Fan modes).

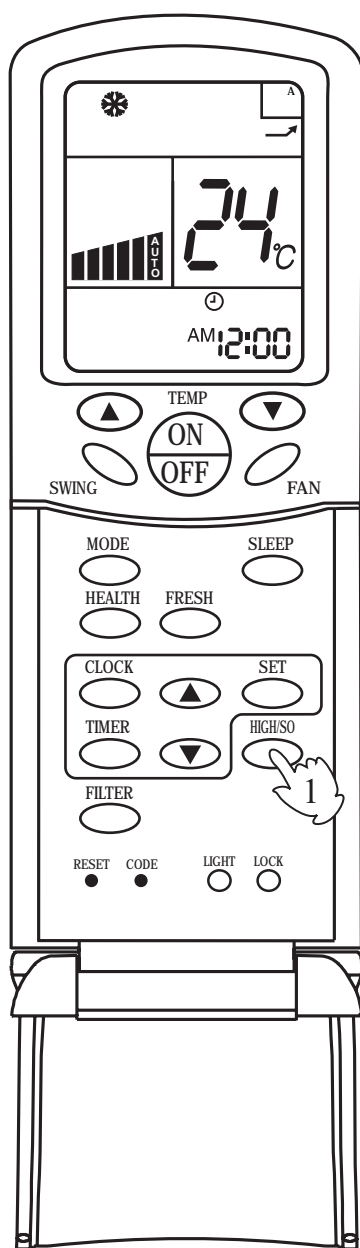

### ON

#### Press the HIGH/SO button once

The indication  appears on the display of the remote controller and operation in "High Mode" starts.

The AUTO fan speed is automatically set and the corresponding indication is also displayed.

### OFF

#### Press the HIGH/SO button twice

If the button is pressed once, the indication  is displayed on the remote controller. If you press the button once again, the indication disappears, regular operation is restored and fan speed goes back to the mode set before "High Mode" operation.

### NOTICE:

- When the air conditioner is operating in " High Mode ", unevenness of room air temperature may occur due to the intensive operation in a short time.
- Anyway, operation in "High Mode", does not last for more than 15 minutes, then regular operation is automatically restored.

## " Soft mode " Operation

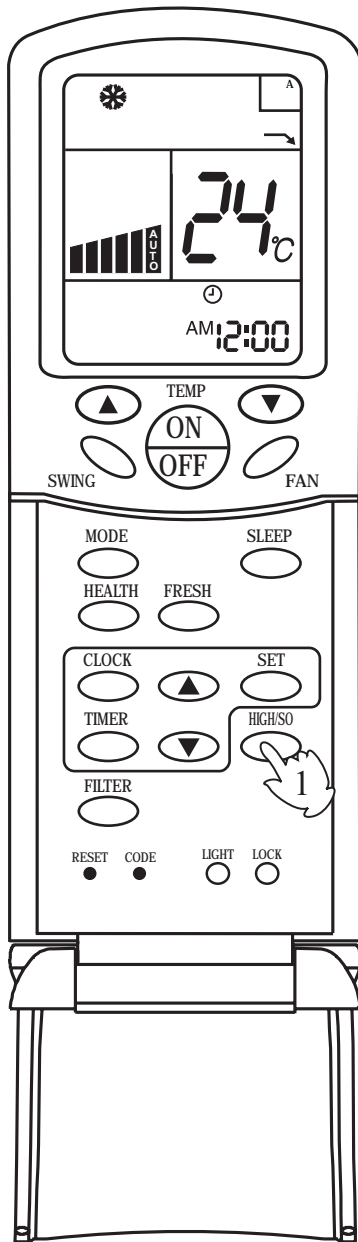

### Outline of operation in "Soft Mode"

Operation in "Soft Mode", more silent, is suitable when noises should be reduced, e.g.. for reading or sleeping.

The button "HIGH/SO", referred to this operation, is effective in Cooling/Heating mode (not in Auto/Dry/Fan modes).

### ON

#### Press the HIGH/SO button twice

The indication  appears on the display of the remote controller and operation in "Soft Mode" starts.

The AUTO fan speed is automatically set and the corresponding indication is also displayed.

### OFF

#### Press the HIGH/SO button twice

If the button is pressed once, the indication  is disappears from the remote controller's display. If you press the button once again, regular operation is restored and fan speed goes back to the mode set before "Soft Mode" operation.

### NOTICE:

- When the air conditioner is operating in " High Mode " , unevenness of room air temperature may occur due to the intensive operation in a short time.
- Anyway, operation in "High Mode", does not last for more than 15 minutes, then regular operation is automatically restored.

## Auto restart function setting

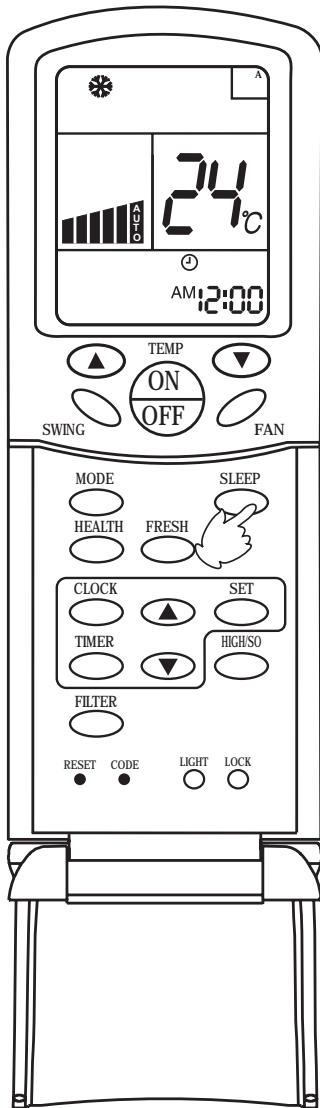

### Setting method (to be applied for a necessary situation) :

After the auto restart function is set, if power failure suddenly occurs while the air conditioner is working, it will resume the previous working state when the power is supplied again.

**Setting Method:** When the remote controller is on (excluding timer mode and fan mode), press the "SLEEP" button on the remote controller 10 times within 5 seconds, and after the buzzer rings 4 times, the air conditioner will enter the state of auto restart.

**Cancel Method:** Press the "SLEEP" button on the remote controller 10 times within 5 seconds, and after the buzzer rings 2 times, the auto restart function will be cancelled.

**Notes:** When a power failure suddenly occurs during the air conditioner is working after the auto restart function is set, if the air conditioner will not be used for a long time, please cut off the power supply to prevent its operation from being resumed after the power is supplied again, or press the "Switch On/Off" button after the power comes again.

### 7.1.4 Wired remote controller (new type)

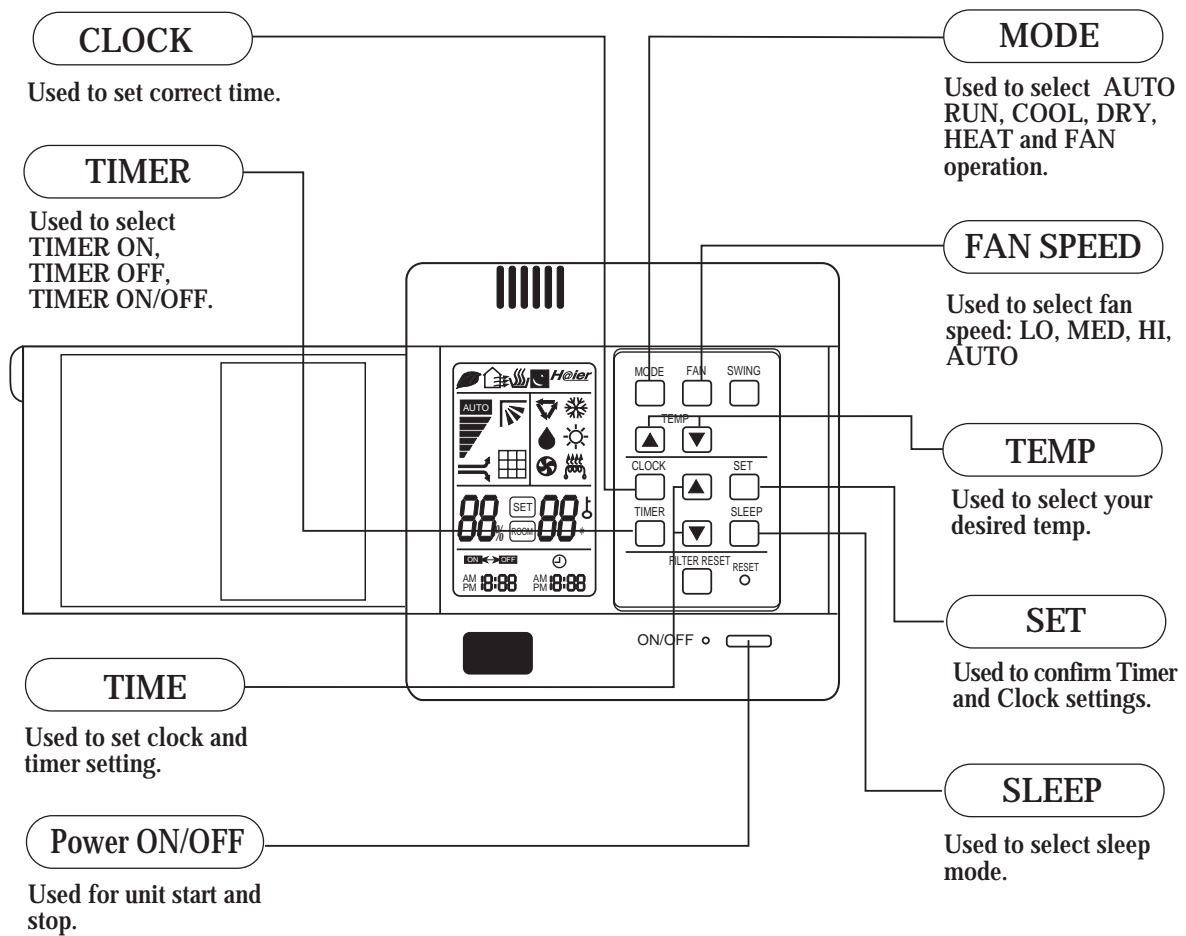

**Note:**

The above information is the explanation of the displayed information therefore varies with those displayed in actual operation.

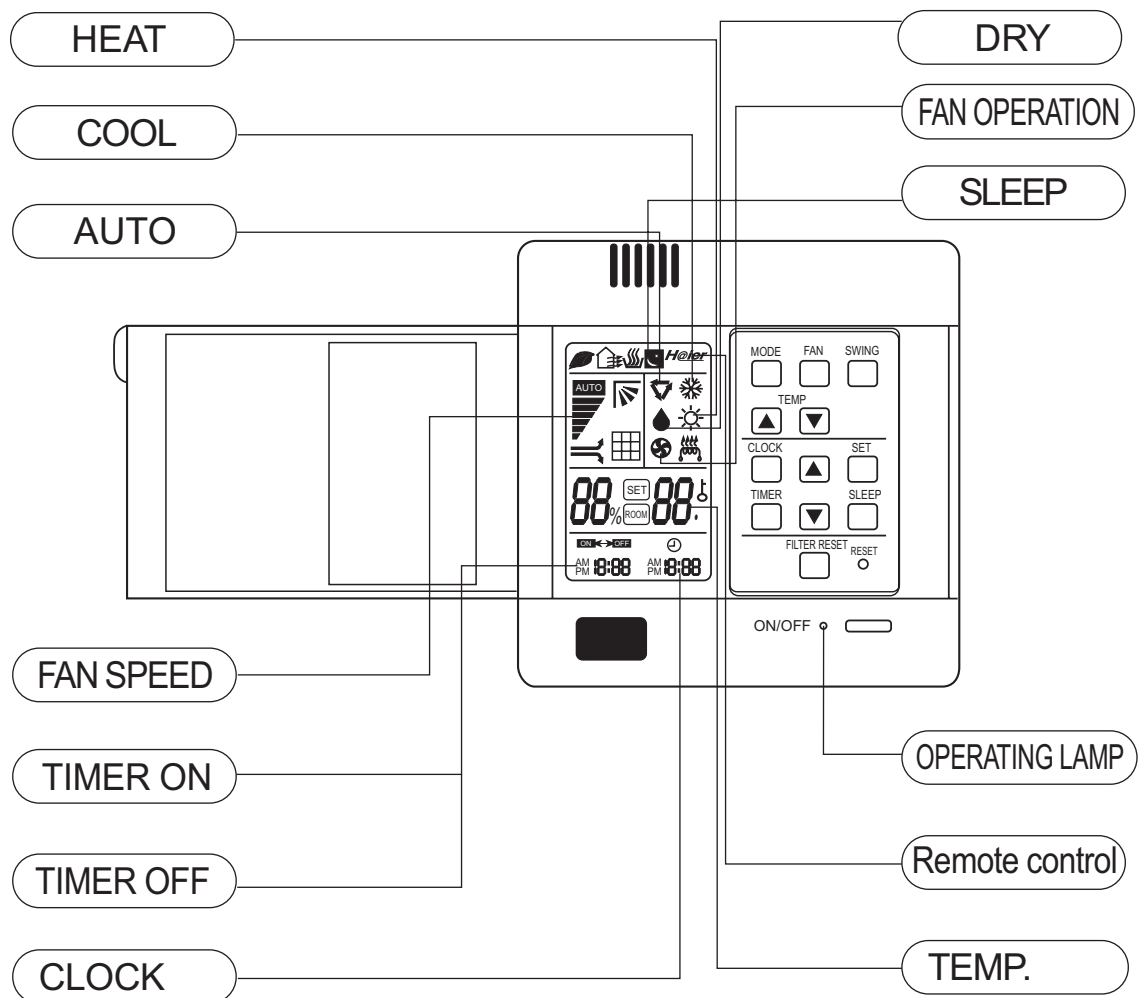

### Clock set

When unit is started for the first time, clock should be adjusted as follows:

- Press CLOCK button, "AM" or "PM" flashes.
- Press ▲ or ▼ to set correct time. Each press will increase or decrease 1min. If the button is kept depressed, time will change quickly.
- After time setting is confirmed, press SET, "AM" and "PM" stop flashing, while clock starts working.