

Haier

SPLIT TYPE ROOM AIR CONDITIONER OPERATION MANUAL AND INSTALLATION GUIDE



AS07GS1ERA
AS09GS1ERA
AS12GS1ERA

Contents

PARTS AND FUNCTIONS	1
OPERATION	2
INDOOR UNIT INSTALLATION	5
MAINTENANCE	8
CAUTIONS	9
TROUBLE SHOOTING	10

English

Italiano

- Please read this operation manual before using the air conditioner.
Keep this operation manual for future reference.

Parts and Functions

Indoor Unit

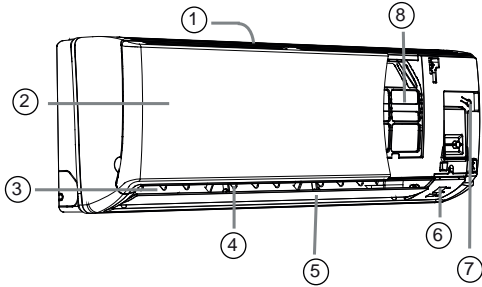

- ① Inlet
- ② Inlet grille
- ③ Outlet
- ④ Vertical blade (adjust left and right air flow)
- ⑤ Horizontal flap (adjust up and down air flow. Don't adjust it manually)
- ⑥ Display board
- ⑦ Emergency Switch
- ⑧ Air Purifying Filter (inside)

Please be subject to the actual produce purchased the above picture is just from your reference

Outdoor Unit

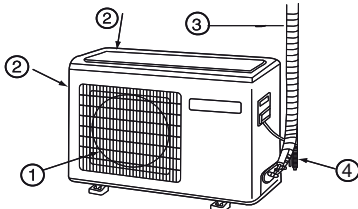

- ① OUTLET
- ② INLET
- ③ CONNECTING PIPING AND ELECTRICAL WIRING
- ④ DRAIN HOSE

Please be subject to the actual produce purchased the above picture is just from your reference

Clock set

Press CLOCK button, "AM" or "PM" flashes.
Press Δ or ∇ to set correct time. Each press will increase or decrease 1min. If the button is kept pressed, time will change quickly. After time setting is confirmed, press SET, "AM" and "PM" stop flashing, while clock starts working.



Remote controller

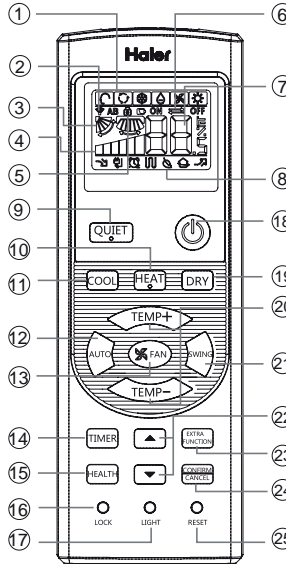

8. Additional functions display

Operation mode	QUIET	SLEEP	Supplemented electrical heating	HEALTH	POWER
Remote controller					

- 9. QUIET button
- 10. HEAT button
- 11. COOL button
- 12. AUTO button
- 13. FAN button
- 14. TIMER button
- 15. HEALTH button
- 16. LOCK button
- 17. LIGHT button
- 18. POWER ON/OFF button
- 19. DRY button
- 20. TEMP button
- 21. SWING button
- 22. HOUR button
- 23. EXTRA FUNCTION button
- 24. CANCEL/CONFIRM button
- 25. RESET button

- 1. Mode display
- 2. Signal sending display
- 3. SWING display
- 4. FAN SPEED display
- 5. LOCK display
- 6. TIMER OFF display
- 7. TEMP display

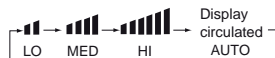

Healthy function is not available for some units.

Loading of the battery

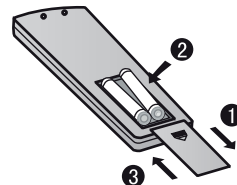

- 1 Remove the battery cover;
- 2 Load the batteries as illustrated. 2 R-03 batteries, resetting key (cylinder);
- 3 Be sure that the loading is in line with the "+" and "-" ;
- 4 Load the battery, then put on the cover again.

- Note:
- The distance between the signal transmission head and the receiver hole should be within 7m without any obstacle as well.
 - When electronic-started type fluorescent lamp or change-over type fluorescent lamp or wireless telephone is installed in the room, the receiver is apt to be disturbed in receiving the signals, so the distance to the indoor unit should be shorter.
 - Full display or unclear display during operation indicates the batteries have been used up. Please change batteries.
 - If the remote controller can't run normally during operation, please remove the batteries and reload several minutes later.

Hint:
Remove the batteries in case won't be in use for a long period. If there is any display after taking-out, just press reset key.

Operation

Base Operation

Remote controller

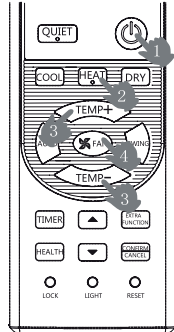

- Unit start**
Press ON/OFF on the remote controller, unit starts.
- Select operation mode**
COOL button: Cooling mode
HEAT button: Heating mode
DRY button: Dehumidify mode
- Select temp.setting**
Press TEMP+ / TEMP- button
TEMP+ Every time the button is pressed, temp.setting increase 1°C, if kept depressed, it will increase rapidly
TEMP- Every time the button is pressed, temp.setting decrease 1°C, if kept depressed, it will decrease rapidly
Select a desired temperature.
- Fan speed selection**
Press FAN button. For each press, fan speed changes as follows:
Remote controller:



Air conditioner is running under displayed fan speed. When FAN is set to AUTO, the air conditioner automatically adjusts the fan speed according to room temperature.

Operation Mode	Remote Controller	Note
AUTO		Under the mode of auto operation, air conditioner will automatically select Cool or Heat operation according to room temperature. When FAN is set to AUTO the air conditioner automatically adjusts the fan speed according to room temperature.
COOL		
DRY		In DRY mode, when room temperature becomes lower than temp.setting+2° C, unit will run intermittently at LOW speed regardless of FAN setting.
HEAT		In HEAT mode, warm air will blow out after a short period of the time due to cold-draft prevention function. When FAN is set to AUTO, the air conditioner automatically adjusts the fan speed according to room temperature.
FAN		In FAN operation mode, the unit will not operate in COOL or HEAT mode but only in FAN mode, AUTO is not available in FAN mode. And temp. setting is disabled. In FAN mode, sleep operation is not available.

Emergency operation and test operation

Emergency Operation:

- Use this operation only when the remote controller is defective or lost, and with function of emergency running, air conditioner can run automatically for a while.
- When the emergency operation switch is pressed, the " Pi " sound is heard once, which means the start of this operation.
- When power switch is turning on for the first time and emergency operation starts, the unit will run automatically in the following modes:

Room temperature	Designated temperature	Timer mode	Fan speed	Operation mode
Above 23°C	26°C	No	AUTO	COOL
Below 23°C	23°C	No	AUTO	HEAT

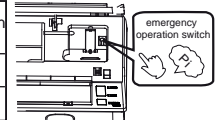

- It is impossible to change the settings of temp. and fan speed, It is also not possible to operate in timer or dry mode.

Test operation:

Test operation switch is the same as emergency switch.

- Use this switch in the test operation when the room temperature is below 16°C, do not use it in the normal operation.
- Continue to press the test operation switch for more than 5 seconds. After you hear the "Pi" sound twice, release your finger from the switch: the cooling operation starts with the air flow speed "Hi".
- Under this operation mode, the fan motor of indoor unit will run in high speed.

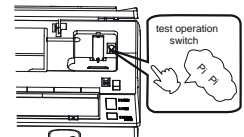

Air Flow Direction Adjustment

1. Status display of air flow

COOL/DRY:

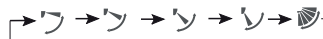

HEAT:



2. Left and right air flow adjustment (manual)

Move the vertical blade by a knob on air conditioner to adjust left and right direction referring to Fig.



Cautions:

- When adjusting the flap by hand, turn off the unit.
- When humidity is high, condensate water might occur at air outlet if all vertical louvers are adjusted to left or right.
- It is advisable not to keep horizontal flap at downward position for a long time in COOL or DRY mode, otherwise, condensate water might occur.

Note:

When restart after remote turning off, the remote controller will automatically memorize the previous set swing position.

Operation

Sleep Operation

Before going to bed, you can simply press the SLEEP button and unit will operate in SLEEP mode and bring you a sound sleep.



Use of SLEEP function

After the unit starts, set the operation status, then press SLEEP button before which the clock must be adjusted and time being set.

Operation Mode

1. In COOL, DRY mode

1 hours after SLEEP mode starts, temp. will become 1°C higher than temp. setting. After another 1 hours, temp. rises by 1°C further. The unit will run for further 6 hours then stops. Temp. is higher than temp. setting so that room temperature won't be too low for your sleep.

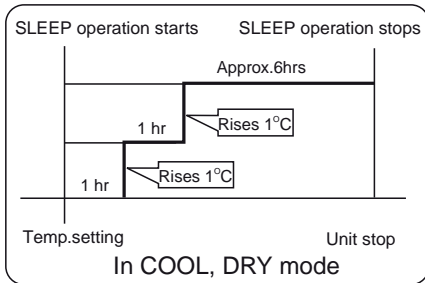

2. In HEAT mode

1 hours after SLEEP mode starts, temp will become 2°C lower than temp. setting. After another 1 hours, temp decrease by 2°C further. After more another 3 hours, temp. rises by 1°C further. The unit will run for further 3 hours then stops. Temp. is lower than temp. setting so that room temperature won't be too high for your sleep.

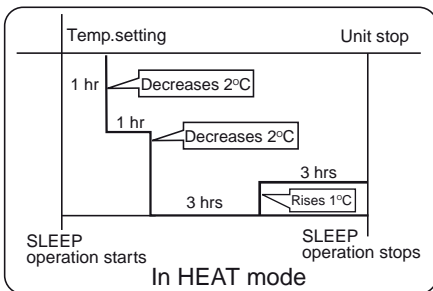

3. In AUTO mode

The unit operates in corresponding sleep mode adapted to the automatically selected operation mode.

4. In FAN mode

It has no SLEEP function.

5. When quiet sleeping function is set to 8 hours,

the quiet sleeping time can not be adjusted. When TIMER function is set, the quiet sleeping function can't be set up. After the sleeping function is set up, if user resets TIMER function, the sleeping function will be cancelled; the machine will be in the state of timing-on, if the two modes are set up at the same time, either of their operation time is ended first, the unit will stop automatically, and the other mode will be cancelled.

Power Failure Resume Function

1. If the unit is started for the first time, the compressor will not start running unless 3 minutes have elapsed. When the power resumes after power failure, the unit will run automatically, and 3 minutes later the compressor starts running.

2. Note to the power failure resume: press the sleep button ten times in five seconds and enter this function after hearing four sounds. And press the sleep button ten times within five seconds and leave this function after hearing two sounds.

POWER/SOFT Operation

(1) POWER Operation

When you need rapid heating or cooling, you can use this function. In COOL mode, fan speed automatically takes high speed of AUTO fan mode. In HEAT mode, fan speed automatically takes medium speed of AUTO fan mode.

(2) SOFT Operation

You can use this function when silence is needed for rest or reading. In SOFT operation mode, fan speed automatically takes low speed of AUTO fan mode.

Note:

During POWER operation, in rapid HEAT or COOL mode, the room will show uniform temperature distribution. Long period SOFT operation will cause effect of not too cool or not too warm.

To cancel POWER or SOFT operation

Press POWER/SOFT button again, POWER or SOFT disappears.

Operation

■ Timer On/Off On-Off Operation

Set clock correctly before starting TIMER operation.
 1. After unit starts, select your desired operation mode.
 2. Press TIMER button to change TIMER mode. Every time the button is pressed, display changes as follows:
 Remote controller:



Then select your desired TIMER mode (TIMER ON or TIMER OFF or TIMER ON-OFF). "ON" or "OFF" will flash.

3. Press HOUR (▲) / (▼) button to set time. It can be adjusted within 24 hours.

4. After setting correct time, press SET button to confirm "ON" or "OFF" on the remote controller stops flashing.

5. Cancel TIMER mode
 Just press TIMER button several times until TIMER mode disappears.

Hints:

After replacing batteries or a power failure happens, time setting should be reset.
 Remote controller possesses memory function, when use TIMER mode next time, just press SET button after mode selecting if time setting is the same as previous one.
 According to the Time setting sequence of TIMER ON or TIMER OFF, either Start-Stop or Stop-Start can be achieved.

EUROPEAN REGULATIONS CONFORMITY FOR THE MODELS

CE

All the products are in conformity with the following European provision:

- Low Voltage Directive 73/23/EEC
- Low Voltage Directive 2006/95/EC
- Electromagnetic Compatibility 89/336/EEC
- Electromagnetic Compatibility 2004/108/EC

ROHS

The products are fulfilled with the requirements in the directive 2002/95/EEC of the European parliament and of council on the Restriction of the use of Certain Hazardous Substances in Electrical and Electronic Equipment (EU RoHS Directive)

WEEE

In accordance with the directive 2002/96/CE of the European

parliament, herewith we inform the consumer about the disposal requirements of the electrical and electronic products.

DISPOSAL REQUIREMENTS:

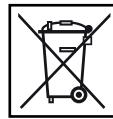

Your air conditioning product is marked with this symbol. This means that electrical and electronic products shall not be mixed with unsorted household waste. Do not try to dismantle the system yourself: the dismantling of the air conditioning system, treatment of the refrigerant, of oil and of other part must be done by a qualified installer in accordance with relevant local and national legislation. Air conditioners must be treated at a specialized treatment facility for reuse, recycling and recovery. By ensuring this product is disposed of correctly, you will help to prevent potential negative consequences for the environment and human health. Please contact the installer or local authority for more information. Battery must be removed from the remote controller and disposed of separately in accordance with relevant local and national legislation.

IMPORTANT INFORMATION REGARDING THE REFRIGERANT USED

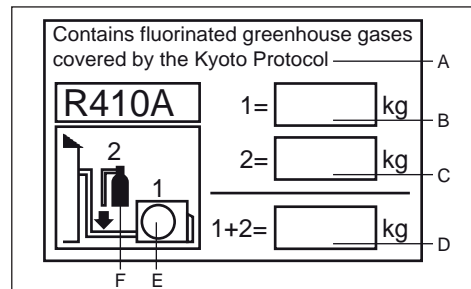

This product contains fluorinated greenhouse gases covered by the Kyoto Protocol. Do not vent into the atmosphere.

Refrigerant type: R410A

GWP* value: 1975

GWP=global warming potential

Please fill in with indelible ink,

- 1 the factory refrigerant charge of the product
- 2 the additional refrigerant amount charged in the field and
- 1+2 the total refrigerant charge

on the refrigerant charge label supplied with the product. The filled out label must be adhered in the proximity of the product charging port (e.g. onto the inside of the stop value cover).

- A contains fluorinated greenhouse gases covered by the Kyoto Protocol
- B factory refrigerant charge of the product: see unit name plate
- C additional refrigerant amount charged in the field
- D total refrigerant charge
- E outdoor unit
- F refrigerant cylinder and manifold for charging

Indoor Unit Installaion

Necessary Tools for Installation

- Driver
- Nipper
- Hacksaw
- Hole core drill
- Spanner(17,19 and 26mm)
- Gas leakage detector or soap-and-water solution
- Torque wrench (17mm,22mm,26mm)
- Pipe cutter
- Flaring tool
- Knife
- Measuring tape
- Reamer





Power Source

- Before inserting power into receptacle, check the voltage without fail.
- The power supply is the same as the corresponding nameplate.
- Install an exclusive branch circuit of the power.
- A receptacle shall be set up in a distance where the power cable can be reached. Do not extend the cable by cutting it.

Selection of Installation Place

- Place, robust not causing vibration, where the body can be supported sufficiently.
- Place, not affected by heat or steam generated in the vicinity, where inlet and outlet of the unit are not disturbed.
- Place, possible to drain easily, where piping can be connected with the outdoor unit.
- Place, where cold air can be spread in a room entirely.
- Place, nearby a power receptacle, with enough space around.
- Place where the distance of more than 1m from televisions, radios, wireless apparatuses and fluorescent lamps can be left.
- In the case of fixing the remote controller on a wall, place where the indoor unit can receive signals when the fluorescent lamps in the room are lightened.

Accessory Parts

Remote controller (1)	Drain hose (1) 
R-03 dry battery (2) 	Plastic cap (4)  Ø4X25 Screw (4) 
Mounting plate (1)	Air purifying filter(Optional) (1)

Selection of Pipe

FOR 07K 09K 12K	Liquid pipe	φ 6.35x0.8mm
	Gas pipe	φ 9.52x0.8mm

Drawing for the installation of indoor units

The models adopt HFC free refrigerant R410A

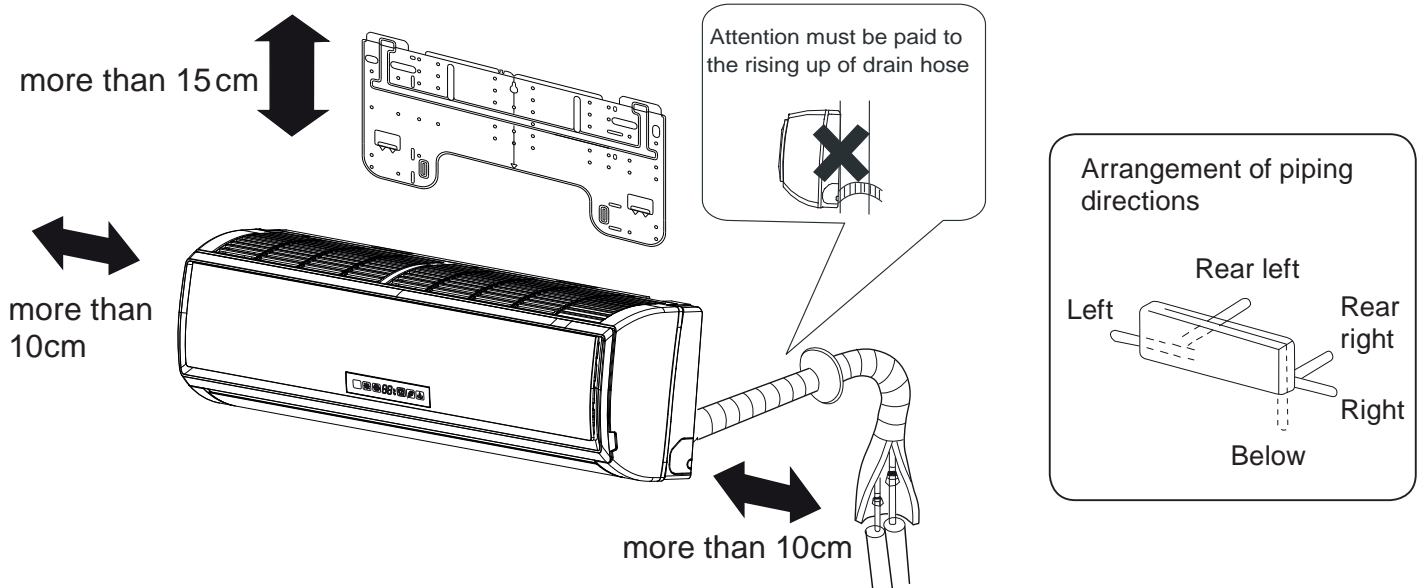

The distance between the indoor unit and the floor should be more than 2m.
Please be subject to the actual product purchased, the above picture is just for your reference.

Indoor Unit Installation

1 Fitting of the Mounting Plate and Positioning of the wall Hole

When the mounting plate is first fixed

1. Carry out, based on the neighboring pillars or lintels, a proper leveling for the plate to be fixed against the wall, then temporarily fasten the plate with one steel nail.
2. Make sure once more the proper level of the plate, by hanging a thread with a weight from the central top of the plate, then fasten securely the plate with the attachment steel nail.
3. Find the wall hole location A using a measuring tape

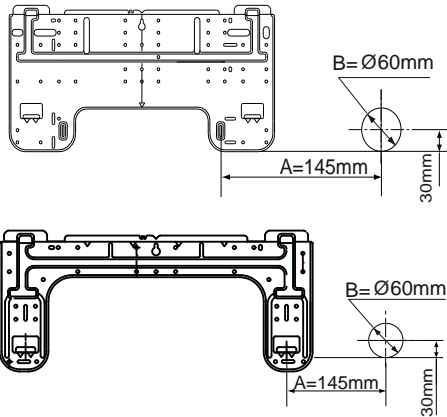

When the mounting plate is fixed side bar and lintel

- Fix to side bar and lintel a mounting bar, Which is separately sold, and then fasten the plate to the fixed mounting bar.
- Refer to the previous article, “ When the mounting plate is first fixed “, for the position of wall hole.

2 Making a Hole on the Wall and Fitting the Piping Hole Cover

- Make a hole of 60 mm in diameter, slightly descending to outside the wall.
- Install piping hole cover and seal it off with putty after installation

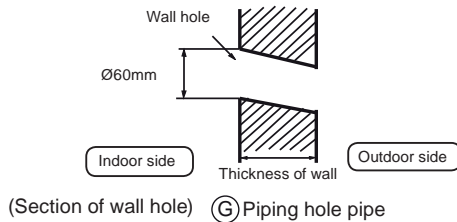

3 Installation of the Indoor Unit

Drawing of pipe

[Rear piping]

- Draw pipes and the drain hose, then fasten them with the adhesive tape

[Left · Left-rear piping]

- In case of left side piping, cut away, with a nipper, the lid for left piping.
- In case of left-rear piping, bend the pipes according to the piping direction to the mark of hole for left-rear piping which is marked on heat insulation materials.

1. Insert the drain hose into the dent of heat insulation materials of indoor unit.
2. Insert the indoor/outdoor electric cable from backside of indoor unit, and pull it out on the front side, then connect them.
3. Coat the flaring seal face with refrigerant oil and connect pipes. Cover the connection part with heat insulation materials closely, and make sure fixing with adhesive tape

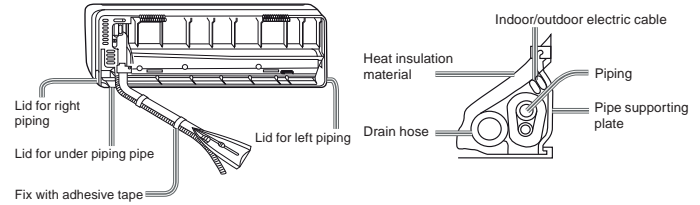

- Indoor/outdoor electric cable and drain hose must be bound with refrigerant piping by protecting tape.

[Other direction piping]

- Cut away, with a nipper, the lid for piping according to the piping direction and then bend the pipe according to the position of wall hole. When bending, be careful not to crash pipes.
- Connect beforehand the indoor/outdoor electric cable, and then pull out the connected to the heat insulation of connecting part specially.

Fixing the indoor unit body

- Hang surely the unit body onto the upper notches of the mounting plate. Move the body from side to side to verify its secure fixing.
- In order to fix the body onto the mounting plate, hold up the body aslant from the underside and then put it down perpendicularly.

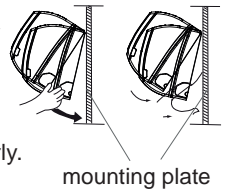

Unloading of indoor unit body

- When you unload the indoor unit, please use your hand to arise the body to leave a agraffe, then lift the bottom of the body outward slightly and lift the unit aslant until it leaves the mounting plate.

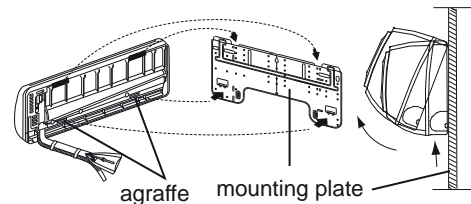

4 Connecting the indoor/outdoor Electric Cable

Removing the wiring cover

- Remove terminal cover at right bottom corner of indoor unit, then take off wiring cover by removing its screws.

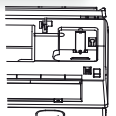

When connecting the cable after installing the indoor unit

1. Insert from outside the room cable into left side of the wall hole, in which the pipe has already existed.
2. Pull out the cable on the front side, and connect the cable making a loop.

When connecting the cable before installing the indoor unit

- Insert the cable from the back side of the unit, then pull it out on the front side.
- Loosen the screws and insert the cable ends fully into terminal block, then tighten the screws.
- Pull the cable slightly to make sure the cables have been properly inserted and tightened.
- After the cable connection, never fail to fasten the connected cable with the wiring cover.

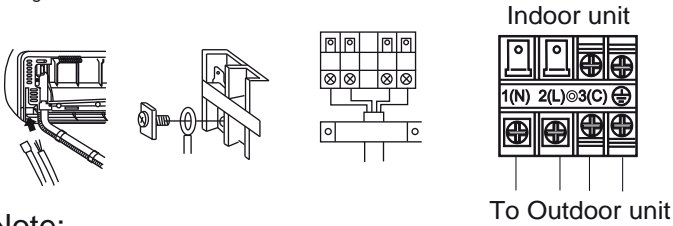

Note:

When connecting the cable, confirm the terminal number of indoor and outdoor units carefully. If wiring is not correct, proper operation can not be carried out and will cause defect.

Model	AS07GS1ERA AS09GS1ERA AS12GS1ERA
Connecting wiring	≥ 4G0.75mm ²

1. If the supply cord is damaged, it must be replaced by the manufacturer or its service agent or a similar qualified person. The type of connecting wire is H05RN-F or H07RN-F.
2. If the fuse on PC board is broken please change it with the type of T.3.15A/250VAC (Indoor).
3. The wiring method should be in line with the local wiring standard.
4. After installation, the power plug should be easily reached.
5. A breaker should be incorporated into fixed wiring. The breaker should be all-pole switch and the distance between its two contacts should be not less than 3mm.

5 Power Source Installation

- The power source must be exclusively used for air conditioner.
- In the case of installing an air conditioner in a moist place, please install an earth leakage breaker.
- For installation in other places, use a circuit breaker as far as possible.

6 Cutting and Flaring Work of Piping

- Pipe cutting is carried out with a pipe cutter and burs must be removed.
- After inserting the flare nut, flaring work is carried out.

	Flare tool for R410A	Conventional flare tool	
	Clutch-type	clutch-type(Rigid-type)	Wing-nut type (Imperial-type)
A	0~0.5mm	1.0~1.5mm	1.5~2.0mm

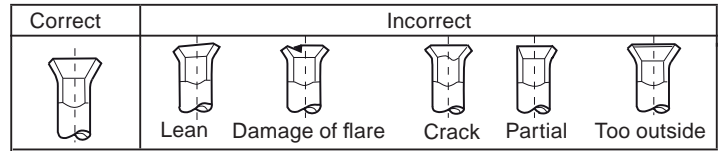
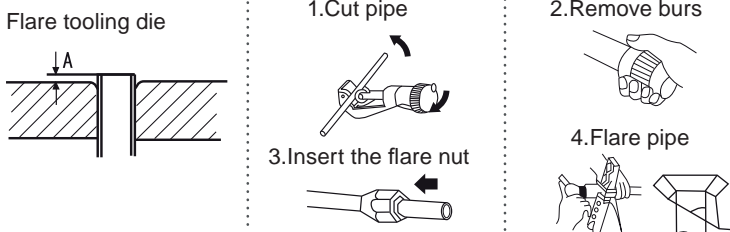

7 On Drainage

- Please install the drain hose so as to be downward slope without fail.
- Please don't do the drainage as shown below.

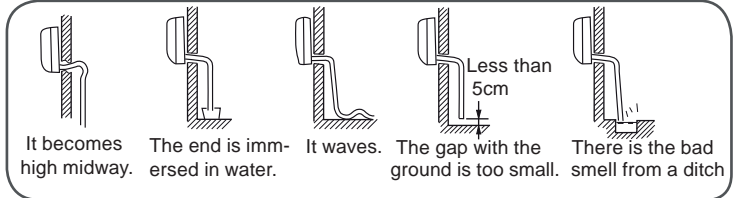

- Please pour water in the drain pan of the indoor unit, and confirm that drainage is carried out surely to outdoor.
- In case that the attached drain hose is in a room, please apply heat insulation to it without fail.

8 On Drainage

Code indication	Trouble description	Analyze and diagnose
E1	Indoor fan motor malfunction	Faulty connector connection;
E2	Heat-exchange sensor failure	Faulty thermistor;
E4	Indoor EEPROM error	Faulty EEPROM;
E7	Communication fault between indoor and outdoor units	Faulty PCB;
E14	Indoor fan motor malfunction	Indoor unit- outdoor unit signal transmission error due to wiring error;
		Faulty PCB;
		Operation halt due to breaking of wire inside the fan motor;
		Operation halt due to breaking of the fan motor lead wires;
		Detection error due to faulty indoor unit PCB;

9 Check for Installation and Test Run

- Please kindly explain to our customers how to operate through the instruction manual.







Check Items for Test Run

Put check mark ✓ in boxes

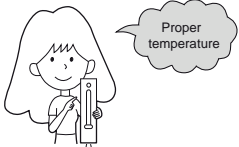
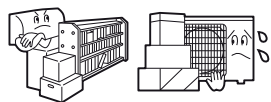

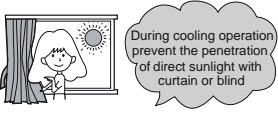
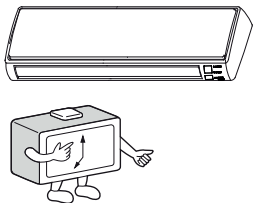
- Gas leak from pipe connecting?
- Heat insulation of pipe connecting?
- Are the connecting wirings of indoor and outdoor firmly inserted to the terminal block?
- Is the connecting wiring of indoor and outdoor firmly fixed?
- Is drainage securely carried out?
- Is the earth line securely connected?
- Is the indoor unit securely fixed?
- Is power source voltage abided by the code?
- Is there any noise?
- Is the lamp normally lighting?
- Are cooling and heating (when in heat pump) performed normally?
- Is the operation of room temperature regulator normal?

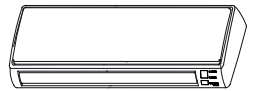
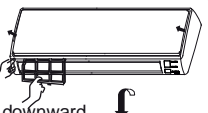
Maintenance

For Smart Use of The Air Conditioner

<p>Setting of proper room temperature</p> 	<p>Do not block the air inlet or outlet</p> 	<p>Remote Controller</p>  <p>Do not use water, wipe the controller with a dry cloth. Do not use glass cleaner or chemical cloth.</p>	<p>Indoor Body</p>  <p>wipe the air conditioner by using a soft and dry cloth. For serious stains, use a neutral detergent diluted with water. Wring the water out of the cloth before wiping, then wipe off the detergent completely.</p>
<p>Close doors and windows during operation</p> 	<p>Use the timer effectively</p> 	<p>Do not use the following for cleaning</p>  <p>Gasoline, benzene, thinner or cleanser may damage the coating of the unit. Hot water over 40°C (104°F) may cause discoloring or deformation.</p>	
<p>If the unit is not to be used for a long time, turn off the power supply main switch.</p> 	<p>Use the louvers effectively</p> 	<p>Air Filter cleaning</p> <ol style="list-style-type: none"> 1 Open the inlet grille by pulling it upward. 2 Remove the filter. Push up the filter's center tab slightly until it is released from the stopper, and remove the filter downward. 3 Clean the filter. Use a vacuum cleaner to remove dust, or wash the filter with water. After washing, dry the filter completely in the shade. 4 Attach the filter. Attach the filter correctly so that the "FRONT" indication is facing to the front. Make sure that the filter is completely fixed behind the stopper. If the right and left filters are not attached correctly, that may cause defects. 5 Close the inlet grille.  	

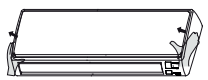
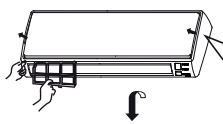
Replacement of Air Purifying Filter

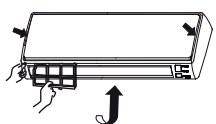









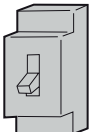
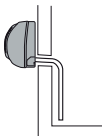

<ol style="list-style-type: none"> 1. Open the Inlet Grille Prop up the inlet grille by using a small device named grille-support which located in the right side of the indoor unit. 2. Detach the standard air filter Slide the knob slightly upward to release the filter, then withdraw it. 3. Attach Air Purifying Filter Put air purifying filter appliances into the right and left filter frames.   	<ol style="list-style-type: none"> 4. Attach the standard air filter (Necessary installation) 5. Close the Inlet Grille Close the Grille surely <p>ATTENTION:</p> <p>The white side of the photocatalyst air purifying filter face outside, and the black side face the unit. The green side of the bacteria-killing medium air purifying filter face outside, and the white side face the unit.</p> <p>NOTE:</p> <ul style="list-style-type: none"> • The photocatalyst air purifying filter will be solarized in fixed time. In normal family, it will be solarized every 6 months. • The bacteria-killing medium air purifying filter will be used for a long time, no need for replacement. But in the period of using them, you should remove the dust frequently by using vacuum cleaner or flapping them lightly, otherwise, its performance will be affected. • Please keep the bacteria-killing medium air purifying filter in the cool and dry conditions avoid long time directly sunshine when you stop using it, or its ability of sterilization will be reduced. 
--	---

Cautions

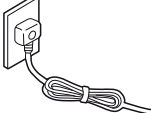
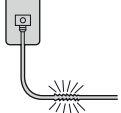





⚠ WARNING

Please call Sales/Service Shop for the Installation.
Do not attempt to install the air conditioner by yourself because improper works may cause electric shock, fire, water leakage.

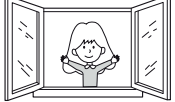
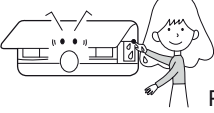
⚠ WARNING

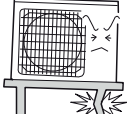



<p>When abnormality such as burnt-smell found, immediately stop the operation button and contact sales shop.</p>  <p>OFF</p>  <p>STRICT ENFORCEMENT</p>	<p>Use an exclusive power source with a circuit breaker</p> 	<p>Check proper installation of the drainage securely</p>  <p>STRICT ENFORCEMENT</p>
<p>Connect power supply cord to the outlet completely</p>  <p>STRICT ENFORCEMENT</p>	<p>Use the proper voltage</p>  <p>STRICT ENFORCEMENT</p>	<p>1. Do not use power supply cord extended or connected in halfway 2. Do not install in the place where there is any possibility of inflammable gas leakage around the unit. 3. Do not get the unit exposed to vapor or oil steam.</p>  <p>PROHIBITION</p>
<p>Do not use power supply cord in a bundle.</p>  <p>PROHIBITION</p>	<p>Take care not to damage the power supply cord.</p>  <p>PROHIBITION</p>	<p>Do not insert objects into the air inlet or outlet.</p>  <p>PROHIBITION</p>
<p>Do not start or stop the operation by disconnecting the power supply cord and so on.</p>  <p>PROHIBITION</p>	<p>Do not channel the air flow directly at people, especially at infants or the aged.</p>  <p>PROHIBITION</p>	<p>Do not try to repair or reconstruct by yourself.</p> 
		<p>Connect the earth cable.</p>  <p>earthing</p>

⚠ CAUTION

<p>Do not use for the purpose of storage of food, art work, precise equipment, breeding, or cultivation.</p>  <p>PROHIBITION</p>	<p>Take fresh air occasionally especially when gas appliance is running at the same time.</p>  <p>STRICT ENFORCEMENT</p>	<p>Do not operate the switch with wet hand.</p>  <p>PROHIBITION</p>
<p>Do not install the unit near a fireplace or other heating apparatus.</p>  <p>PROHIBITION</p>	<p>Check good condition of the installation stand</p>  <p>PROHIBITION</p>	<p>Do not pour water onto the unit for cleaning</p>  <p>PROHIBITION</p>
<p>Do not place animals or plants in the direct path of the air flow</p>  <p>PROHIBITION</p>	<p>Do not place any objects on or climb on the unit.</p>  <p>PROHIBITION</p>	<p>Do not place flower vase or water containers on the top of the unit.</p>  <p>PROHIBITION</p>

Trouble shooting

Before asking for service, check the following first.

	Phenomenon	Cause or check points
Normal Performance inspection	The system does not restart immediately. 	<ul style="list-style-type: none"> When unit is stopped, it won't restart immediately until 3 minutes have elapsed to protect the system. When the electric plug is pulled out and reinserted, the protection circuit will work for 3 minutes to protect the air conditioner.
	Noise is heard 	<ul style="list-style-type: none"> During unit operation or at stop, a swishing or gurgling noise may be heard. At first 2-3 minutes after unit start, this noise is more noticeable. (This noise is generated by refrigerant flowing in the system.) During unit operation, a cracking noise may be heard. This noise is generated by the casing expanding or shrinking because of temperature changes. Should there be a big noise from air flow in unit operation, air filter may be too dirty.
	Smells are generated.	<ul style="list-style-type: none"> This is because the system circulates smells from the interior air such as the smell of furniture, paint, cigarettes.
	Mist or steam are blown out. 	<ul style="list-style-type: none"> During COOL or DRY operation, indoor unit may blow out mist. This is due to the sudden cooling of indoor air.
	In dry mode, fan speed can't be changed.	<ul style="list-style-type: none"> In DRY mode, when room temperature becomes lower than temp. setting+2 °C, unit will run intermittently at LOW speed regardless of FAN setting.
Multiple check		<ul style="list-style-type: none"> Is power plug inserted? Is there a power failure? Is fuse blownout?
	Poor cooling 	<ul style="list-style-type: none"> Is the air filter dirty? Normally it should be cleaned every 15 days. Are there any obstacles before inlet and outlet? Is temperature set correctly? Are there some doors or windows left open? Is there any direct sunlight through the window during the cooling operation? (Use curtain) Are there too much heat sources or too many people in the room during cooling operation?

Cautions

- Do not obstruct or cover the ventilation grille of the air conditioner. Do not put fingers or any other things into the inlet/outlet and swing louver.
- Do not allow children to play with the air conditioner. In no case should children be allowed to sit on the outdoor unit.

Specifications

- The refrigerating circuit is leak-proof.

The machine is adaptive in following situation

1. Applicable ambient temperature range:

Cooling	Indoor	Maximum:D.B/W.B 32°C/23°C Minimum:D.B/W.B 21°C/15°C
	Outdoor	Maximum:D.B/W.B 46°C/26°C Minimum: D.B 18°C
Heating	Indoor	Maximum:D.B 27°C Minimum: D.B 15°C
	Outdoor	Maximum:D.B/W.B 24°C/18°C Minimum:D.B/W.B -7°C/-8°C
	Outdoor (INVERTER)	Maximum:D.B/W.B 24°C/18°C Minimum:D.B -15°C

- If the power supply cord is damaged, it must be replaced by the manufacturer or its service agent or a similar qualified person.
- If the fuse of indoor unit on PC board is broken, please change it with the type of T. 3.15A/ 250V. If the fuse of outdoor unit is broken, change it with the type of T.25A/250V
- The wiring method should be in line with the local wiring standard.
- After installation, the power plug should be easily reached.
- The waste battery should be disposed properly.
- The appliance is not intended for use by young children or infirm persons without supervision.
- Young children should be supervised to ensure that they do not play with the appliance.
- Please employ the proper power plug, which fit into the power supply cord.
- The power plug and connecting cable must have acquired the local attestation.
- In order to protect the units, please turn off the A/C first, and at least 30 seconds later, cutting off the power.

