

OPERATING MANUAL

WEB MONITORING TOOL for VRF System

UTY-AMGX

Ver. 1.2



CAUTION

Please read the LICENSE AGREEMENT in the manual first.

9708314013-04

FUJITSU GENERAL LIMITED

LICENSE AGREEMENT for "WEB MONITORING TOOL for VRF SYSTEM" (Version 1.2)

IMPORTANT-READ CAREFULLY

This "WEB MONITORING TOOL for VRF SYSTEM" License Agreement (LICENSE AGREEMENT) is a legal agreement between you and Fujitsu General Limited (FGL) for the use of VRF WEB MONITORING TOOL products designated below, which includes computer software and printed materials, and may include online or electronic documentation (SOFTWARE PRODUCT or SOFTWARE). By installing, copying, or otherwise using the SOFTWARE PRODUCT, you accept to be bound by all of the terms and conditions of this LICENSE AGREEMENT. If you do not agree to all of the terms and conditions of this LICENSE AGREEMENT, you may not use the SOFTWARE PRODUCT and shall promptly return the SOFTWARE PRODUCT to the place from which you have obtained it.

1. SOFTWARE PRODUCT LICENSE.

The SOFTWARE PRODUCT is protected by copyright laws and international copyright treaties, as well as by other intellectual property laws and treaties. The SOFTWARE PRODUCT is licensed to you, not sold. FGL owns the title, copyright, and other intellectual property rights in the SOFTWARE PRODUCT.

2. GRANT OF LICENSE.

FGL hereby grants you the limited, non-exclusive and non-transferable rights only for the purpose of controlling the VRF air-conditioning system products (VRF) provided you comply with all terms and conditions of this LICENSE AGREEMENT.

3. COPYRIGHT.

All right, title, and copyright in and to the SOFTWARE PRODUCT, and any copies of the SOFTWARE PRODUCT are owned by FGL. The SOFTWARE PRODUCT is protected by copyright laws and international treaty provisions. Therefore, you may copy the SOFTWARE PRODUCT solely for backup or archival purposes.

4. DESCRIPTION OF OTHER RIGHTS AND LIMITATIONS.

(1) LIMITATIONS ON REVERSE ENGINEERING, DECOMPILATION, AND DISASSEMBLY.

You may not reverse engineer, decompile, or disassemble the SOFTWARE PRODUCT, except and only to the extent that applicable law expressly permits such activity notwithstanding this limitation.

(2) RENTAL.

You may not rent or lease the SOFTWARE PRODUCT.

(3) SOFTWARE TRANSFER.

You may not transfer the SOFTWARE PRODUCT to any person and/or entity (-ies) either payable or free of charge.

(4) TERMINATION.

Without prejudice to any other rights, FGL may terminate this LICENSE AGREEMENT if you fail to comply with the terms and conditions of this LICENSE AGREEMENT. In such an event, you shall promptly return all originals and copies of the SOFTWARE PRODUCT to FGL.

5. USE OF SOFTWARE PRODUCT.

You may install and use the enclosed SOFTWARE PRODUCT on a single terminal connected to a single computer. You may not network the SOFTWARE or otherwise use it on more than one computer terminal at the same time. The infrastructure necessary to use this software (PC, accessories, etc.), shall be prepared separately by you.

6. NO WARRANTY.

TO THE MAXIMUM EXTENT PERMITTED BY APPLICABLE LAW, FGL EXPRESSLY DISCLAIMS ANY WARRANTY FOR THE SOFTWARE PRODUCT. THE SOFTWARE PRODUCT AND ANY RELATED DOCUMENTATION IS PROVIDED "AS IS" WITHOUT WARRANTY OF ANY KIND, EITHER EXPRESSED OR IMPLIED, INCLUDING, WITHOUT LIMITATION, THE IMPLIED WARRANTIES OR MERCHANTABILITY OF FITNESS FOR A PARTICULAR PURPOSE. THE ENTIRE RISK ARISING OUT OF USE OR PERFORMANCE OF THE SOFTWARE PRODUCT REMAINS WITH YOU.

7. LIMITATION OF LIABILITY AND CUSTOMER REMEDIES.

FGL'S ENTIRE LIABILITY AND YOUR EXCLUSIVE REMEDY UNDER THIS LICENSE AGREEMENT SHALL BE, AT FGL'S OPTION, REPLACEMENT OF THE SOFTWARE WHICH IS RETURNED TO FGL. THIS LICENSE AGREEMENT SHALL ALSO APPLY TO THE REPLACEMENT SOFTWARE SUPPLIED UNDER THIS SECTION 7.

8. NO LIABILITY FOR CONSEQUENTIAL DAMAGES.

TO THE MAXIMUM EXTENT PERMITTED BY APPLICABLE LAW, IN NO EVENT SHALL FGL BE LIABLE FOR ANY DAMAGES WHATSOEVER (INCLUDING, WITHOUT LIMITATION, DAMAGES FOR LOSS OF BUSINESS PROFIT, BUSINESS INTERRUPTION, LOSS OF BUSINESS INFORMATION, OR ANY OTHER PECUNIARY LOSS) DIRECT OR INDIRECT, TO YOU OR TO ANY THIRD PARTY, ARISING OUT OF THE USE OR INABILITY TO USE THIS PRODUCT, EVEN IF FGL HAS BEEN ADVISED OF THE POSSIBILITY OF SUCH DAMAGES.

9. ENTIRE AGREEMENT.

This LICENSE AGREEMENT (including any addendum or amendment to this LICENSE AGREEMENT included with the SOFTWARE PRODUCT) is the entire agreement between you and FGL relating to the SOFTWARE PRODUCT and supersedes all prior contemporaneous oral or written communications, proposals and representations with respect to the SOFTWARE PRODUCT or any other subject covered by this LICENSE AGREEMENT.

10. INDEMNITY.

You agree to indemnify and hold FGL, and its subsidiaries, affiliates, officers, agents, co-branders or other partners, and employees, harmless from any damage, claim or demand, including without limitation reasonable attorneys' fees, made by any third party due to or arising out of your violation of the terms and conditions of this LICENSE AGREEMENT, or your violation of any rights of another person or entity.

11. GOVERNING LAW AND JURISDICTION.

To the maximum extent permitted by applicable law, this LICENSE AGREEMENT is governed by the laws of JAPAN. To the maximum extent permitted by applicable law, you and FGL hereby irrevocably submit to the exclusive jurisdiction of the Tokyo District Court and other higher courts having jurisdiction in Japan for the settlement of disputes arising under or in connection with this LICENSE AGREEMENT.

Contents

1. Safety precautions	6
1-1 Safety precautions.....	6
1-2 Precautions when using the Web Monitoring Tool.....	7
2. Outline	8
3. Data acquisition application starting flow	10
3-1 Screen transition.....	10
3-2 Data acquisition application starting (at initial starting).....	11
3-2-1 User registration	11
3-2-2 Login	12
3-2-3 Site data selection.....	13
3-2-4 Name master database file selection screen	14
3-2-5 Scanning.....	17
3-2-6 Mismatched unit list	21
3-3 Data acquisition application starting (automatic starting) ..	22
4. Data acquisition application right click menu	23
4-1 Outline.....	23
4-1-1 Menu	23
4-1-2 Screen transition (online)	24
4-2 Web browser starting (menu screen).....	25
4-3 Environment setting	26
4-3-1 Display setting.....	26
4-3-2 Transmission mode setting	28
4-3-3 Error notification e-mail setting	29
4-3-4 Mail Transmission Authentication Setting	30
4-3-5 Room temperature display setting	32
4-4 Re-scanning	33
4-5 System Setting	33
4-5-1 Network Topology Analyzer.....	33



4-5-2 Remote Setting	35
4-5-3 System Time Setting	36
4-5-4 Manual Setting	39
4-5-5 Central Release	41
4-6 Exiting	43
5. WEB application	44
<hr/>	
5-1 Screen transition	44
5-1-1 Web application starting conditions and functions change	44
5-1-2 Screen transition	46
5-2 Menu	48
5-3 Login screen	49
5-4 Main menu	50
5-5 System list screen	51
5-5-1 Name and function of each area	51
5-5-2 System list display	54
5-5-3 System list printing	55
5-6 Detail screen (Diagram)	58
5-6-1 Name and function of each area	58
5-6-2 Schematic specification method	69
5-7 Detail screen (Status List)	70
5-7-1 Name and function of each area	71
5-8 Commissioning tool	74
5-8-1 Name and function of each area	74
5-8-2 Operating procedure	77
5-8-3 Commissioning report generation	80
5-9 Operation history screen	82
5-9-1 Name and function of each area	82
5-9-2 Operation history specification	88
5-9-3 Operation history printing	89

5-10	Error history screen	92
5-10-1	Name and function of each area.....	92
5-10-2	Error history display method.....	93
5-10-3	Error history printing.....	95
5-10-4	Unit Memory.....	97
5-10-5	Request Error History.....	99
5-11	Control screen	100
5-12	Others screen	102
5-13	Others screen (Setting)	103
5-13-1	User registration.....	104
5-13-2	User change.....	105
5-13-3	User deletion.....	106
5-13-4	Demand interval setup.....	107
5-14	Others screen (Download)	108
5-14-1	Name and function of each area.....	109
5-14-2	Procedures for Creating Download Files.....	110
5-14-3	Data file download/deletion.....	111
5-15	Others screen (Display setting)	112
5-16	Others screen (Time Guard Information)	113
5-16-1	Time Guard Information.....	113
5-17	Troubleshooting screen	114
5-17-1	Name and functions of each area.....	114
5-18	Log out	115
5-19	When error generated	116
5-19-1	Scanning other units.....	116
5-19-2	Data acquisition application shutdown.....	116
6.	Troubleshooting	117

1. Safety precautions

1-1 Safety precautions

- Before using Web Monitoring Tool, read this “Safety precautions” thoroughly to ensure the correct operation.
- This section describes the important safety information to operate Web Monitoring Tool.
- The meanings of “WARNING” and “CAUTION” are explained as follows.

 WARNING	This mark indicates the procedures, which might result in the death of or serious injury to the user or service personnel if improperly performed.
 CAUTION	This mark indicates the procedures, which might result in personal harm to the user or damage to property if improperly performed.

This manual is for service personnel authorized to use the Web Monitoring Tool. Always keep this manual in an easily accessible place for use by authorized service personnel.

 WARNING
1. When using U10 USB Network Interface, follow the instructions given in the manual that comes with product.

 CAUTION
Web Monitoring Tool can control the air-conditioner system on a personal computer. Be careful not to turn off the power supply of the personal computer, or not to finish the application compulsorily during operation. Otherwise, Web Monitoring Tool might malfunction. For personal computer used as Web Monitoring Tool, refer to the instruction manual.

1-2 Precautions when using the Web Monitoring Tool

1. Please read and fully understand the Operating Manual. Fujitsu General Limited is not responsible for improper use.
2. Fujitsu General Limited is not responsible if the settings in this software or data used for the controlling are deleted. We request that the customer take responsibility for the administration of the settings and control data.
3. If the personal computer operating this software stops, immediately restart the computer and restart this software. Also, if the unit equipment stops due to a power supply interruption, restart this software immediately as there is the potential for malfunctioning.
4. The master CD for this software and the WIBU-key (Software protection key) will not be reissued. Store the master CD in a safe place after installing.
5. For information about operating your personal computer, refer to the operating manual for the PC and the store that sold it.
6. Never start this software simultaneously with other software as this may cause malfunctioning. The PC running this software must be dedicated for the use of this product.
7. When Web Monitoring Tool program is running, do not set/adjust the time and date of the PC to prevent data becoming inconsistent.
If time has been adjusted backward toward the past, wait for the time to elapse until the adjusted time catches up with the original time before adjustment. You may then start the Web Monitoring Tool, again.
8. Web Monitoring Tool is tested to install and operate under new Windows environment.
9. When program executional environment of Windows is corrupted or abnormal, or other softwares that interfere with the operation of Web Monitoring Tool is installed or running, Web Monitoring Tool may not install or run properly. It is usually extremely difficult to detect such conditions, if it occurs.
10. Web Monitoring Tool product is provided with softwares, drivers, components listed below.
11. If the same kind of softwares, drivers, components with different version is installed on the same PC, Web Monitoring Tool may not install or run properly.
 - 1) .NET Framework
 - 2) Internet Information Services (IIS)
 - 3) Microsoft Data Access Components (MDAC)
 - 4) Microsoft SQL Server 2005 Express
12. When using the web monitoring tool, do not use other than Internet Explorer display magnification 100%.
If other than 100% is used, normal display may be impossible.

2. Outline

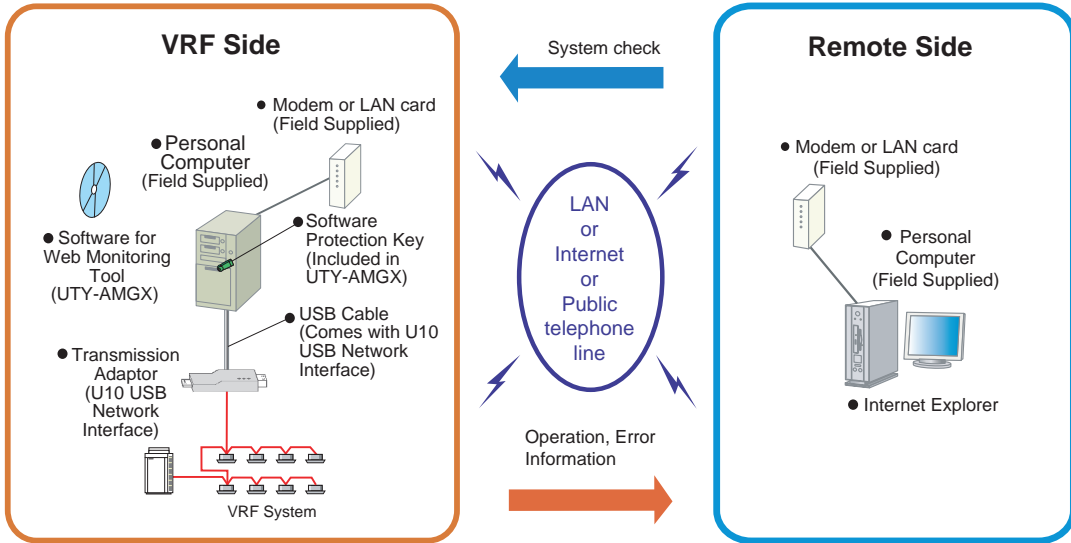

This operating manual explains the operating procedures for the software of Web Monitoring Tools for the VRF control system.

This tool lets you check a VRF System installed at a distant place from the remote side by LAN, internet, public telephone line, and other communications method. If a personal computer connectable to the network and Internet Explorer are available at the remote side, VRF System checks can be carried out at the same level as the Service Tool by simply selecting the time and place.

When an error occurs in the VRF System, the error is displayed at the remote side monitor. If internet is selected as the communications method, the error can be reported to a pre-registered address by e-mail. Moreover, since unit data for up to the last past week is recorded at the VRF side, defect phenomena for on-site repair can be grasped in advance by checking the unit data from a remote place when a defect occurred.

■ Software construction

The Web Monitoring Tool software consists of the two applications **Data acquisition application** and **WEB application**.

The **Data acquisition application** is a program which resides and run in a background when the Web Monitoring Tool is started, and exchanges data with the VRF System transmission line. It also records the received unit data to a database.



The **WEB application** is a Web server and a collection of server side program and scripts which converts the acquired Unit data to Table and Graph, and displays them to a browser (Internet Explorer) upon request from remote side. It also converts operations input from the User and passes them to the Data acquisition application through the Database. In this manual, Web application will refer to the collection of server side program and scripts.

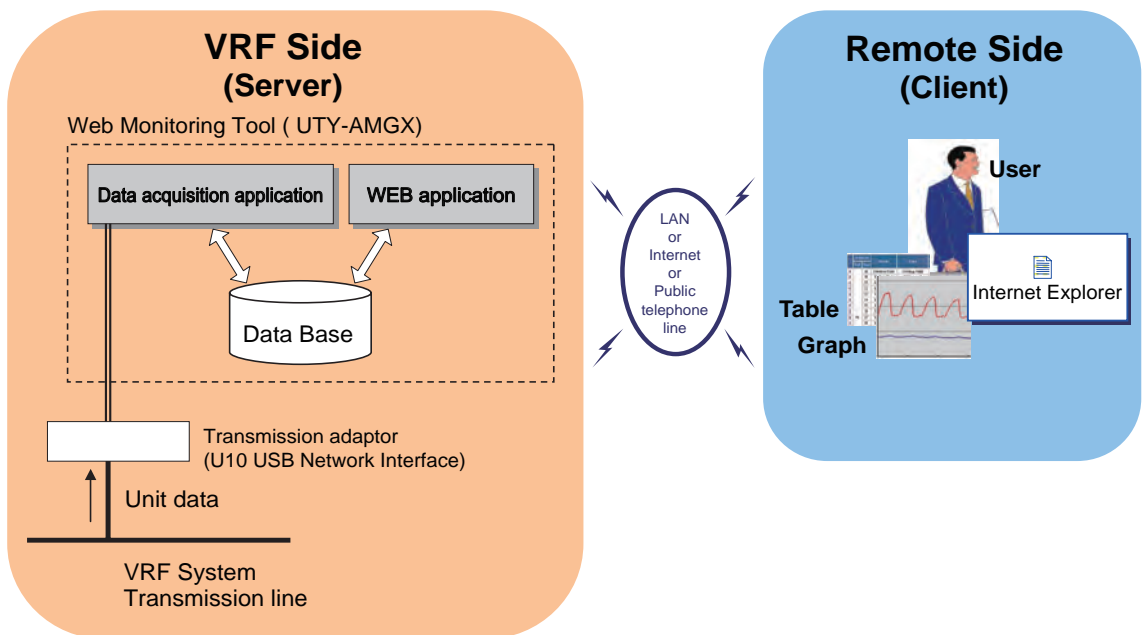

- Hereinafter, the following will be used in the descriptions in this operating manual:

VRF Side → Server
 Remote Side → Client

3. Data acquisition application starting flow

3-1 Screen transition

By default, Data acquisition application of Web Monitoring Tool will start automatically upon power up of PC. Data acquisition application may be accessed by a right click menu of an icon in a task tray. The application may be terminated from this right click menu also. Refer Section 3.3 and 4 for detail.

User Registration



Opening



Online site data selection

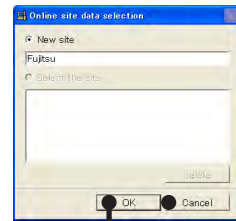

Login



Name master database

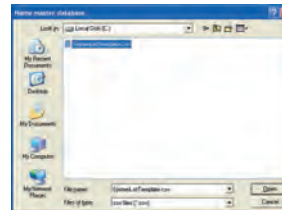

Scanning setting

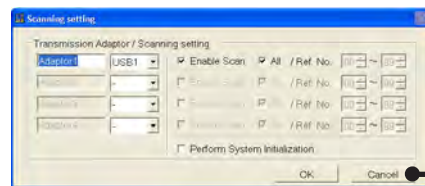

Task tray resident



Mismatched Unit List

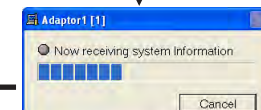
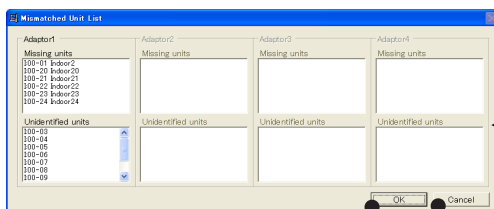

3. Data acquisition application starting flow

3-2 Data acquisition application starting (at initial starting)

3-2-1 User registration

User registration, change, and deletion can also be performed at 5-13 Others screen (Setting). The use of this software is restricted to authorized person. User ID and password is used for authentication. When you start this software for the first time, you will be prompted to register User ID, Password, and Level of the User using this screen.

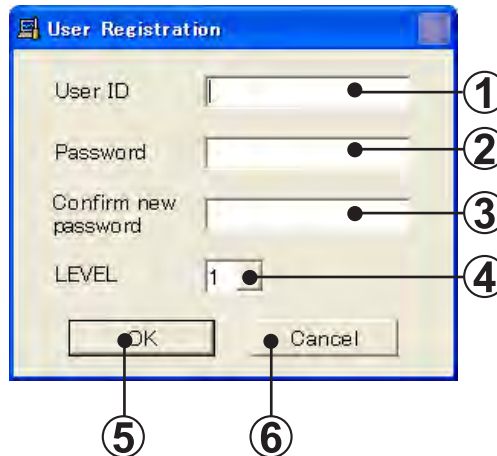

- ① User ID input field
Input the user ID. (Up to 20 alphanumeric characters) (*1)
- ② Password input field
Input the password. (Up to 20 alphanumeric characters) (*1)
- ③ Password confirmation input field
Input the password again for confirmation. (Up to 20 alphanumeric characters) (*2)

- ④ User level selection
Sets user level. Depending on the user level, function that may be performed varies. For details, refer to section 5-1-1 “Web application starting conditions and function change.”



- ⑤ OK button
When the button is clicked, the inputted data is saved.
The opening screen is displayed, and operation advances to site data selection processing.
- ⑥ Cancel button
When the button is clicked, user registration stops and the Web Monitoring Tool ends.

Note *1 When the user ID and password input fields are not inputted, an error message is displayed.

*2 When the password and password confirmation input contents are different, an error message is displayed.

3-2-2 Login

When user registration is completed, the login screen is displayed.

Login by registered user. The login screen is also displayed when security is necessary for certain actions.

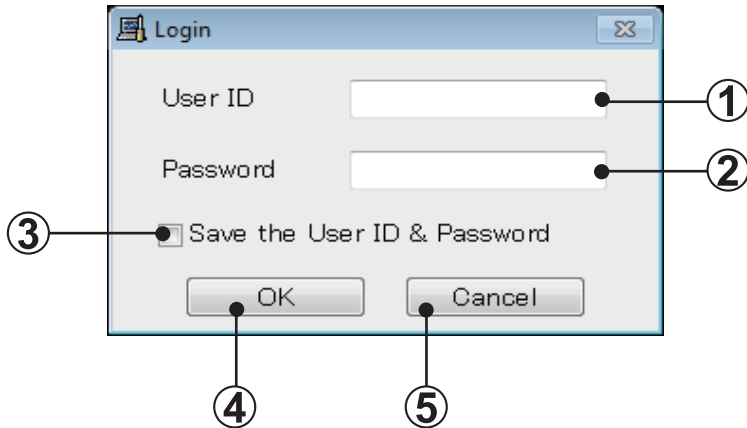

1 User ID input field
Input the ID of the user to be logged in. (Up to 20 alphanumeric characters) (*1)

2 Password input field
Input the password of the user to be logged in. (Up to 20 alphanumeric characters) (*1)

3 Save the User ID & password check box
When the Save the User ID & password check box was checked, the same user ID and password are automatically displayed the next time the Web Monitoring Tool is started.

When the Save the User ID & password check box is not checked, the next time the Web Monitoring Tool is started, the user ID and password are not displayed and must be manually inputted.

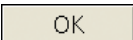
4 OK button
When the  button is clicked, the opening screen of the Web Monitoring Tool is displayed, and then operation advances to site data selection processing.



5 Cancel button
When the  button is clicked, the Web Monitoring Tool ends.

Note *1 When the user ID and password input fields are not inputted, an error message is displayed.

3-2-3 Site data selection

This screen is displayed when registering a new site at initial starting. Only 1 site managed by Web Monitoring Tool can be registered.

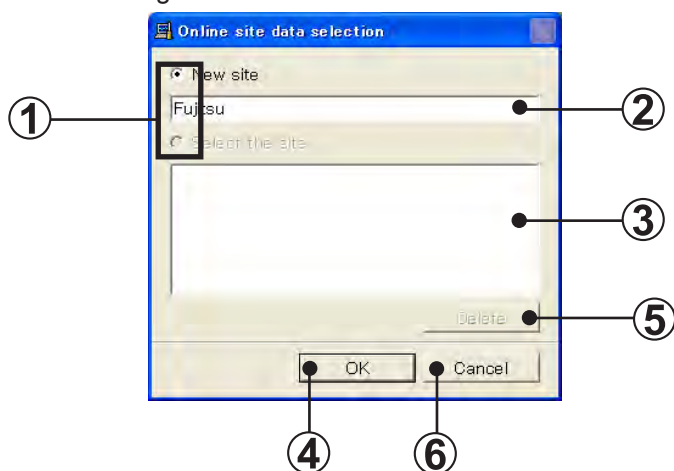

- ①** Site data selection item
To register a new site, select “New site”. To select an already registered site data, select “Select the site”.
- ②** New site name input field
When “New site” was selected at step ①, input the site name to be registered. Only alphanumeric characters and spaces may be used for the site name. (Up to 20 alphanumeric characters and spaces) (*1)
- ③** Site data selection display field
Displays the site names already registered.
When “Select the site” was selected at step ①, select the objective site name. (*2)
- ④** OK button
When the button is clicked, the name master database file selection screen is displayed.
- ⑤** Delete button
Can be used only when the objective site name was selected at step ③.
When the button is clicked, all the data of the selected site is deleted.
Before deletion processing, a confirmation screen is displayed.
- ⑥** Cancel button
When the button is clicked, the program returns to the login screen.

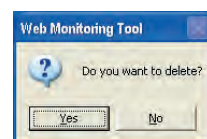

Note *1 When deleting site data, execute the following batch file.
C:\Program Files\VRF System\Web Monitoring Tool\Deletesite.bat
This batch file exist in the Web Monitoring Tool software installation directory. The above directory shows the case where the software installation was performed using the default installation directory. When this batch file is executed, all the site data, including past unit data, is deleted and the site selection screen can be displayed the next time the Web Monitoring Tool is started. It is strongly recommended that you save the data for the current site before deletion.

*2 When a site is not selected, an error message is displayed.

3-2-4 Name master database file selection screen

When scanning is performed by specifying a name master database file (.CSV), the specified file and the unit data actually scanned are collated, and the mismatched unit list of par. 3-2-6 can be performed.

Create the name master database file in advance and specify it from this screen.

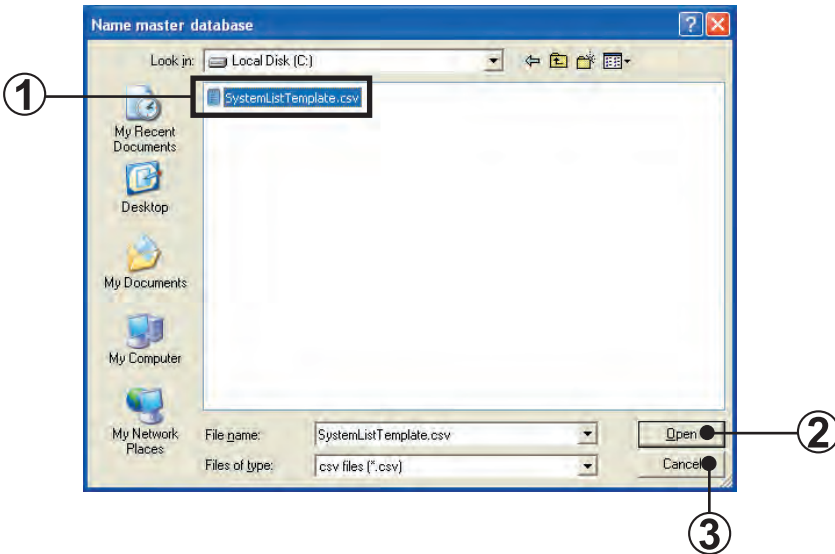

- ①** CSV file selection
Select a name master database file (.CSV) containing the unit data. (*1)
- ②** Open button
When the button is clicked, the scanning setting screen is displayed, and after the end of scanning, the differences between the name master database file and actual scanning result can be confirmed.
- ③** Cancel button
When scanning is performed without selecting a name master database file (.CSV), click the button. (The scanning setting screen is displayed.) In this case, the mismatched unit list screen is not displayed after scanning. (*2)

Note *1 Files other than CSV files cannot be selected and displayed.
*2 When not selected, an error is not displayed even if there are units which cannot receive the address information normally.

■ Name master database file (.CSV) preparation

The address, name, and other information which becomes the comparison source during scanning are saved beforehand in CSV format.

- ① Since the template [SystemListTemplate.xls] is C:\Program Files\VRF System\Web Monitoring Tool\, open that file with Excel. (*1) (*2)
- ② Since the following screen is displayed, set a value at each item.

Adaptor No.	Refrigerant	Unit		Name	Model Name
Input Transmission Adaptor number No. 1-4	Input Refrigerant Address. 0-99	Input "Model" numerically. Inner: 1, Outer: 2	Input Unit Address. Outer: 0-3, Inner: 0-63	Input unit name Max 20 characters:(bytes)	Input Model name Max 20 characters:(bytes)
1	0	2	0	OutDoor1	AJYA72LALH
1	0	2	1	OutDoor2	AJY108LALH
1	0	2	2	OutDoor3	AJY126LALH
1	0	1	0	Indoor1	AUXB07LALH
1	0	1	1	Indoor2	AUXB09LALH
1	0	1	2	Indoor3	AUXB12LALH

Input contents

Adaptor No.	Enter the Adaptor No. (Range: 1 ~ 4)	
Refrigerant	Enter the refrigerant circuit address. (Range: 0 ~ 99)	
Unit	Input "Model" numerically	Enter the unit model. (Inner: 1, Outer: 2)
	Input Unit Address	Enter the unit No. (When "1" is inputted in "Model" field, input within the 0 ~ 3 range. When "2" is inputted in "Model" field, input within the 0 ~ 63 range.)
Name	Enter a name which allows easy classification of units. When a name is entered in this field, it is displayed on the Web Monitoring Tool. Entry is not always necessary. When nothing is entered, the name is displayed as a blank. Only alpha-numeric characters and spaces may be used for the unit name.	
Model Name	Enter a correct model name for each unit, using alphanumeric characters, "-" and "#". If the model name is unknown, keep the cell blank.	

- ③ Select “Microsoft® Excel workbook (*.CSV)” at Save as type. Confirm that the file name extension is [.CSV] and then click the  Save button. (*3)

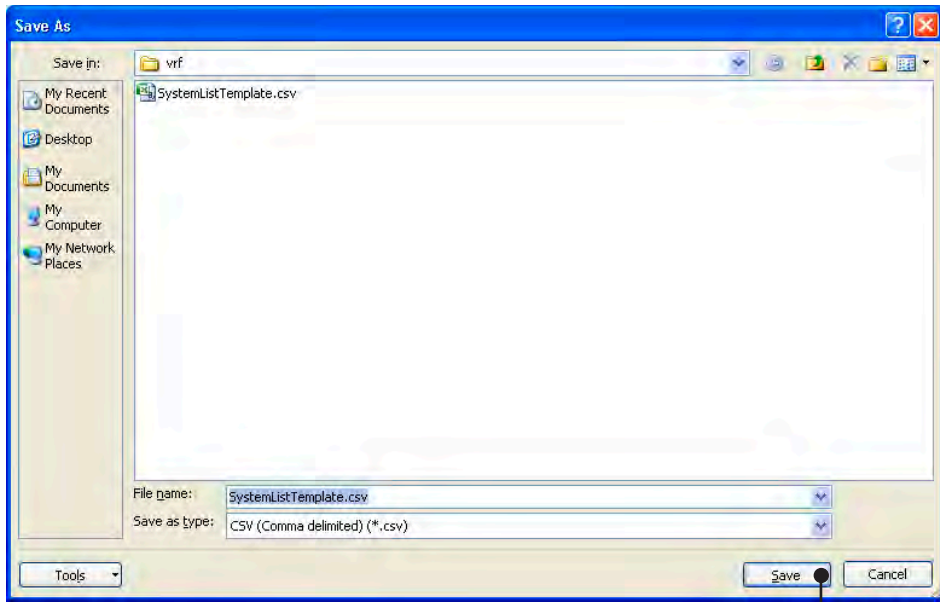

③

- Note**
- *1 This template is created by spreadsheet program Excel. Excel must be purchased separately.
 - *2 [SystemListTemplate.xls] is in the folder specified when installing the Web Monitoring Tool. When an address other than the default installation address was specified, check that folder.
 - *3 Since a CSV file is not created in formats other than “Microsoft® Excel workbook (*.CSV)” at Save as type, it cannot be used at the name master database file selection screen.

3-2-5 Scanning

■ Scanning setting screen

The air conditioner indoor units and outdoor units are connected by a transmission bus line and each have unique address information. Scanning collects this information. Since the Web Monitoring Tool can connect up to 4 transmission adaptors, each adaptor must be set before scanning is performed.

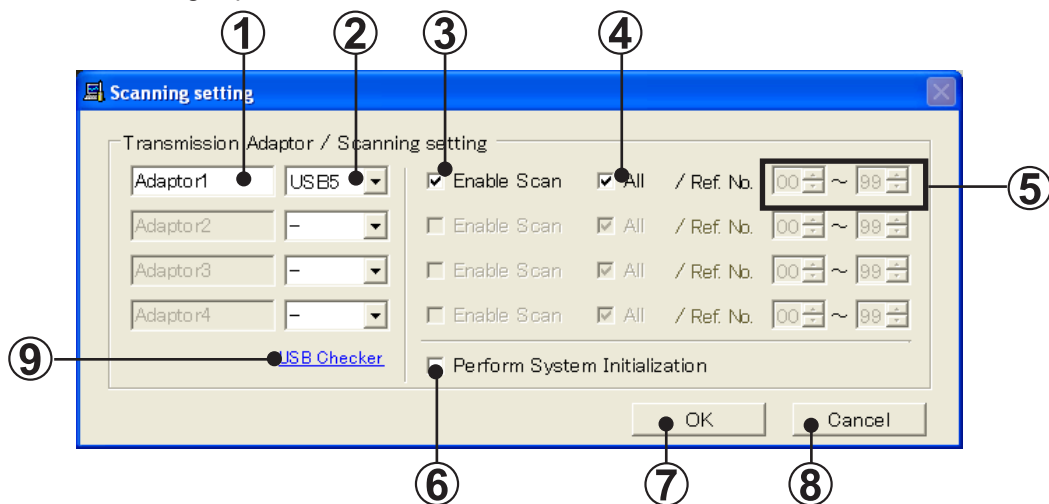

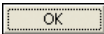
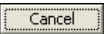
- ①** Transmission adaptor entry field
The transmission adaptors which can be currently used are displayed. Enter the name to identify the transmission adaptor (up to 10 alphanumeric and spaces).
- ②** USB port selection field
Select the USB port which connects the transmission adaptor.
- ③** Scan execution setting check
Check to execute scanning.
Do not check when using existing site data which is currently being read. (*2)
- ④** Ref. No. range (ALL) check
Check to scan all the refrigerant circuit.
At this time, the range of refrigerant circuit addresses to be scanned is automatically set to 00 ~ 99.
- ⑤** Ref. No. range input field
When ALL is not checked at step ④, input the refrigerant circuit addresses to be scanned within the 00 ~ 99 range.
Input the start refrigerant circuit address ~ end refrigerant circuit address range.
- ⑥** Perform System Initialization check
Can be used only when ③ is checked.
Check when you want to acquire more detailed information by scanning. (*1)
When checked, a confirmation screen is displayed. When the  button is clicked, all the units in the VRF System may be temporarily stopped.
When the  button was clicked, the check mark is removed.



7 OK button

- When “Enable Scan” checked

When the button is clicked, scanning starts and scanning progress is displayed on the scanning progress screen.

Before scanning starts, whether or not scanning is to be performed is displayed on a confirmation screen.

When re-scanning, dialog box will appear after selecting the start of scan, confirming whether the existing indoor/outdoor units data (operation data, etc.) may be deleted.



OK button

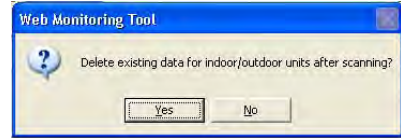

Yes ... delete the data after scanning, No ... Keep the data,

- * When performing scanning selecting “No” and number of units before and after scanning mismatches, following symptom may be encountered. Therefore, when selecting “No”, be sure to have the correct number of units before and after scanning in mind.
 - Transmission error may occur for the units that ceased to exist after scanning.
 - Delay may occur for collecting data for each unit.

- When “Enable Scan” not checked

When the button is clicked, the system list screen is displayed without scanning. But when CSV formatted Name master file (3-2-4) has been already read, the corresponding Name of the unit will be updated.

8 Cancel button

When the button is clicked, the online site selection screen is displayed.

9

USB Checker

This will be used to detect the actual USB port where transmission adaptor is inserted. Note that this will not be displayed if the driver for the U10 USB Network Interface is not installed. This will not be displayed for re-scanning.

<Detection Mechanism>

- Insert the transmission adaptor (U10 Network Interface) into the USB port. (This requires that software installation is already completed).
- When clicking the [USB Checker] in the scanning setting screen, following screen will be displayed.
- In this screen, click the U10 USB Network Interface pull-down list box and select any USB port, then push the [Light] button.
- If the selected USB port is the actual porting connecting the U10 USB Network Interface, [SVC] in this screen and LED (SVC) of the transmission adaptor will flicker 4 times. (If the port differs, there will be no flicker).
- When the USB port No. is confirmed, close the screen and set the USB No. port in the above procedure ② (USB port selection field) the USB port number where U10 USB Network Interface was detected.

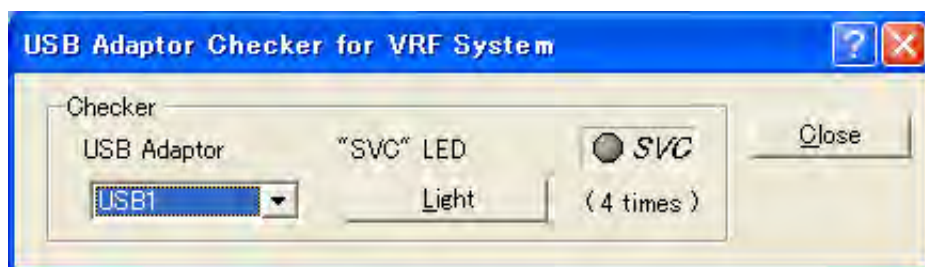

- Note** *1 • When Perform System Initialization checked

Normally, perform bus priority mode scanning. Full scanning which can receive detail data is performed. However, since each unit performs scan dedicated special operation, the units of the entire VRF System temporarily stop. To start scanning, check if the VRF System can be completely stopped, then execute scanning. Since the units remain stopped even when scanning is finished, a restart command must be sent from the control unit.

- When Perform System Initialization not checked

Use when scanning at sites at which the VRF System cannot be stopped. In this mode, scanning can be performed without affecting the operating status of the VRF System. However, since R.C group data cannot be received, it is not full scanning. Operation is not controlled in R.C. group units.

- When Single-Split Adaptor (UTR-YRDA) is connected within the VRF system, be sure to check the "Perform System Initialization" when performing scanning in order to recognized the equipment and display correct information.

- *2 When not checked, since scanning is not performed, the scanning objective refrigerant circuit address cannot be set.

■ Scanning progress screen

Scanning is started and the scanning progress is displayed.

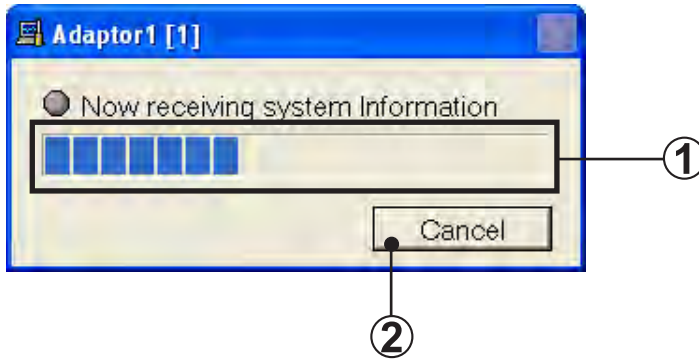

① Scanning progress display field
Displays the progress of scanning.

② Cancel button
When the button is clicked, scanning stops and the program returns to the scanning setting screen.

3-2-6 Mismatched unit list

When a name master database file is specified at par. 3-2-4, the unit data of the database file and the unit data actually scanned are collated. If there is a mismatch, that unit address is displayed. Therefore, correct the address setting on the board of the displayed unit and then re-scan. Repeat this work until a mismatched unit is not displayed.

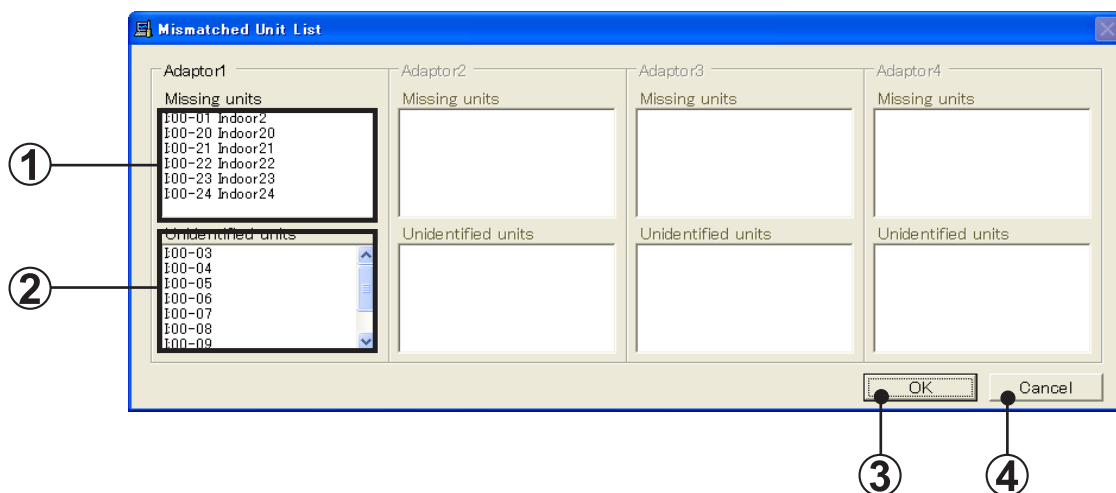

- ① **Missing units address display field**
This field displays the unit addresses and unit names whose unit data is defined by name master database, but the relevant data could not be acquired during scanning.
- ② **Unidentified units address field**
This field displays the unit address and unit model (indoor unit, outdoor unit) whose address was received during scanning, but whose unit data is not defined by name master database file.
- ③ **OK button**
When the button is clicked, the scanning acquisition data is stored and the system list screen (see par. 5-4) is displayed. The application icon is also displayed at the task tray.

If there is a unit mismatch, return to the scanning setting screen by clicking the button and repeat collation with the scanning acquired data until there are no mismatches. After confirming that there are not mismatches, click the button. If the button was clicked when there is a mismatch, the unit data acquired by scanning is displayed on the system list screen unchanged.

- ④ **Cancel button**
When the button is clicked, the program returns to the scan setting screen.



3-3 Data acquisition application starting (automatic starting)

When initial setting (user registration, site registration) was already completed, the data acquisition application is automatically started and the application icon is displayed on the task tray at the 2nd and subsequent startings. (The data acquisition application of the Web Monitoring Tool is also started automatically when the PC was automatically restored from a power failure, etc.)

When you want to perform each type of operation of the Web Monitoring Tool in the state in which the data acquisition application was already started, perform operation from the right click menu of the application icon of the task tray  .

You may also start the Web Monitoring Tool manually when it is not running. When you do so, select “Web Monitoring Tool” in the “VRF System” folder in the “Start Menu”.

You must be logged in as a user that belongs to an “Administrators Group” in order to be able to start the Web Monitoring Tool.

4. Data acquisition application right click menu

4-1 Outline

4-1-1 Menu

A menu is displayed and various operations can be performed by right-clicking the  application icon on the task tray.

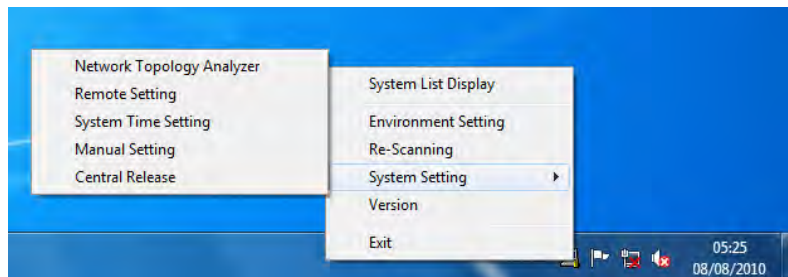

System list display	System list screen is displayed.
Environment setting	Environment setting screen is displayed.
Re-Scanning	Name master database selection screen is displayed.
System Setting	System setting sub-menu is displayed.
Network Topology Analyzer	A list of units connected to the VRF system network is displayed in network segments in tree form. (VII/JII series)
Remote Setting	Function (Field) Setting for indoor unit is realized remotely. (VII/JII series)
System Time Setting	An arbitrary time is set for all the remote controllers within the system. (VII/JII series)
Manual Setting	Manual setting screen is displayed.
Central Release	The operation setting restriction function of the indoor units set from the controller can be forcibly released. (VII/JII series)
Version	Version information screen is displayed.
Exit	Exit confirmation screen is displayed.

4-1-2 Screen transition (online)

The following shows transition of the screens which are started from the right click online menu.

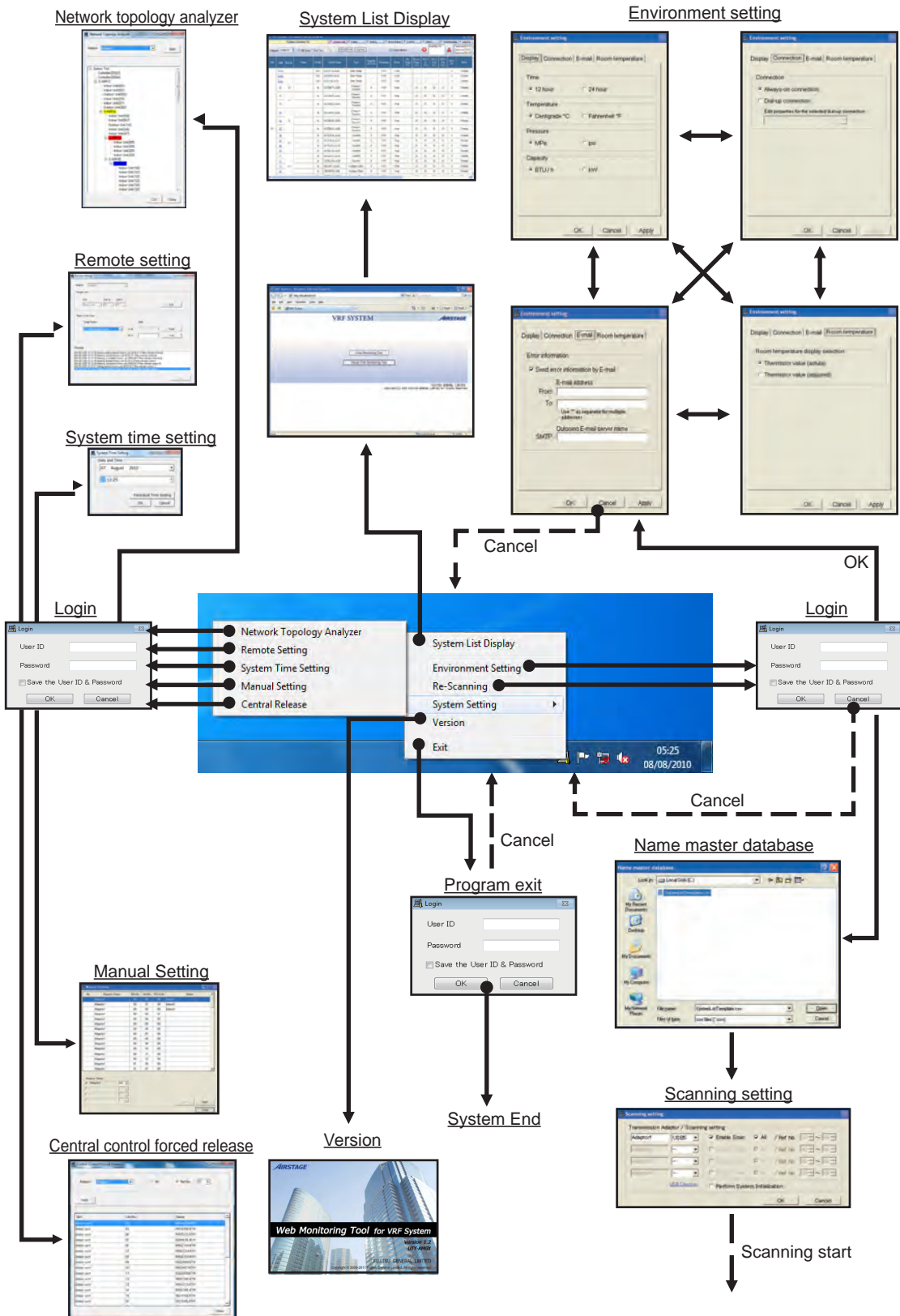

4. Data acquisition application right click menu

4-2 Web browser starting (menu screen)

This is the initial screen. It displays Web Monitoring Tool starting and version information.

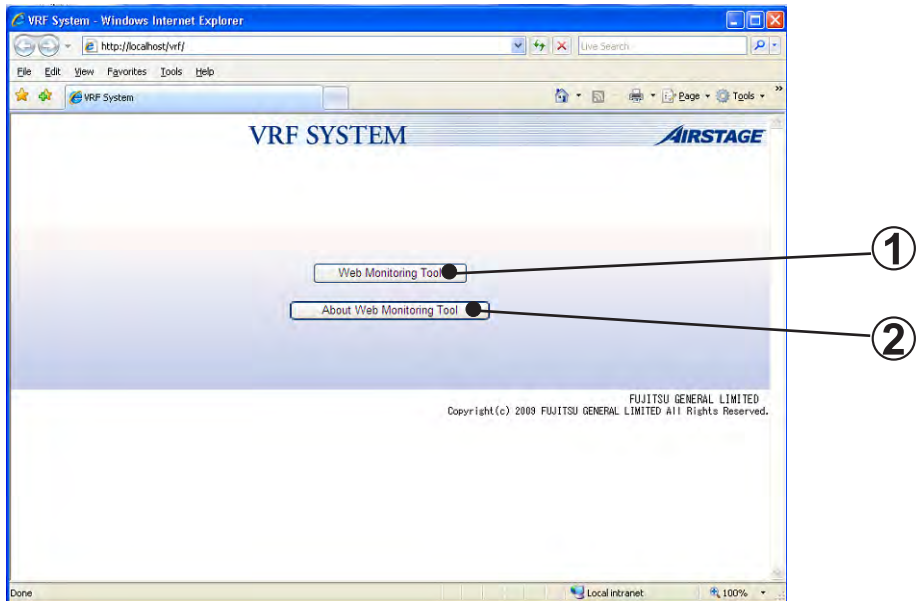

① Displays the login screen.

② Displays the version information.

Note



* For details, refer to par. 5-2 Menu.

4-3 Environment setting

Various settings related to the operating environment are performed.

Display tab: Sets the Time/Temperature/Pressure/Capacity display method.

Connection tab: Sets the transmission mode.

E-mail tab: Sets the notification destination e-mail address when an error occurs.

Room temperature tab: Sets the room temperature display method.

4-3-1 Display setting

Sets the display method of the Time/Temperature/Pressure/Capacity to be displayed by the Web application.

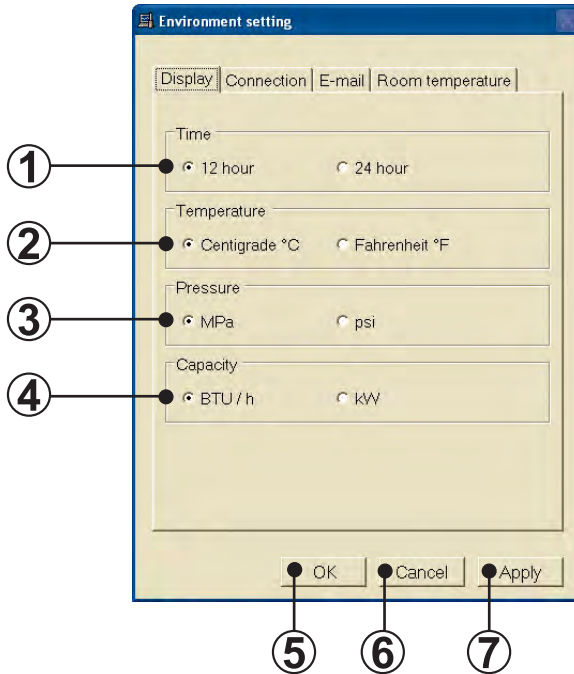

- 1** Time display selection item
Sets the time display format.
For 12-hour display format, select “12 hour”. For 24-hour display format, select “24 hour”.
- 2** Temperature selection item
Sets the temperature display units.
When you want to display the temperature in centigrade, select “Centigrade °C”.
When you want to display the temperature in fahrenheit, select “Fahrenheit °F”.
- 3** Pressure selection item
Select the pressure display units from “MPa” or “psi”.
- 4** Capacity selection item
Select the capacity display units from “BTU/h” or “kW”.

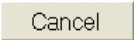
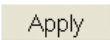
- ⑤ **OK button**
When the  button is clicked, the set contents are saved and the screen is closed.
- ⑥ **Cancel button**
When the  button is clicked, environment setting stops and the screen closes.
- ⑦ **Apply button**
When the  button is clicked, the set contents are saved.

Note  After changing the display settings, the changes will take effect only from the Web application newly started from the Menu screen.
In order for the changes to take effect, re-display the Web application from the Menu Screen (Refer to section 5-2).

4-3-2 Transmission mode setting

The transmission mode with the internet connection provider is set. When sending error notification e-mail, connection to the internet and transmission of the e-mail are performed by the method set here. Set the transmission mode to match the usage environment. When dial-up connection was selected, e-mail transmission processing is performed after the dial-up connection name set here is automatically dialed and connected to the internet. (*1) When constant connection was selected, e-mail transmission processing is performed unchanged.

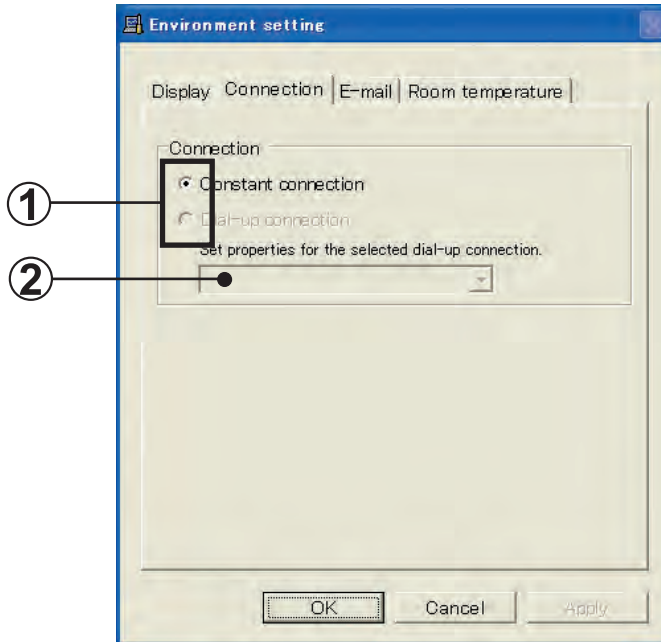

- ① Connection mode selection items
When the connection mode is constant connection, select "Constant connection". For dial-up connection, select "Dial-up connection".
- ② Dial-up selection field
When "Dial-up connection" was selected at ①, select the dial-up connection name to be used.

Note (*1) When using dial-up connection, it necessary set the Windows network setting so that line disconnects automatically.
For the dial-up connection in use;
Open "Properties" window, select "Option" tab, then set "Idle time before hanging up" to 1 minutes

4-3-3 Error notification e-mail setting

By performing setting, e-mail can be sent to a pre-registered place when an error was generated at the air conditioner. (*1) The notification destination e-mail address when an error occurs is set at this screen.

When setting was performed, check whether or not an error is generated at a 5 minutes interval. When a new error was generated, or an error was not sent, the data is collected and sent as 1 e-mail.

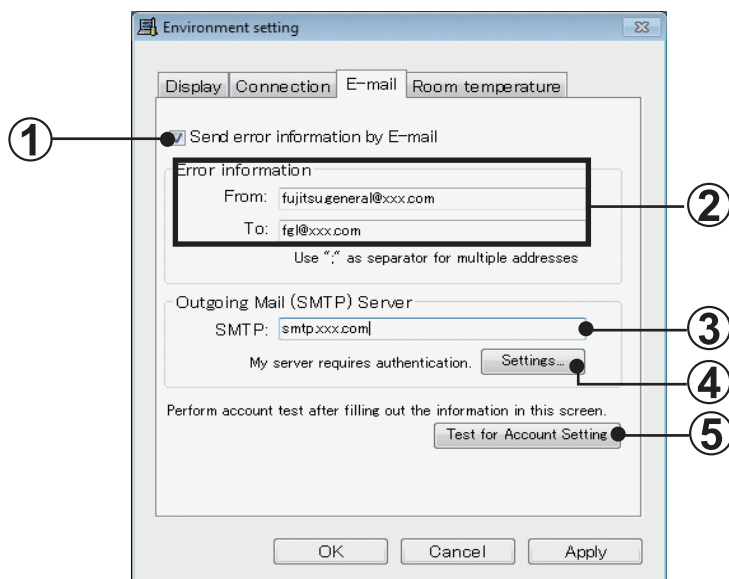

- ①** Error notification check
Check to send a notification e-mail when an error is generated.
When not checked, error e-mail is not sent.
- ②** Transmission address input field
When “Send error information by E-mail” was checked at ①, input the error notification Sender & receiver e-mail address. (*2)
- ③** E-mail server name input field.
Input the E-mail (SMTP) server name.
- ④** Settings... button
Opens the mail authentication setting screen.
- ⑤** Test for Account Setting button
Sends a test mail by current set value (set value at ① to ③ and mail authentication screen).
When the button is clicked, a transmission result message is displayed.

- Note** (i) (*1) A contract with the internet connection provider is necessary. In addition, perform par. 4-3-2 Transmission mode setting based on the transmission mode with the internet connection provider.
- (*2) E-mail is sent under the title InformationVRF (Error Notice).

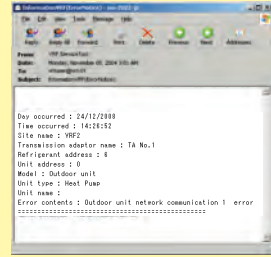

4-3-4 Mail Transmission Authentication Setting

When [Setting...button] is clicked at 4-3-3 ④, "Mail Transmission Authentication Setting" screen is displayed.

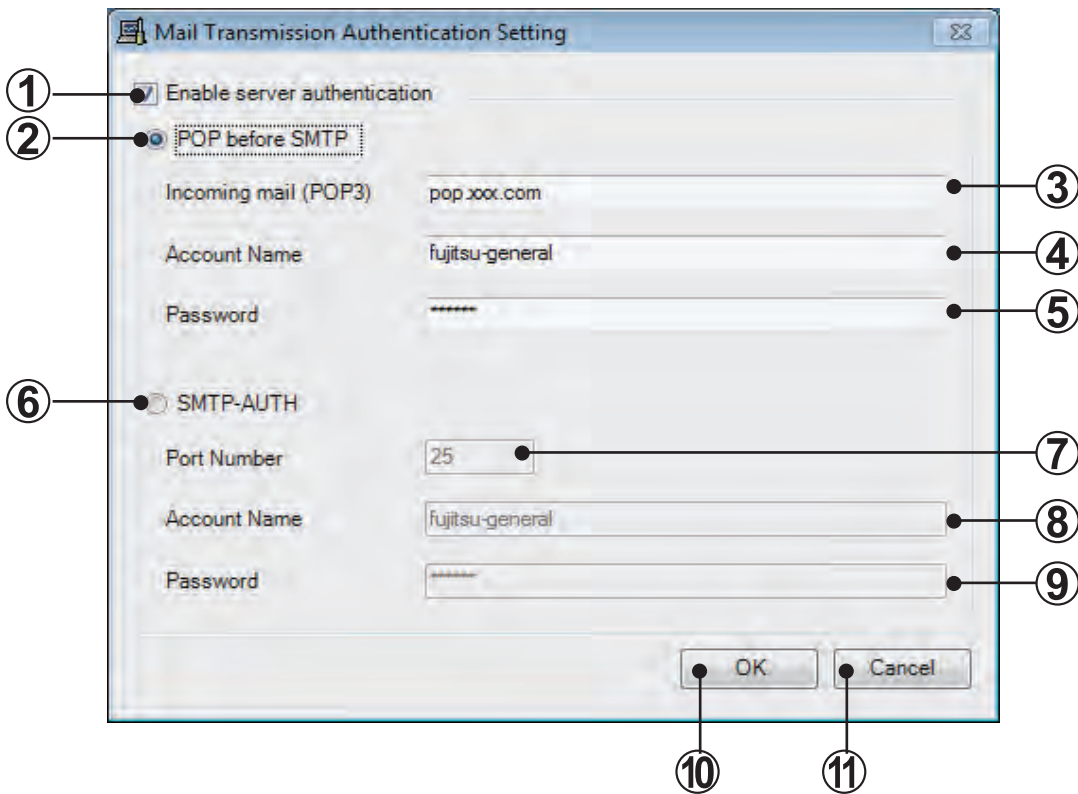

- ① Enable server authentication check
Select whether or not mail transmission authentication is performed. If checked, authentication is performed. If not checked, authentication is not performed. When checked, ② or later items below can be set.
- ② POP before SMTP authentication check
Select the mail transmission authentication method.
Set values of ③ to ⑤ can be changed.

- ③ Incoming mail (POP3)
Enter the name and IP address of POP server used.
- ④ Account Name
Enter the account name of POP server.
- ⑤ Password
Enter the POP server password. All passwords are displayed by “*”.
- ⑥ SMTP-AUTH (authentication) check
Select the mail transmission authentication method.
Set values of ⑦ to ⑨ can be changed.
- ⑦ Port Number
Enter the port number used.
- ⑧ Account Name
Enter the account name of SMTP server.
- ⑨ Password
Enter the SMTP server password. All passwords are displayed by “*”.
- ⑩ OK button
Save the set value and close the screen.
- ⑪ Cancel button
Cancel the set value and close the screen.

4-3-5 Room temperature display setting

Sets the display method of the room temperature to be displayed by the Web application.

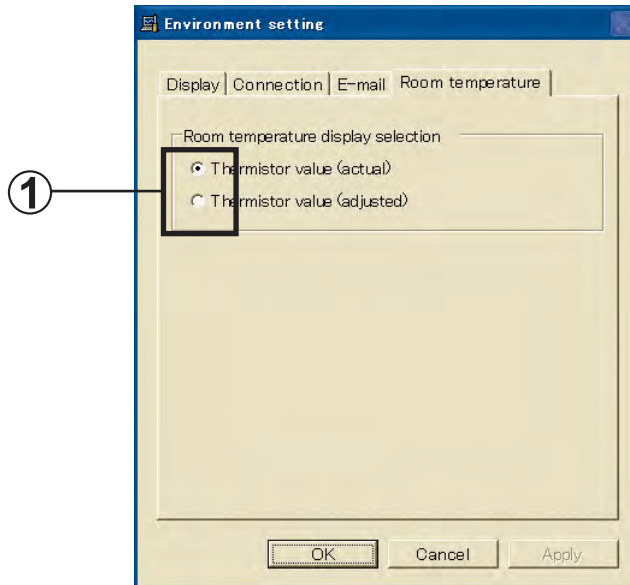

① Room temperature selection item

When you want to display the room temperature detected by sensor unchanged, select "actual". When you want to display the room temperature corrected (used in control) by the unit, select "adjusted".

Note



After changing the display settings, the changes will take effect only from the Web application newly started from the Menu screen.

In order for the changes to take effect, re-display the Web application from the Menu Screen (Refer to section 5-2).

For S series, only thermistor value (actual) is displayed.

4-4 Re-scanning

Before re-scanning is performed, the login screen of par. 3-2-2 is displayed. After user authentication is performed, perform operation by the procedure described in par. 3-2-4. For the scanning method, refer to par. 3-2-5.

4-5 System Setting

4-5-1 Network Topology Analyzer

A list of units connected to the VRF system network is displayed in tree form in network segments. (VII/JII series)

This information is also output to a CSV file.

Network Topology Analyzer Screen

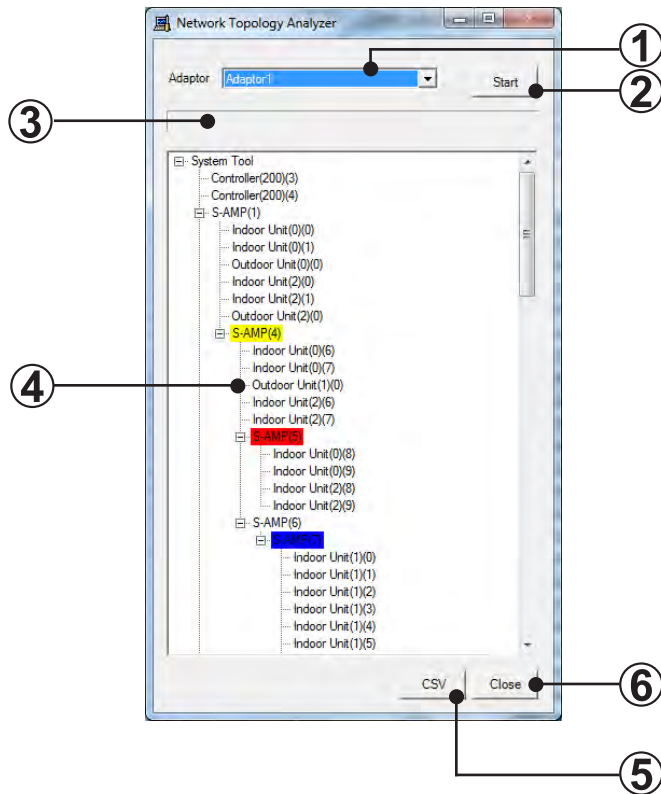

- ① Adaptor selection
Selects the transmission adaptor which acquires the connection data.
- ② Start button
Starts this processing.

Note It takes about 1 hour by the end of this process from start.



3 Progress bar
Displays the progress of this processing.

4 Network Topology display
Displays in tree form the data acquired when this tool (System Tool) started.

Notation contents

S-AMP(X)···Signal Amplifier (address)

Blue background: When the number of units connected in 1 segment exceeded 64.

Red background: When the address of signal amplifier is redundant.

When matched up to the connection point, S-AMP(x) count (number duplicated) is displayed.

Yellow background: When data cannot be acquired from signal amplifier, but they exist in the data acquired from another unit (indoor unit, etc.).

White background : Normal state other than the above.

Indoor Unit(X)(Y)···Indoor unit (refrigerant circuit address)(unit address)

Outdoor Unit(X)(Y)···Outdoor unit (refrigerant circuit address)(unit address)

Controller(X)(Y)···Peripheral unit (system address)(unit address)

When the same address exists in indoor unit, outdoor unit, and controller respectively, red background is displayed.

5 CSV button
The information displayed at **4** can be saved to CSV file.

[CSV configuration]

- Communication data (reference data) of each unit acquired by this processing

Note



Since the address of each unit is the address used in communication, it is different from the screen display address.

- Tree display displayed on the screen

Note



- The signal amplifier background color is replaced by the following symbols.
White : None / Blue: * / Red: ** / Yellow: ***
- The indoor unit, outdoor unit and controller background color are replaced by the following symbols.
White: None / Red: **

6 Close button
Closes this screen.

4-5-2 Remote Setting

Function (Field) setting can be performed for indoor units by remote controller. (VII/JII series)
(Some settings cannot be supported.)

The processed result can also be output to a CSV file.

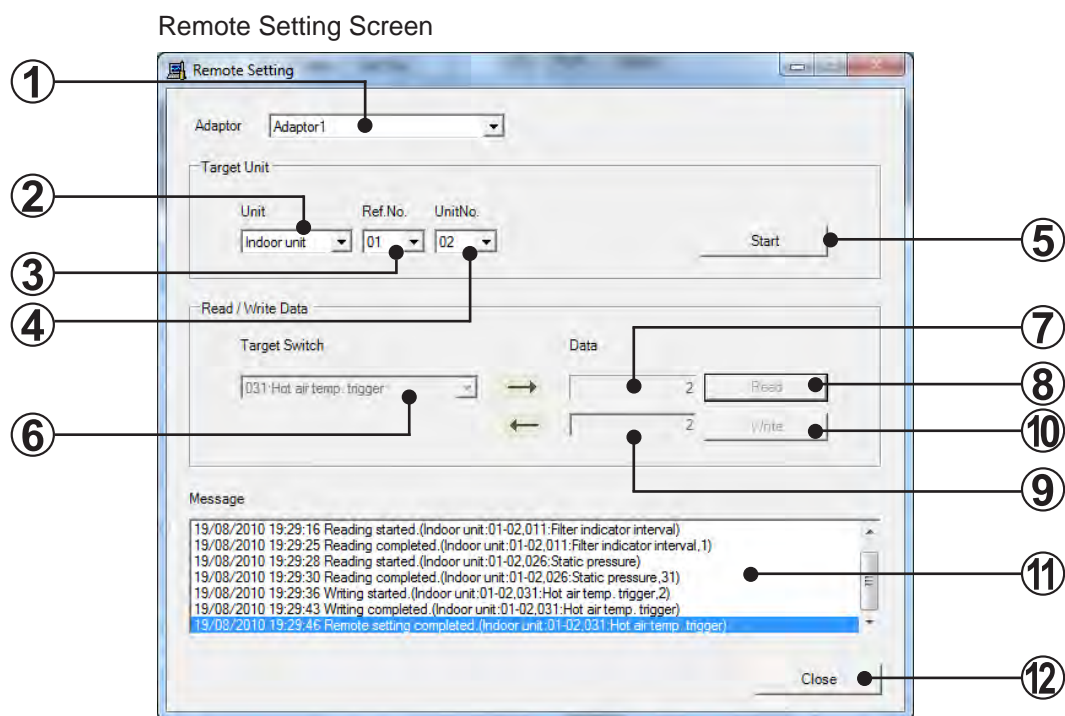

- ① **Adaptor selection**
Selects the transmission adaptors which connect the system containing units which perform processing.
- ② **Unit type**
Selects the unit type of the unit which is to perform processing.
- ③ **Refrigerant No.**
Selects the refrigerant circuit address of the unit which is to perform processing.
- ④ **Unit No.**
Selects the unit address of the unit which is to perform processing.
- ⑤ **Start button (End button)**
Switches the indoor unit specified at ① to ④ to the Function(Field) setting mode.
At this time, operation of all the indoor units of the refrigerant circuit to which the target indoor unit belongs stop.
In addition, when you want to stop using this function, click this button (End button)
- ⑥ **Target switch**
Displays the item of the local Function(Field) setting item. (No + name)

- ⑦ **Read value**
Displays the value of the item selected by ⑥ SW specification combo box read from the unit specified by ① to ④.
By clicking the Read button, read processing is started and the value acquired as a result is displayed.
- ⑧ **Read button**
Acquires the value of the item selected by ⑥ SW specification combo box from the unit specified by ① to ④ and displays it to the Read value label.
- ⑨ **Set data input**
Inputs the write value to the item selected at ⑥ SW specification combo box to the unit specified by ① to ④.

Note For the set value of each Function, refer to the “DESIGN & TECHNICAL MANUAL” or the “INSTRUCTION MANUAL” packed with the indoor unit.

- ⑩ **Write button**
Executes setting of the value specified by ⑨ for the unit specified by ① to ④. Thereafter, the result of the set contents is displayed at ⑦. (For confirmation)
- ⑪ **Message**
Displays the result of execution when each button (except the Close button) is clicked.
- ⑫ **Close button**
Closes this screen (remote setting screen). However, when read/write processing to unit was performed, confirmation dialog box opens to confirm whether to save the data to a CSV file.

4-5-3 System Time Setting

An arbitrary time can be set for VRF System remote controller. (VII/JII series)
Automatic time adjustment can also be executed periodically.

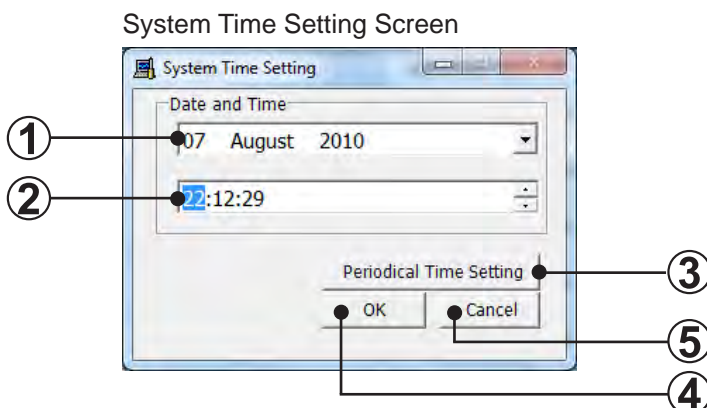

Date and Time Setting Screen

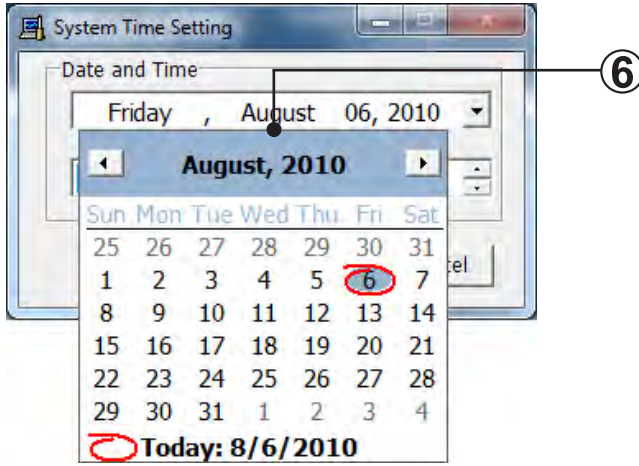

Periodical Time Setting Screen

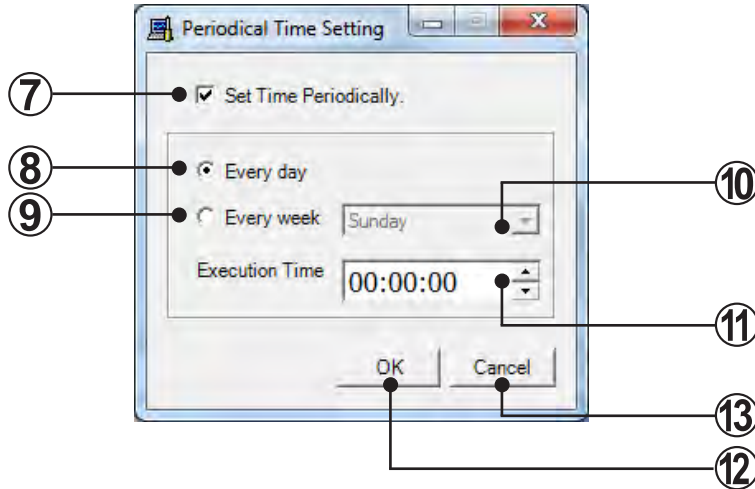

- ① **Date**
Specifies the date to be set. When this specification field is selected, calendar ⑥ is displayed.
The initial display is the current date.
- ② **Time**
Specifies the time to be set. The initial display is the current time.
- ③ **Periodical Time Setting button**
When clicked, periodical time setting dialog box opens.
- ④ **OK button**
Executes date/time setting using the contents specified at ① ②.
- ⑤ **Cancel button**
Closes this screen.

- ⑥ Calendar
Arbitrarily selects from a calendar the date to be set.
- ⑦ Periodical Time Setting check box
When checked, time setting is executed periodically at the date/time of ⑧ to ⑪
- ⑧ Every day button
When checked, the clock is set to the right time at the time set at ⑪ Execution time every day.
- ⑨ Every Week button
When checked, the clock is set to the right time at the time set at ⑪ Execution time of the day of week at ⑩ Day of week setting combo box.
- ⑩ Day of week setting
Selects the day of week at which the clock is set to the right time when ⑨ Every week radio button is checked.
- ⑪ Execution Time setting
Specifies the time setting of clock to the right time is to be executed.
- ⑫ OK button
Enters the set contents of ⑦ to ⑪ and closes the periodical time setting dialog box.
- ⑬ Cancel button
Cancels the set contents of ⑦ to ⑪ and closes the periodical time setting dialog box.

4-5-4 Manual Setting

Manual unit name registration by manual setting can be performed. Manual setting enables you to register the names for each scanned unit, by operating each unit ON, one by one.

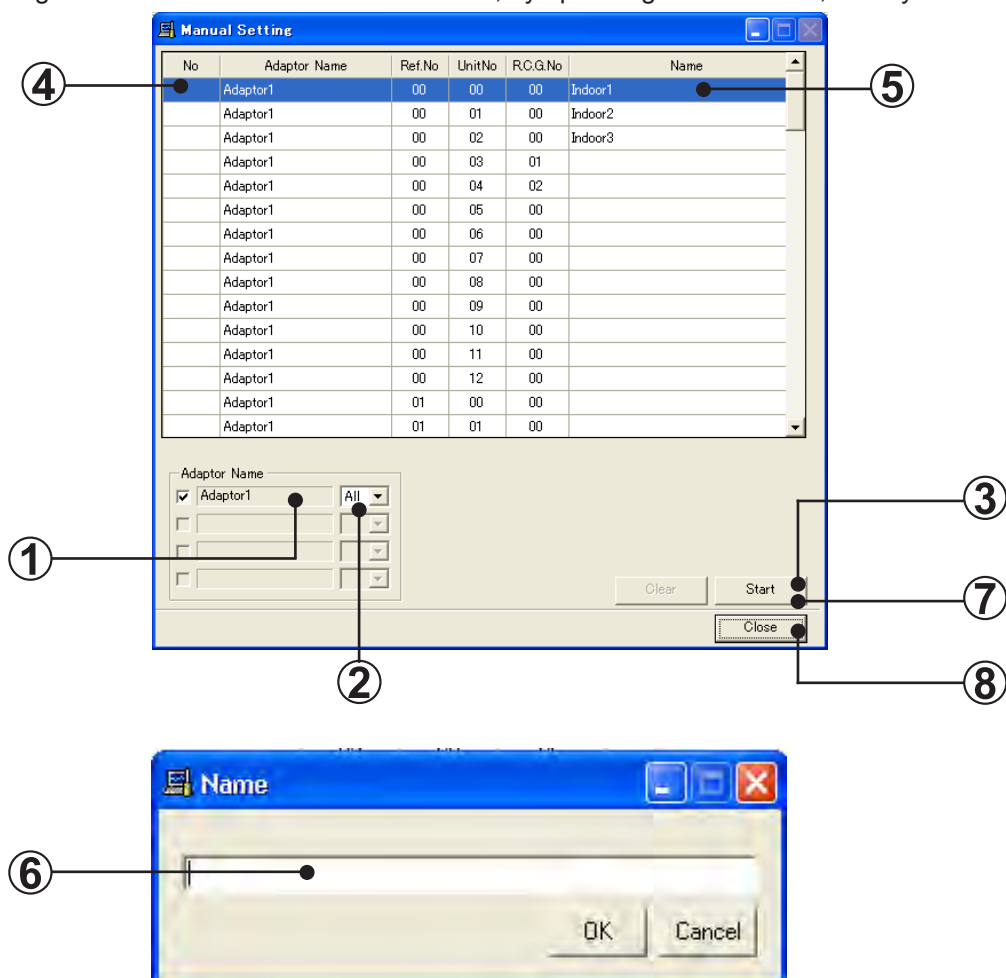

- ① Adaptor selection
Select the network to which manual setting operation is to be performed, by checking the transmission adaptor.
- ② Select "All" or the desired refrigerant circuit address to perform manual setting operation.
- ③ Start registration
Click to start. When manual setting operation starts, this button changes to "Stop".
- ④ Unit operation
Go to the unit location and start the unit operation with a remote controller. The units started will be listed in the order they are started on this list and will be numbered in that order.
- ⑤ Selecting units

When units are recognized and numbered, double click on the unit. The name registration dialog box will appear.

- ⑥ **Naming units**
Enter the name for the unit and click “OK”.
- ⑦ **Stop registration**
Click “Stop” when finished with the registration.
- ⑧ **End registration**
Click “Close” to end manual setting registration.

Note Instead of registering names for each start operation, you may operate all the units and name all the units at once after stopping registration.



4-5-5 Central Release

The operation setting restriction function (remote controller inhibit, temperature upper/lower limit setting) set from the controller can be forcibly released. (VII/JII series)

When the controller cannot be used for various reasons, the condition can be released and the controller can be used by this function.

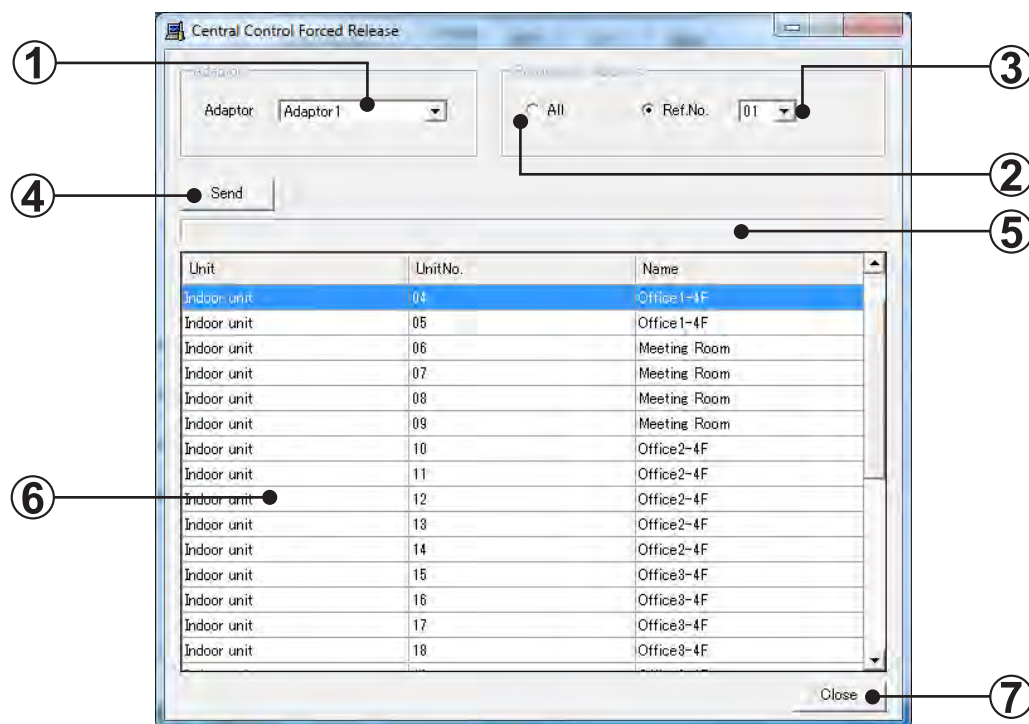

- ① **Adaptor selection**
Selects the transmission adaptor which connects the target unit.
- ② **Refrigerant circuit all selection**
Selects the target refrigerant circuit address. Makes the selection from 2 types of all refrigerant circuit and refrigerant circuit 1 as the type of selection.
- ③ **Refrigerant circuit address selection**
An arbitrary target refrigerant circuit address can be selected.
At this time, the indoor units belonging to the selected refrigerant circuit are displayed at ⑥.
- ④ **Send button**
Execute Central Control Forced Release for the target indoor unit.
- ⑤ **Progress bar**
Display the progress of Send.
- ⑥ **Unit list**
Displays the indoor units belonging to the refrigerant circuit selected at ③.
Also selects the target indoor unit of this processing.

7

Close button
Closes this screen.

4-6 Exiting

To exit the Web Monitoring Tool, user authentication is necessary. This is a measure so that the Web Monitoring Tool is not exited improperly by a user other than the related user. Since the login screen of par. 3-2-2 is displayed when Exit is selected, input the user ID/password.

The Web Monitoring Tool can be exited only when the user was authenticated.

5. WEB application

5-1 Screen transition

5-1-1 Web application starting conditions and functions change

The functions of the Web application depend on the starting location of the user and login user level.

The functions which must be performed (operation control, commissioning tool, setting) while actually grasping the state of the air conditioner are restricted so that operation can only be performed from the Server (on the site installation PC on which the Web Monitoring Tool is installed).

Login User level	Starting location	
	Server	Client
Level1	○	△
Level2	△	△

○ : All functions are usable.

△ : All functions except control, commissioning tool, and setting screen are usable.

■ Web application setting method

- Starting by Server

The Web application is started from the right click menu of the resident application by a PC which is operated by the Web Monitoring Tool. For the starting method, refer to Chapter 4.

- Starting from Client

To connect to the Server and use the functions of the Web Monitoring Tool from a remote PC, start the browser and specify the Service installed on-site at the address specification field as follows:

"<http://<IP address>/vrf/>" or "<http://<computer name>/vrf/>"

Example)

When the IP address is 192.168.100.100, it is specified by http://192.168.100.100/vrf/.

The <IP address> and <computer name> specification method depends on the connection environment.

Connection environment	Specification method
LAN	Private IP address or computer name
Internet	Specifies the global IP address which subscribed to fixed IP service or the DNS name which subscribed to DNS service as the computer name.
Internet (VPN)	Private IP address or computer name
Incoming connection	IP address or computer name allocated by RAS

Note "<" and ">" do not have to be input at <IP address> and <computer name>.
 For the global IP and private IP concept, refer to the documentation and network related books from the provider.

■ User level

With the Web Monitoring Tool, the functions which can be used can be restricted by setting authority to the user.

Level1 : All functions can be used when started from the data acquisition application.

Level2 : All functions except control, commissioning tool, and setting can be used.

For the user Level modification method, refer to par. 5-13-2.

5-1-2 Screen transition

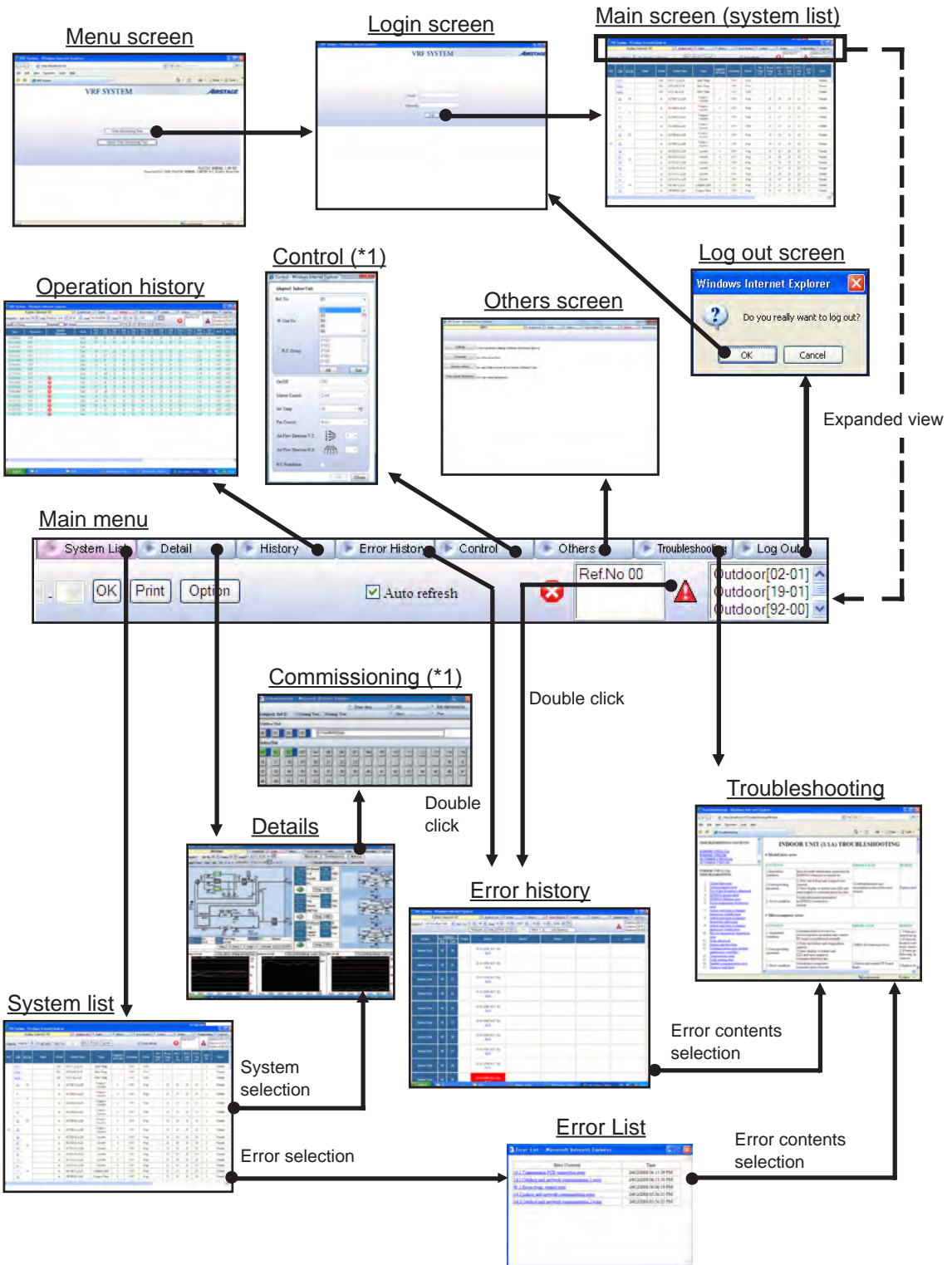

Note *1 For starting from Client and when logged in by Level 2 user, since functions are restricted, they cannot be used.

Screen	Function	Page
Menu screen	Initial screen. Starts the Web Monitoring Tool and displays the version information	48
Login screen	Inputs and logs in the relevant user ID and password.	49
System list screen	Lists the status of each unit and the overall operating status can be grasped. This screen is displayed when shifting from the menu screen.	51
Details screen	Performs normal operation check and cause specification when an error was generated from the detailed status display of the units.	58
Commissioning tool	Test run instructions and commissioning data storage can be performed.	74
Operation history screen	Displays the indoor units or outdoor unit operating history information for each unit.	83
Error history screen	Displays the error information for each unit.	92
Control screen	Operation of each refrigerant circuit, indoor unit, or R.C. group can be controlled.	100
Others screen	<ul style="list-style-type: none"> • Performs new user registration, user password change, registered user deletion, and demand interval setup. • Save/Download data • Setting Auto-refresh interval and maximum No. of lines per page. • Time Guard Information is acquired from a unit and the CSV file output. 	102
Troubleshooting screen	Displays the error contents and corrective action	114
Log out screen	Logs out.	115

5-2 Menu

It starts the Web Monitoring Tool and displays the version information.

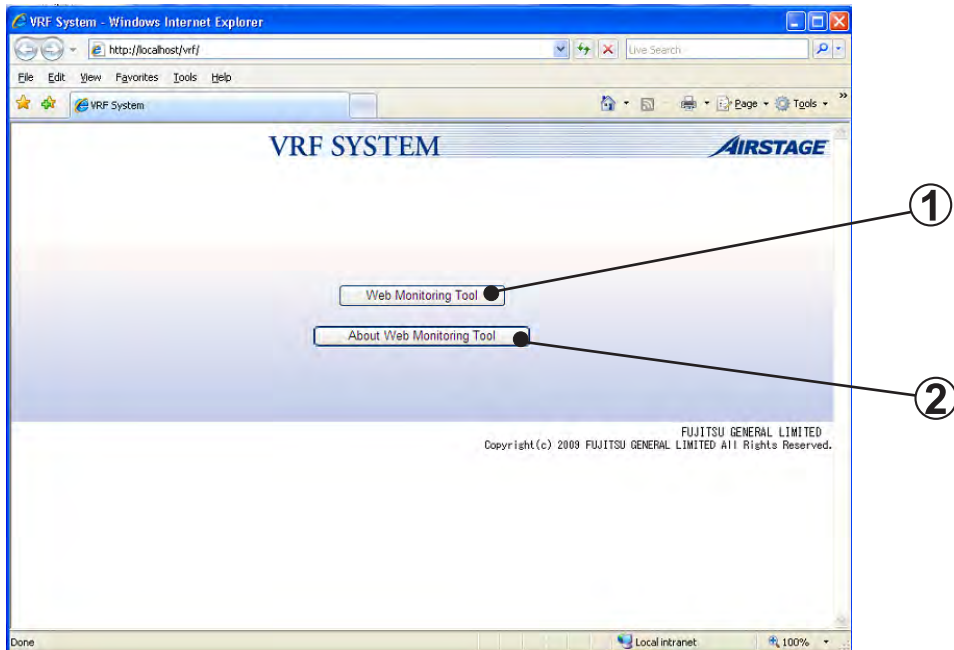

- 1** Web Monitoring Tool button
Starts the Web Monitoring Tool, and displays the detail screen.
- 2** About Web Monitoring Tool button
Displays the version information.

5-3 Login screen

Inputs and logs in the relevant user ID and password.

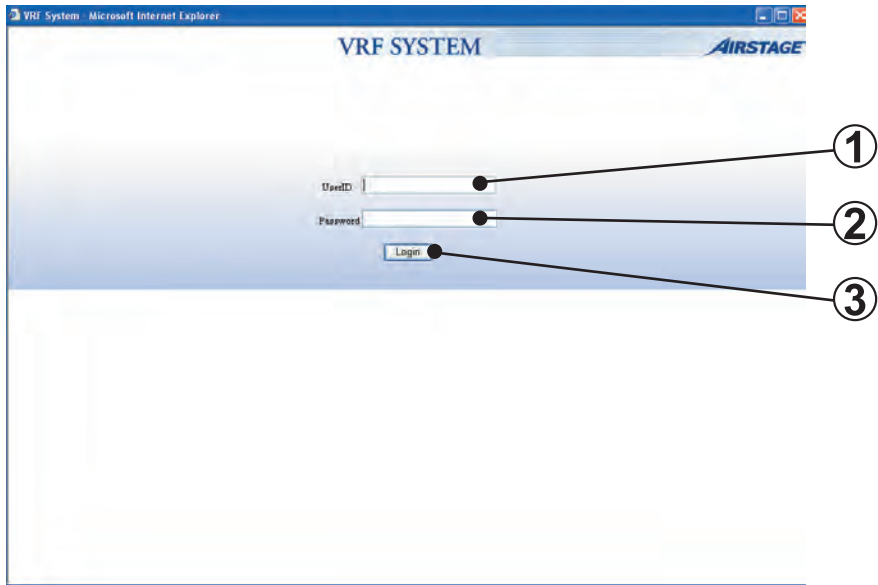

- ① User ID input field
Input the ID of the user to be logged in. (Up to 20 alphanumeric characters) (*1)
- ② Password input field
Input the password of the user to be logged in. (Up to 20 alphanumeric characters) (*1)
- ③ Login button
When the button is clicked, the system list screen is displayed. (*2)

Note





- *1 When the user ID and password entry field are not input, an error message is displayed.
- *2 When the entered user ID and password are not registered, an error message is displayed and that user cannot login.

5-4 Main menu

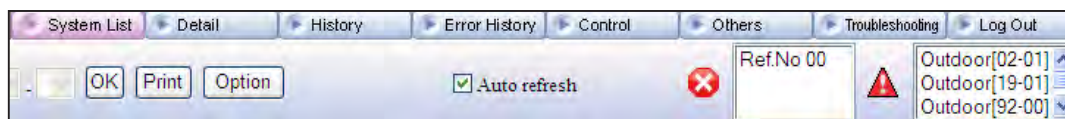
Menu which is displayed at the top of the screen. Each time the button is clicked, the display shifts to the screen of the next function.



System List	Shifts to the system list screen.
Detail	Shifts to the detail screen.
History	Shifts to the operation history screen.
Error History	Shifts to the error history screen.
Control	Displays the control screen. (*1)
Others	Shifts to the others screen. (*1)
Troubleshooting	Displays the troubleshooting screen.
Log Out	Logs out
 (Emergency Stop)	Displays refrigerant circuit where emergency stop is activated.
 (ERROR)	Up to 20 addresses of units currently generating an error can be displayed, beginning from the newest unit. Shift to the error history screen by double clicking the unit.

Note *1 For starting from client and when logged in by Level 2 user, since functions are restricted, they cannot be used.



5-5 System list screen

This screen grasps the overall operating status from a list of the status of each unit. When an error unit is detected at this screen, shift to the system detail screen (refer to 5-6) and then check the detailed status. This screen can also be printed.

5-5-1 Name and function of each area

Control area

Ref.	Unit	R.C.G.	Name	Model	Model Name	Type	Capacity (BTU/h)	Operation	Mode	Set Temp. (°C)	Room Temp. (°C)	In (°C)	Mid (°C)	Out (°C)	EVF (P)	Error
00.01				Out	AJYA72LALH	Heat Pump	-	ON	Cool	-	-	-	-	-	0	Normal
01.01				Out	AJYA90LALH	Heat Pump	-	ON	Cool	-	-	-	-	-	0	Normal
02.02				Out	AJY108LALH	Heat Pump	-	ON	Cool	-	-	-	-	-	0	Normal
00	00			In	AUXB07LALH	Compact Cassette	0	OFF	Stop	-	20	20	20	20	0	Normal
01		01		In	AUXB09LALH	Compact Cassette	0	OFF	Stop	-	20	20	20	20	0	Normal
02				In	AUXB12LALH	Compact Cassette	0	OFF	Stop	-	20	20	20	20	0	Normal
03				In	AUXB14LALH	Compact Cassette	0	OFF	Stop	-	20	20	20	20	0	Normal
04		02		In	AUXB18LALH	Compact Cassette	0	OFF	Stop	-	20	20	20	20	0	Normal
05				In	AUXB24LALH	Compact Cassette	0	OFF	Stop	-	20	20	20	20	0	Normal
06				In	AUXD18LALH	Cassette	0	OFF	Stop	-	20	20	20	20	0	Normal
07				In	AUXD24LALH	Cassette	0	OFF	Stop	-	20	20	20	20	0	Normal
08				In	AUXA30LALH	Cassette	0	OFF	Stop	-	20	20	20	20	0	Normal
09				In	AUXA36LALH	Cassette	0	OFF	Stop	-	20	20	20	20	0	Normal
10				In	AUXA44LALH	Cassette	0	OFF	Stop	-	20	20	20	20	0	Normal
11				In	AUXA54LALH	Cassette	0	OFF	Stop	-	20	20	20	20	0	Normal
12				In	ARXB07LALH	Compact Duct	0	OFF	Stop	-	20	20	20	20	0	Normal
13				In	ARXB09LALH	Compact Duct	0	OFF	Stop	-	20	20	20	20	0	Normal

Display item

Control area

Adaptor	Displays the name of the transmission adaptor being used.
All Units	Displays all the units.
Ref. No.	Specifies the refrigerant circuit address. (narrow down display)
OK	Specified condition. Refreshes the display screen.
Print	Prints the currently displayed list.
Option	Set whether the column should be displayed or hidden.
Auto refresh	Specifies automatic refreshing of the display data. Checked: Automatically refresh the screen at a 30 seconds interval. Unchecked: Do not automatically refresh the screen.

Display items







Ref.	Displays the refrigerant circuit address.
Unit	Displays the unit No. and master / slave operation for outdoor unit. Shifted to unit detail screen of the selected unit No. by click operation.

R.C.G.	Displays the R.C. Group No.
Name	Displays the unit name.
Model	Displays the unit model (Indoor/Outdoor).
Model Name	Displays the model name of the unit. If the model name is with “[]” brackets, the name was written after shipment. If the model name is with “()” brackets, the name was read from the Name master database file.
Type	Displays the unit type.
Capacity	Displays the indoor unit capacity. Indoor unit capacity is displayed in [BTU/h] or [kW] units. (*1)
Operation	Displays the operating status.
Mode	Displays the operating mode.  icon, if displayed, signifies that mode mismatch has occurred due to illegal operation. When “(Auto)” is displayed, operation is linked to the “Auto” mode of the master indoor unit of the refrigerant circuit.
Set Temp.	Displays the setting temperature. (*1)
Room Temp.	Displays the room temperature. (*1)
H.E.1. In	Displays the heat exchanger inlet temperature. (*1)
H.E.1. Mid	Displays the heat exchanger middle temperature. (*1)
H.E.1. Out	Displays the heat exchanger outlet temperature. (*1)
EEV	Displays expansion valve. Units display is [Pulse].
Error	When a unit is currently generating an error, displays [Error]. The troubleshooting screen (refer to 5-15) is displayed by clicking.
Special Operation	Displays special operation with icon. Refer “List of icon for special operation” below.
Fan	Displays the fan status. (*3)
V.T. Louver	Displays vertical louver position.
H.Z. Louver	Displays horizontal louver position.
R.C. Prohibition	Displays the R.C. Prohibition setting. * Display whether the “All prohibition” is enabled or disabled.
Time	Displays the newest receiving time of a transmission packet received by the Web Monitoring Tool. (12-hour display or 24-hour display) (*2) • For summer time, (S) is displayed. Whether or not network communication is performed normally is made the judgment standard.









- Note**  *1 Units display is [°C] or [°F]. The display format depends on the setting at the data acquisition application. (Refer to 4-3 Environment setting.)
- *2 The display format depends on the setting at the data acquisition application.
- *3 Sometimes, it may take time for the FAN status display to be updated in the System List screen. The delay time is proportional to the number of existing indoor units and may take approximately 2 minutes for 100 indoor units (the time does not have anything to do with the number of indoor units being controlled). In any case, the actual control operation to the indoor units are performed immediately after control operation from the Control screen, only the display delays.

■ List of icon for special operation

Outdoor unit

ICON	EXPLANATION
	Oil recovery operation
	Maintenance mode
	Emergency stop
	Outdoor unit stopped
	Defrost operation
	Night mode operation
	Power save operation

Indoor unit

ICON	EXPLANATION
	Freeze prevention operation
	Anti-freeze operation
	Anti-freeze setting
	Maintenance mode
	Master indoor unit
	Operation mode controlled by master outdoor unit
	Operation mode controlled by master indoor unit
	Emergency stop
	Energy save operation

5-5-2 System list display

Only the necessary units can be displayed by specifying the refrigerant circuit range. This is convenient when you want to display only the objective unit in the state in which a large number of units are connected to the system.

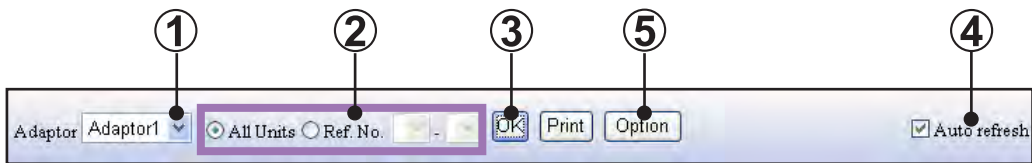

- ① Select the displayed transmission adaptor.
Up to 4 transmission adaptors can be connected at the Web Monitoring Tool. Select the transmission adaptor which connects the system whose system list you want to display.
- ② Select the range of the displayed refrigerant circuit. (*1)
- ③ When the button is clicked, the display data is refreshed.
- ④ The system list is automatically refreshed every 30 seconds by clicking Auto refresh .
- ⑤ Set whether Display item (column) should be displayed or hidden.
Items to be set in the option screen is as follows. When display items are set, they will be displayed on the right side.

Checked ...display, Unchecked ...hidden

Note *1 When "All Units" is selected, the entire refrigerant circuit is displayed.
i When "Ref No." is selected, a list of only the refrigerant circuit of the specified range is displayed. Specify the range of the refrigerant circuit you want to display.
Select the refrigerant circuit from . The refrigerant circuits currently registered are displayed.

5-5-3 System list printing

A print window of the currently displayed system list is displayed by clicking the **Print** button of the system list screen.

List area Header item

Address	Name	Model	Type	Capacity (BTU/h)	Operation	Mode	Set Temp (°C)	Room Temp (°C)	H.E.I. In (°C)	H.E.I. Mid (°C)	H.E.I. Out (°C)	EEV (P)	Error	Special Operation	Fan	V.T. Louver	H.Z. Louver	R.C. Prohibition	Time
00:31		Out	AJYA72LALH	Heat Pump	-	ON	Cool	-	-	-	-	0	Normal	-	Opn	-	-	-	16/10/2008 00:10:14 (S)
01:31		Out	AJYA90LALH	Heat Pump	-	ON	Cool	-	-	-	-	0	Normal	-	Opn	-	-	-	16/10/2008 00:10:14 (S)
02:32		Out	AJY103LALH	Heat Pump		ON	Cool					0	Normal		Opn				16/10/2008 00:10:11 (S)
00	00	In	AUXB07LALH	Compact Cassette	0	OFF	Step	-	20	20	20	20	0	Normal	-	-	-	OFF	16/10/2008 00:10:14 (S)
01		In	AUXB09LALH	Compact Cassette	0	OFF	Step	-	20	20	20	20	0	Normal	-	-	-	OFF	16/10/2008 00:10:14 (S)
02		In	AUXB12LALH	Compact Cassette	0	OFF	Step	-	20	20	20	20	0	Normal	-	-	-	OFF	16/10/2008 00:10:11 (S)
03		In	AUXB14LALH	Compact Cassette	0	OFF	Step	-	20	20	20	20	0	Normal	-	-	-	OFF	16/10/2008 00:10:14 (S)
04	02	In	AUXB18LALH	Compact Cassette	0	OFF	Step	-	20	20	20	20	0	Normal	-	-	-	OFF	16/10/2008 00:10:14 (S)
05		In	AUXB14LALH	Compact Cassette	0	OFF	Step	-	20	20	20	20	0	Normal	-	-	-	OFF	16/10/2008 00:10:14 (S)

1 Printer setup and printing

Click on the print tool icon on the right upper corner of the screen and select "Page Setup...".

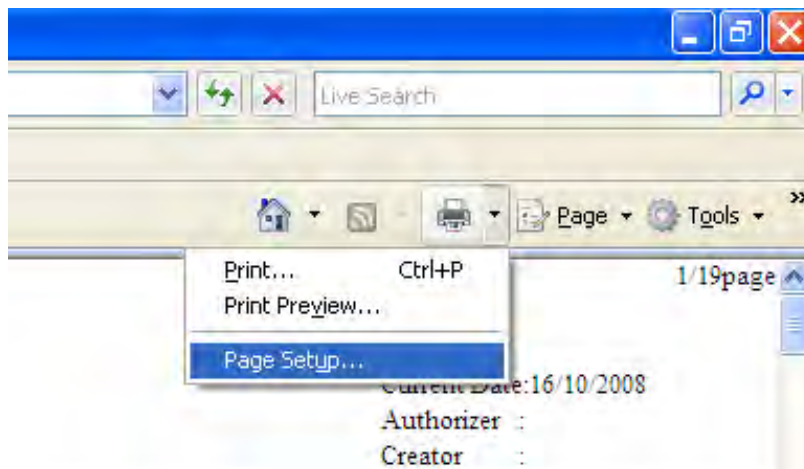

In the Page Setup screen, select the size of the paper as “A3” and the Orientation as “Landscape” and click “OK”. If other option is selected, the print may not come up as good.

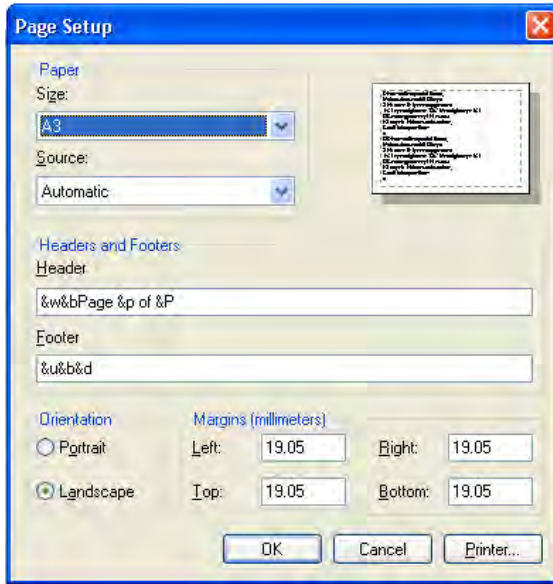

Click on the print tool icon on the right upper corner of the screen again and select “Print...” to start printing.

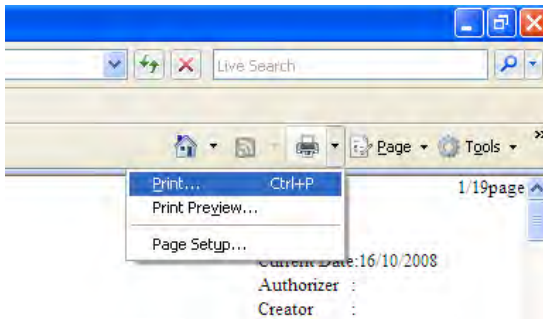

Note For Internet Explorer Ver.6 users, use the sub-menu in “File” menu to bring up the “Page Setup” screen and to perform “Print”.



Close button

When the  button is clicked, the print window closes.

Printing contents

Header item

Site	Displays the site name.
Adaptor	Displays the transmission adaptor name.
Ref No.	Displays the specified refrigerant circuit range.
Current Date	Displays the current date.

List area

List	Displays the system list displayed on the screen.
------	---

5-6 Detail screen (Diagram)

This screen displays the schematic, sensor values, and electrical components operating status of the selected system. At this screen, normal operation checks and cause specification when an error occurs are performed.

The schematic of 1 outdoor unit and 3 indoor units and 3 items graph can be simultaneously displayed.

Outdoor unit schematic diagram area

Control area

Indoor unit schematic area

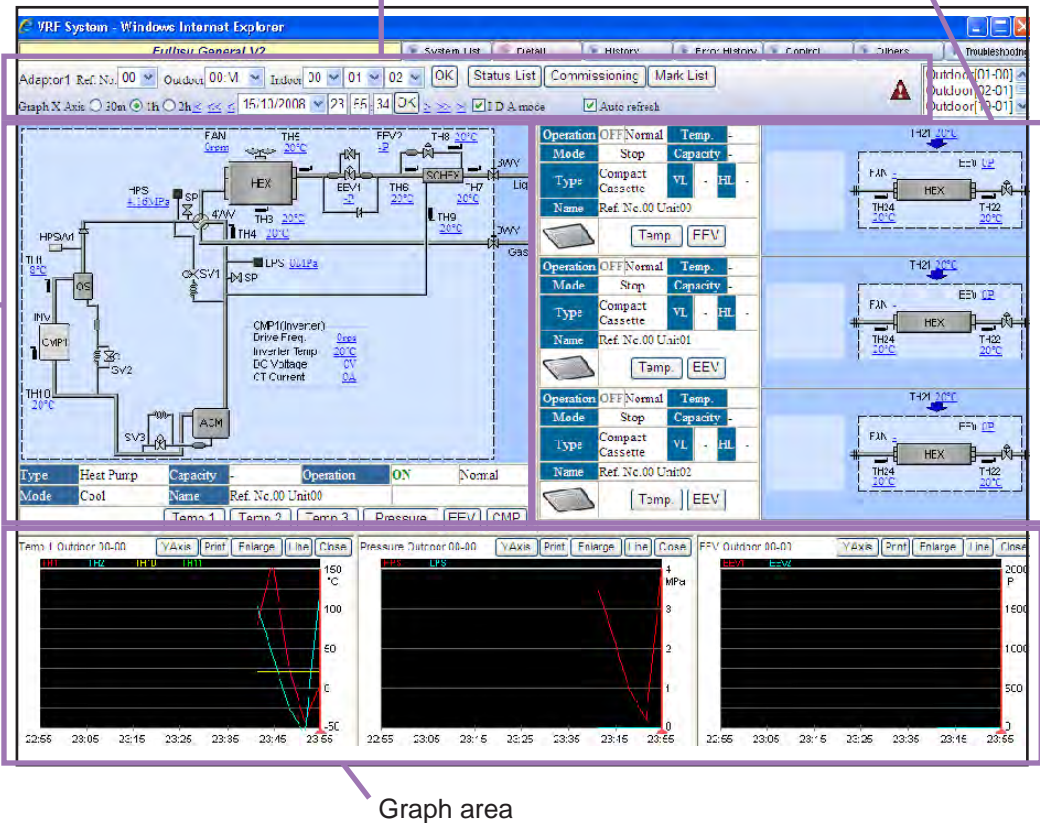

5-6-1 Name and function of each area

■ Control area

Sets display contents specification and automatic refresh on/off.

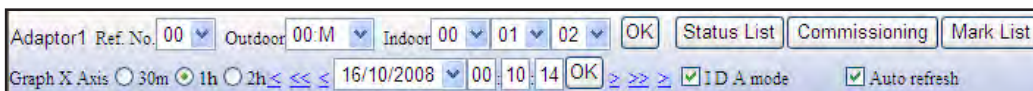

Ref. No.	Displays the refrigerant circuit address.
Outdoor	Specifies the outdoor unit No. displayed on the schematic.
Indoor	Specifies the indoor unit No. displayed on the schematic. (Up to 3 units can be specified.)
OK	The schematic of the specified unit is reflected on the screen by clicking this OK button after the refrigerant circuit address and unit No. were specified. (*1)

Commissioning	Starts the commissioning tool. (Refer to 5-8 Commissioning tool.) (*2)
Status List	Switch to the "Status List screen". (Refer to 5-7 Detail screen (Status List))
Mark List	Displays the list of abbreviations.
Graph X Axis	Specifies the X-axis scale of the graph.
<, <<, <	Moves the display time. (Refer to 5-6-2 Schematic specification method.)
Date	Specifies the date of the display data.
Time	Displays the acquisition time of the display data. (12-hour display or 24-hour display) (*3) For summer time, (S) is displayed. By inputting time, data for the nearest time will be displayed.
IDA mode	Sets to the Intensive Data Acquisition mode which demands data from the Web Monitoring Tool to each unit. (*4) The demand interval is set at 5-13-4 Demand interval setup. Checked: Demand output only for the displayed refrigerant circuit. Unchecked: Demand output for the entire system.
Auto refresh	Specifies automatic refreshing of the displayed data. Checked: Refresh screen automatically when refrigerant circuit status change. Unchecked: Do not automatically refresh the screen.

Note





- *1 When unchecked (no automatic refresh) at "Auto refresh", each time the OK button is clicked, the screen can be manually refreshed to the newest status.
- *2 Displayed only when Level 1 user was logged in by Server.
- *3 The display format depends on the setting at the data acquisition application. (Refer to 4-3 Environment setting.)
- *4 A data demand is sent from the Web Monitoring Tool at a fixed interval and the data returned by each unit in response to this demand is displayed on the screen.
When checked, since demands are limited to the displayed refrigerant circuits, detailed data collection is possible.
Conversely, a demand is not sent for refrigerant circuits other than the displayed systems. Select this when you want to monitor a specific refrigerant circuit.
When unchecked, demands are sent to the entire system. However, instead of the demand range becoming wide, the data density becomes thin. Set when the system is operating normally and you want to monitor the entire system.

Outdoor unit schematic area

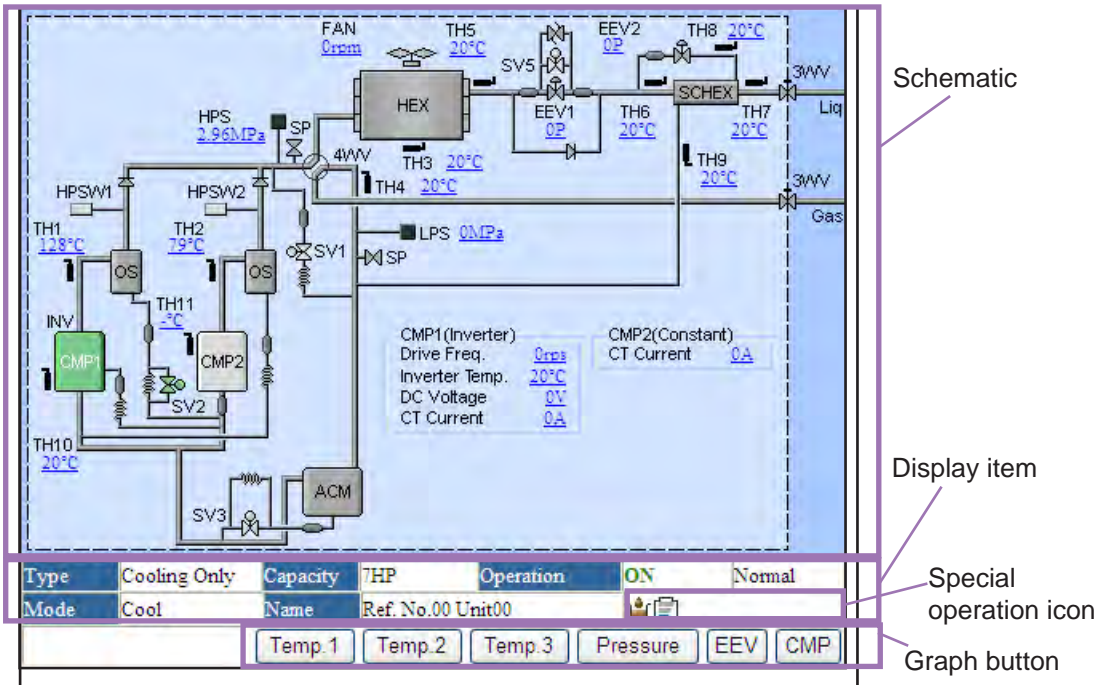
This area displays the outdoor unit schematic. For the meaning of each symbol, refer to the “Design & Technical Manual”. For the meaning of each item in the schematic, refer to the later schematic /graph display item.



Schematic

Schematic	Displays a schematic of the specified unit. • The schematic depends on the unit.
Compressor 	Displays the compressor status. On: Green Off: Gray
4-way valve/solenoid valve  	Displays the 4-way valve/solenoid valve status. On: Green Off: Gray *The outdoor unit of S series (VRF1/1A) does not change of status. (gray display)

Display items

Type	Displays the unit type.
Capacity	Displays the capacity of outdoor unit.
Operation	Displays the operating status (ON/OFF) and unit status (Normal/Error).
Mode	Displays the operating mode.
Name	Displays the unit name. (*1)
Special operation icon	Displays the special operation status using icon. Refer “List of icon for special operation” in P67.

Note *1 Only when preset (Refer to 3-2-4 Name master database file selection screen.)



Graph button

The graph corresponding to the clicked button is displayed. Up to 3 graphs can be displayed at the graph area. When you want to display a new graph, but 3 graphs are already displayed, close one of the graphs beforehand.

Temp.1	Displays discharge temperature graphs 1 ~ 3 at the graph area.
Temp.2	Displays the suction temperature and outdoor temperature graphs at the graph area.
Temp.3	Displays heat exchanger inlet/outlet temperature graphs 1 ~ 3 at the graph area.
Pressure	Displays a pressure graph at the graph area.
EEV	Displays an electrical expansion valve opening rate graph at the graph area.
CMP	Displays the operating status of the compressor at the graph area. For an inverter compressor, the operation frequency is also displayed.

Indoor unit schematic area

Displays the schematic of up to 3 indoor units selected by control area. For the meaning of each item in the schematic, refer to the later schematic/graph display item.

Display item

The screenshot shows a control interface for three indoor units. Each unit's data is presented in a table-like format with buttons for 'Temp.' and 'EEV'. To the right of each data block is a schematic diagram of the unit's internal components, including a HEX (heat exchanger), FAN, and EEV (electronic expansion valve). The units are labeled TH21, TH24, and TH22, all showing a temperature of 20°C. A 'Special operation icon' is shown below each schematic.

Display items

Operation	Displays the operating status (ON/OFF) and unit status (Normal/Error).
Mode	Displays the operating mode. (Refer to 5-5-1 Name and function of each area.)
Type	Displays the unit type.
Name	Displays the unit name. (*1)
Temp	Displays the setting temperature. Units display is [°C] or [°F]. (*2)
Capacity	Displays the capacity. Units display is [BTU/h] or [kW]. (*2)
VL	Displays the vertical louver position.
HL	Displays the horizontal louver position.
Indoor Unit Icon	Displays the status of the indoor units. The display color depends on the status. On: Green Off: Gray Test: Orange On (Error): Green Off (Error): Gray Test (Error): Orange.

Note *1 Only when preset. (Refer to 3-2-4 Name master database file selection screen.)

*2 The display format depends on the setting at the data acquisition application. (Refer to 4-3 Environment setting.)

Graph button

The graph corresponding to the clicked button is displayed. Up to 3 graphs can be displayed at the graph area. When you want to display a new graph, but 3 graphs are already displayed, close one of the graphs beforehand.

Temp	Displays a temperature graph at the graph area.
EEV	Displays an electrical expansion valve pulse value at the graph area.

Schematic

Schematic	Displays the schematic of the specified units. Up to 3 units can be displayed. The R.B. unit status will only be displayed beside the refrigerant circuit when the system type is heat recovery.
Special operation icon	Displays the special operation status using icon. Refer "List of icon for special operation in P67."

■ Graph area

Graphs are displayed by clicking each button of the control item from the indoor unit/outdoor unit schematic area.



Name	The graph item/unit name (if set) are displayed at the top left-hand corner of the graph area.
YAxis	Upper and lower limit of Y axis of the graph may arbitrary be set (*2). Allowable range for each graph types is as follows. <ul style="list-style-type: none"> • Temp: -75~185 °C/-122~398 °F • Pressure: 0~5 Mpa/0~730 psi • EEV: 0~2000 Pulse • CMP: 0~300 Hz
Print	Displays the print confirmation window. (*1)
Enlarge	Enlarges and displays a graph. (*1)
Line	Displays the graph line selection screen. (*1)
Close	Closes the graph.
Probe	The probe is moved to the left and right by dragging it with the mouse. The unit status received at the past time at the probe position is reflected on the schematic. When a past unit status is referenced, the "Auto refresh" check mark is automatically removed.

Note *1 For details, refer to the next clause (Graph area details).



*2 After upper and lower limit is set, scale for the Y axis will evenly be apportioned. Therefore, the scale may slightly be different from the actual value.

■ Graph area details

- Graphs can be printed by clicking the **Print** button.

- 1 OK button
Start printing by clicking the **OK** button.

Since a print confirmation screen is displayed, follow the instructions displayed on the screen. Set the printing form in the horizontal direction.

- 2 Cancel button
Close the print window without printing by clicking the **Cancel** button.

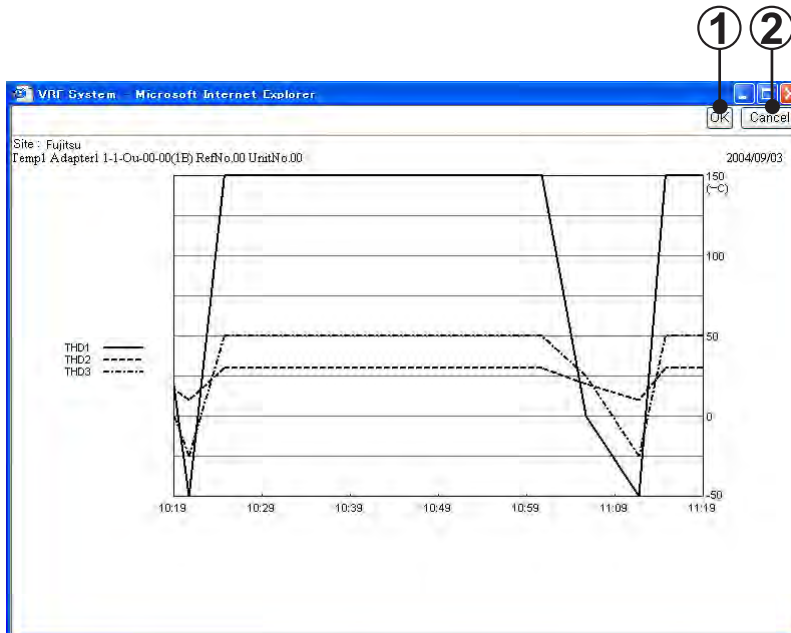

- The graph is vertically enlarged 2 times and displayed by clicking the **Enlarge** button.
- The graph line selection screen is displayed by clicking the **Line** button.
Graph display/hide can be set by checking/unchecking.
For the meaning of each item displayed on the graph line selection screen, refer to the later schematic/graph display item.

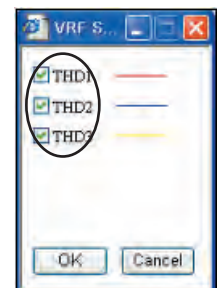

■ Schematic/graph display item

Shows the item names and contents displayed on the schematic and graph screens. The items in the graph button field can be graphically displayed with the graph button of the relevant name. However, there are also items which may not be displayed, depending on the unit series (S / V / VII / JII) and unit type (free / cooling only / heat pump).

- Outdoor unit

S	V	VII	JII	Graph button	Description
CMP1				CMP	Compressor 1
CMP2			—	CMP	Compressor 2
CMP3			—	CMP	Compressor 3
HEX				—	Heat exchanger
Fan			Fan1/Fan2	—	Outdoor fan
ACM				—	Accumulator
RCV			—	—	Receiver tank
OS				—	Oil separator
—	SCHEX			—	Sub cool heat exchanger
HPS				Pressure	High pressure sensor
MPS	—			Pressure	Middle pressure sensor
LPS				Pressure	Low pressure sensor
4WV1	4WV			—	4-way valve 1
4WV2	—			—	4-way valve 2
4WV3	—			—	4-way valve 3
4WV4	—			—	4-way valve 4
EEV1				EEV	Electrical expansion valve 1
EEV2				EEV	Electrical expansion valve 2
EEV3	—			EEV	Electrical expansion valve 3
—	SV1		—	—	Solenoid valve 1
—	SV2			—	Solenoid valve 2
—	SV3		—	—	Solenoid valve 3
—	SV4		—	—	Solenoid valve 4
—	SV5		—	—	Solenoid valve 5
—	SV6		—	—	Solenoid valve 6
—	SV7		—	—	Solenoid valve 7
—	SV8		—	—	Solenoid valve 8
THD1	TH1			Temp.1	Discharge temperature 1
THD2	TH2		—	Temp.1	Discharge temperature 2
THD3	TH3		—	Temp.1	Discharge temperature 3

THHI1	—	TH5		Temp.3/2	Heat exchanger inlet temperature 1 (S/V) Heat exchanger temperature (VII/JII)
THHI2	—			Temp.3	Heat exchanger inlet temperature 2
THHI3	—			Temp.3	Heat exchanger inlet temperature 3
THHO1	TH4	—		Temp.3/2	Heat exchanger outlet temperature 1
THHO2	—			Temp.3	Heat exchanger outlet temperature 2
THHO3	—			Temp.3	Heat exchanger outlet temperature 3
—	TH5	—		Temp.3	Receiver low level temperature
—	TH6	—		Temp.3	Receiver middle level temperature
—	TH7	—		Temp.3	Receiver high level temperature
—	TH8			Temp.3	SCHEX outlet temperature
—	TH9	TH6	—	Temp.2	Liquid temperature 1
—	TH10	TH7		Temp.2	Liquid temperature 2
THS	TH11	TH4		Temp.2/3	Suction temperature
THO	TH12	TH3		Temp.2	Outdoor temperature
—	TH13	TH9		Temp.3	SCHEX inlet temperature
—	—	TH10		Temp.1	Displays shell temperature (Inverter Comp.)
—	—	TH11	—	Temp.1	Displays shell temperature (Constant rate Comp.)
3WV			—	—	3-way valve
BV	—			—	Ball valve
SP			—	—	Service port
HP	—	HPSW1		—	High-pressure switch1
—	—	HPSW2	—	—	High-pressure switch2
LP	—			—	Low-pressure switch
—	Drive Freq.(Hz)	Drive Freq.(rps)		CMP	Displays drive frequency
—	Inverter Temp.(°C)			—	Displays IGBT temperature.
—	DC Voltage(V)			—	Displays DC voltage
—	CT Current(A)			—	Displays CT current

- Indoor unit

S	V	VII	Graph button	Description
EEV1	EEV		EEV	Electrical Expansion valve
MAX	—		—	Displays maximum EEV value.
THOA	—		Temp	Outlet temperature
THIA	TH21		Temp	Room temperature
THHI	TH22		Temp	Heat exchanger inlet temperature
THHM	TH23	—	Temp	Heat exchanger middle temperature
THHO	—	TH24	Temp	Heat exchanger outlet temperature
SVD	—		—	Discharge solenoid valve
SVS	—		—	Suction solenoid valve
SVB	—		—	Bypass solenoid valve

5-6-2 Schematic specification method

The refrigerant circuit, outdoor unit, and indoor unit are specified at the control area and the schematic is displayed. The graph X-axis/display date are also changed and the screen is refreshed.

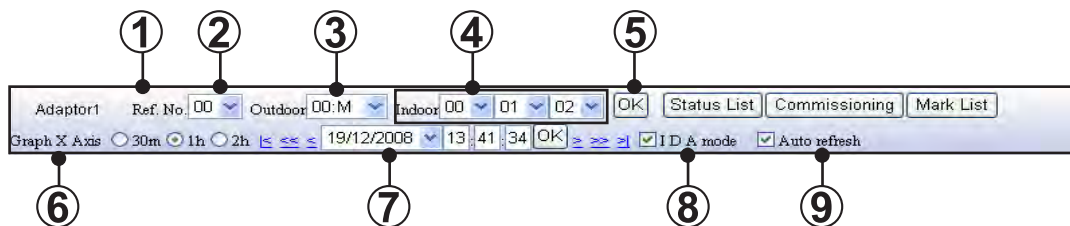

- ① Displays the transmission adaptor names. When you want to change the transmission adaptor, do it at the par. 5-5 System list screen.
- ② Specifies the refrigerant circuit.
- ③ Selects the outdoor unit.
- ④ Selects the indoor units. (Up to 3 indoor units can be selected.)
- ⑤ When the button is clicked, the schematic display is refreshed. (*1)
- ⑥ Changes the X-axis time. Select from 30m 1h 2h . (*2)
- ⑦ Displays the data of the specified date/time. (*3)
Select the date from .
Change the time by the following method.

<input type="button" value="← & →"/>	Shift the time 1 graduation.
<input type="button" value="←← & →→"/>	Shift the time 1 axis.
<input type="button" value="⏪ & ⏩"/>	Shift up to the first or last data acquisition time of the specified date.
<input type="text" value="02:58:24"/>	By inputting time, data for the nearest time will be displayed.

- ⑧ Demands are sent to the currently displayed refrigerant circuit in a concentrated manner by checking ID A mode . When you want to monitor units at a shorter interval, check mark the box.
- ⑨ Automatically refresh the screen at a 30 seconds interval by checking Auto refresh .

Note

- *1 The latest date/time are displayed. Only when preset.
- *2 The X-scale of the graph is changed by selection. (Default 1h)
- *3 The dates at which there is data are displayed in a list and can be selected. When the date/time was changed and the schematic was displayed, the check mark is removed from "Auto refresh".

5-7 Detail screen (Status List)

The Status List is started with the **Status List** button of the detail screen control area.

Status list screen will be switched from the diagram screen by clicking the “Status list” button in the detail screen area.

In this screen, detail data for all the units in the specified refrigerant circuit will be displayed at a certain point of time.

Control area

Outdoor unit status area

Indoor unit status area

5-7-1 Name and function of each area

■ Control area

Sets display contents specification.

The screenshot shows a control panel with the following elements:

- Adaptor1
- Ref. No. 00 with an OK button and an Option button.
- Buttons for Diagram, Commissioning, and Mark List.
- Date/Time: 19/12/2008, 13:44:52 with OK and navigation buttons.
- Checkboxes for IDA mode and Auto refresh.

Ref.No.	Displays the refrigerant circuit address. Also, any refrigerant circuit address may be specified and be switched to.
OK	Fix the Ref. No. and the date / time of the data to be displayed.
	Shift up to the first or last data acquisition time of the specified date.
	Shift the time 1 graduation.
Date/Time	Date/time for the data currently displayed will be shown. By specifying specific date and time, any data may be displayed.
Option	Set whether Display item (column) should be displayed or hidden. Items to be set in the option screen is as follows. When display items are set, they will be displayed on the right side. Checked ... display, Unchecked ... hidden
IDA mode	Sets to the Intensive Data acquisition mode which demands data from the Web Monitoring Tool to each unit. Checked: Demand output only for the displayed refrigerant circuit. Unchecked: Demand output for the entire system.
Auto refresh	Specifies automatic refreshing of the displayed data. Checked: Automatically refresh the screen at a 30 seconds interval. Unchecked: Do not automatically refresh the screen.
Diagram	This will switch to the Diagram screen. (Refer to 5-6 Detail screen (Diagram))
Commissioning	Starts the commissioning tool. (Refer to 5-8 Commissioning tool.)
Mark List	Displays the list of abbreviations.

■ Outdoor unit status area

Display the following operation status of each outdoor unit according to the condition given in the Control area.

Unit	Displays the unit No.
Name	Displays the unit name.
Type	Displays the unit type.
Operation	Displays the operating status (ON/OFF) and unit status (Normal/Error).
Special operation	Displays special operation.(*1)
Mode	Displays the operating mode.

* For other information, refer to the 5-5-1 Name and function of each area, Schematic/graph display item (Outdoor unit).

*1 For the meaning of the displayed icons, refer, icon list below

■ Indoor unit status area

Display the following operation status of each indoor unit according to the condition given in the Control area.







Unit	Displays the unit No.
Name	Displays the unit name.
Type	Displays the unit type.
Capacity	Displays the capacity. Units display is [BTU/h] or [kW].
Operation	Displays the operating status (ON/OFF) and unit status (Normal/Error).
Special operation	Displays special operation.(*1)
Mode	Displays the operating mode. (Refer to 5-5-1 Name and function of each area.)
Set Temp.	Displays the setting temperature. Units display is [°C] or [°F].
Fan	Displays the fan status.
V.T. Louver	Displays vertical louver position.
H.Z. Louver	Displays horizontal louver position.

* For other information, refer to the 5-5-1 Name and function of each area, Schematic/graph display item (Indoor unit).









*1 For the meaning of the displayed icons, refer, icon list below

■ List of icon for special operation

Outdoor unit

ICON	EXPLANATION
	Oil recovery operation
	Maintenance mode
	Emergency stop
	Outdoor unit stopped
	Defrost operation
	Night mode operation
	Power save operation

Indoor unit

ICON	EXPLANATION
	Freeze prevention operation
	Anti-freeze operation
	Anti-freeze setting
	Maintenance mode
	Master indoor unit
	Operation mode controlled by master outdoor unit
	Operation mode controlled by master indoor unit
	Emergency stop
	Energy save operation

5-8 Commissioning tool

The commissioning tool is started with the  button of the detail screen control area.

The commissioning tool can operate only when a Level 1 user was logged in by Server. In other cases, the button is not displayed at the detail screen control part. (Refer to par. 5-6-1.)

Test run commands can be executed with the commissioning tool. During test running, the outdoor unit/indoor unit sensor data can be saved (commissioning log data). After the end of test running, this data can be exported in CSV file format.

The exported CSV file can be used in commissioning report generation by reading the CSV file by Excel or other spreadsheet application.

The commissioning screen is automatically refreshed and the latest status is displayed every 30 seconds.

5-8-1 Name and function of each area

■ Control area (initial display)

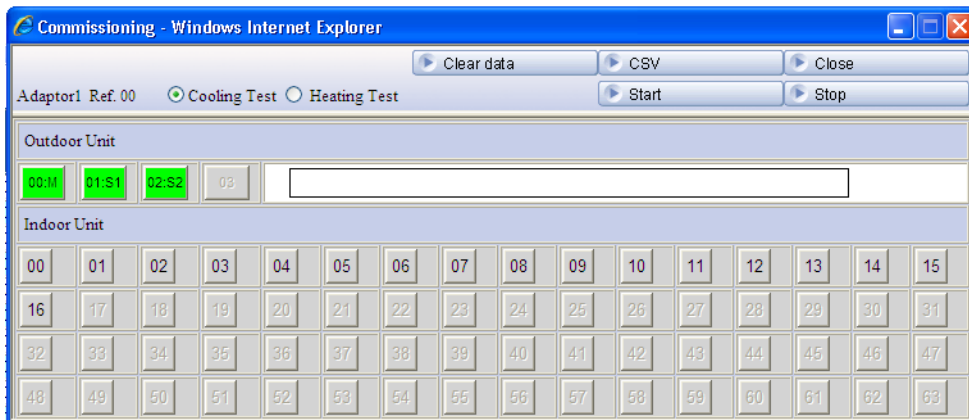

Ref No.	Displays the refrigerant circuit address.
Test Pattern Select	Selects "Cooling Test" / "Heating Test" . When selection is switched, unit button selections are all reset.
Clear data	Clears all the commissioning log data of the displayed refrigerant circuit.
CSV	Creates the commissioning log data to an arbitrary file as a CSV file.
Close	Closes the commissioning tool screen. Test running is not stopped at exiting.
Stop	Executes a stop command for all the indoor units of the relevant refrigerant circuit.
Start	Executes the test run command for the selected unit. After the Start button was clicked, unit button selection cannot be changed. If there is even 1 indoor unit currently being operated by control, etc. from another unit, test run commands cannot be executed. Use the Stop button and stop all the units in advance.

Unit Name Display Area	When a unit name is registered, and the mouse cursor is aligned with the unit button, that unit name is displayed. (Only when set)
Unit Button (outdoor unit)	Represents the current status by character color and back ground color. (*1) When 1 outdoor unit button is selected, other outdoor unit buttons can be simultaneously selected.
Unit Button (indoor unit)	Represents the current status by character color and back ground color. (*1) Multiple indoor unit buttons can be simultaneously selected.
Commissioning Log Data Yes/No Display Area	Displays whether or not there is commissioning log data for each unit. (*2)

Note *1 Unit button display status (indoor unit/outdoor unit)



Display		Status
	Character color (black)	Unselected state
	Character color (Red: Bold & italic)	Selected state
	Button color (green)	(Indoor unit) Running (Outdoor unit) Unit running or thermostat on
	Button color (gray)	(Indoor unit) Stopped (Outdoor unit) Unit stopped or thermostat off

*2 Commissioning log data yes/no display status

Display		Status
	Background color (blue)	Commissioning log data of the unit of the currently selected test pattern.
	Background color (gray)	No commissioning log data of unit of the currently selected test pattern

■ Control area (after run command)

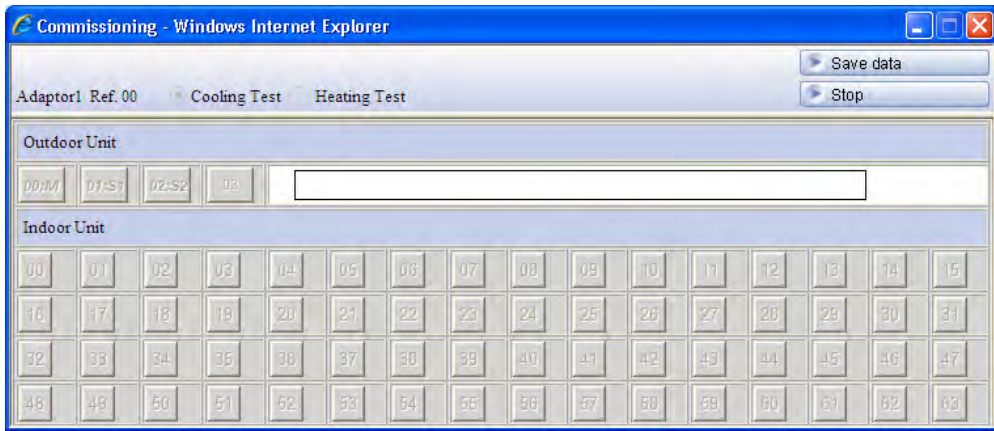

Save data	Saves the sensor data of the test running unit to the commissioning log data. The commissioning log data is saved for each Test Pattern.
Stop	Stops test running of the relevant refrigerant circuit and returns to the initial display.
Unit Button	After run command, enters the unselectable state. For units which performed a test run, the button color is displayed in green.

5-8-2 Operating procedure

Selects the test items and the units to be tested from all the units stopped status.

- 1 Check the refrigerant circuit address to which the units which are to be test run at “Ref.” on the screen.
Since the refrigerant circuit address specified at the detail screen is displayed here, when making changes, after re-specifying by 5-6 Detail screen and clicking the OK button, start the commissioning tool.
- 2 Select the test pattern according to the item to be test run.
For test run by cooling, select “Cooling Test” and for test run by heating, select “Heating Test”.

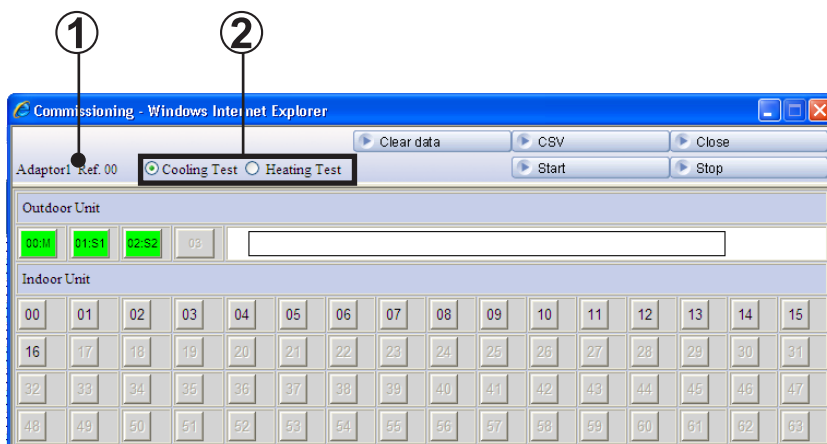

- 3 Select the unit which is to start test run. Select the unit by clicking the button of the relevant unit No.

The selected unit is displayed by a red italic numeric.

For outdoor units, when any button is selected, all the indoor units also enter the selected state. For indoor units, when any button is selected, all the units that belong to the same R.C. group as the selected unit No. also enter the selected state.

- 4 When the button is clicked in the units selected state, test run is started.

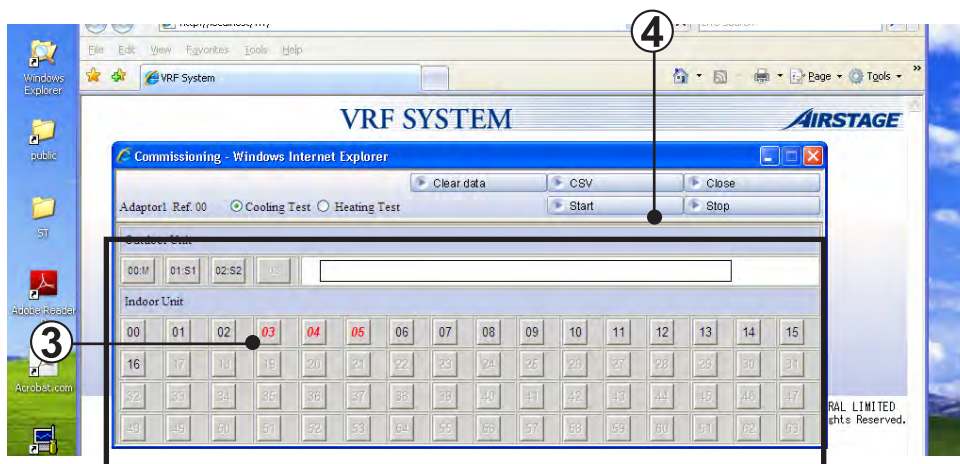

- ⑤ The button of units that have entered the test run state is displayed in green. When an indoor unit was selected and started, the selected indoor units enter the test run state. When an outdoor unit was selected and started, all the indoor units enter the test run state.

After test run starts, new test run objective units cannot be added. Perform test run stop of ⑦, clear the commissioning log data of ⑨, as required, and repeat operation from the initial state.

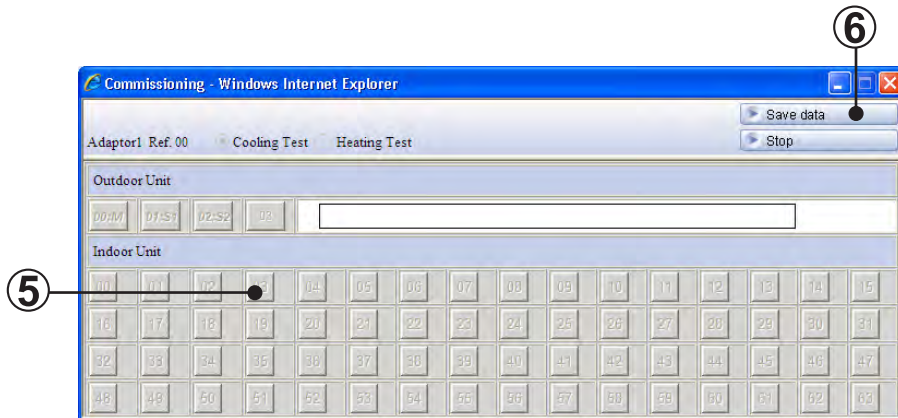

- ⑥ The commissioning log data of the selected units (italic bold characters) is saved by clicking the button. On the screen, the background color of the unit No. that generated the commissioning log data changes to blue.

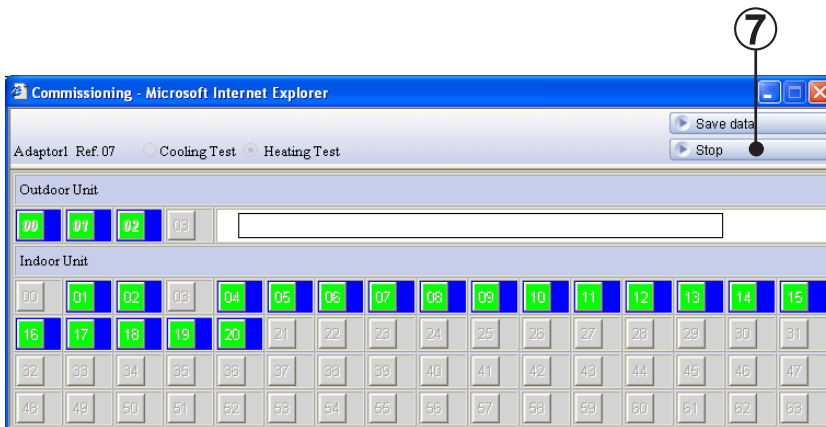

- ⑦ Test run can be stopped by clicking the button. The display returns to the initial screen, but the commissioning log data cannot be cleared. (The background color of the unit Nos. at which there is commissioning log data remains blue.)

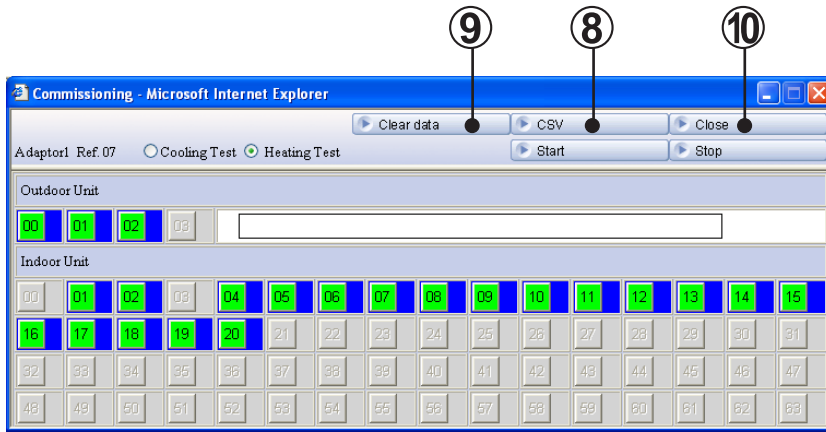

- ⑧ A CSV file for generating a commissioning report can be saved to an arbitrary folder by clicking the button in the state of the unit which generated the commissioning log data. (For the commissioning report generation method, refer to 5-8-3 Commissioning report generation.)
- ⑨ The commissioning log data can be cleared by clicking the button. When the commissioning log data is cleared, the background color returns to gray.
- ⑩ End the commissioning tool by clicking the button. However, units which are test running are not stopped.

5-8-3 Commissioning report generation

There is a template to easily generate a commissioning report. (*1)

A commissioning report can be easily generated by reading the CSV file generated by the commissioning tool to this template.

- ① Since there is a template named “CommissioningReport.xls” at C:\Program Files\VRF System\Web Monitoring Tool, open that file with Excel. (*1)
- ② Display the started Excel “Creation” sheet.
A screen like that shown below is displayed. (*2)

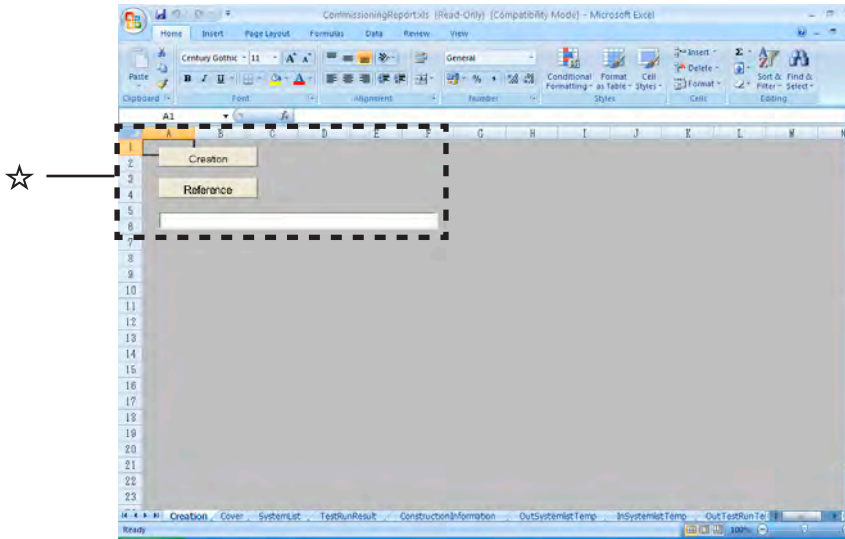

Overview of each sheet

Creation	This screen is used to specify the read CSV file and execute commissioning report generation.
Cover	Commissioning report cover (*3)
SystemList	System list
TestRunResult	Test run result
ConstructionInformation	Construction information (*3)
OutSystemListTemp	System list template (outdoor unit)
InSystemListTemp	System list template (indoor unit)
OutTestRunTemp	Test run result template (outdoor unit)
InTestRunTemp	Test run result template (indoor unit)
DataSheet	Temporarily saves the CSV data. This sheet is used in report generation processing.

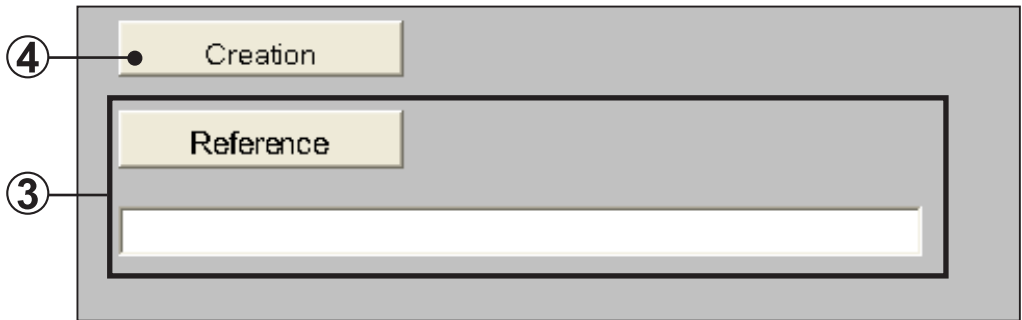

- ③ Specify the read CSV file by full path.
A file reference dialog box is displayed by clicking the **Reference** button.
When a file other than a CSV file created by commissioning tool was specified when the path is incorrect, a commissioning report is not generated.
Specify the correct file.
- ④ Create “SystemList” and “TestRunResult” which read the CSV file specified at ③ by clicking the **Creation** button.

Note



- *1 This template is created by Excel spreadsheet program.
Excel must be purchased separately.
When opening the file, you may be asked if you want to enable macro, depending on the security level set within Excel. In such cases, select “Enable Macros”.
- *2 When you want to change the displayed sheet, click the sheet heading at the bottom of the screen. (See the following figure.)

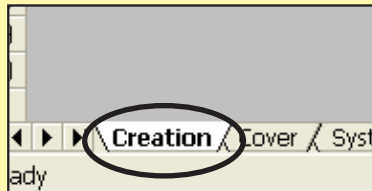

- *3 Since generation is not automatic, the necessary items are inputted manually.

5-9 Operation history screen

The indoor units or outdoor unit operation history is displayed for each unit.

The displayed operation history can be printed and saved to a CSV file.

History display can display up to 500 items for the specified period.

5-9-1 Name and function of each area

■ Control area (common)

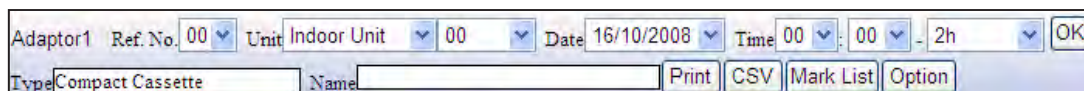

Adaptor1 Ref. No. 00 Unit Indoor Unit 00 Date 16/10/2008 Time 00:00 - 2h OK
Type Compact Cassette Name Print CSV Mark List Option

Adaptor	Specifies the transmission adaptor.
Ref. No.	Specifies the refrigerant circuit address.
Unit	Switches outdoor unit/indoor unit and selects the unit No.
Date	Specifies the date of the history data to be displayed.
Time	Specify the time range of the history data to be displayed.
OK	Displays the data of the unit of the specified conditions.
Type	Displays the unit type.
Capacity	Displays the capacity of outdoor unit.
Name	Displays the unit name.
Print	Displays a print window.
CSV	Displays the CSV save window.
Mark List	Displays the list of abbreviations.
Option	Set whether Display item (column) should be displayed or hidden.

Outdoor unit

The screenshot shows a software window titled 'VRF System' with a menu bar and a toolbar. Below is a data table with the following columns: Time, Operation, Special Operation, Mode, TH1 (°C), TH2 (°C), TH3 (°C), TH4 (°C), TH5 (°C), TH6 (°C), TH7 (°C), TH8 (°C), TH9 (°C), TH10 (°C), TH11 (°C), TH12 (°C), LPR (0.0Pa), LRV (0.0Pa), LRV1, and LRV2. The table contains multiple rows of data, with one row highlighted in purple. A red arrow points to this row from the label 'Display item'. At the bottom, a purple box highlights the navigation area with the label 'Page area'.

Display item





Page area

- Display item

S	V	VII	JII	Description
Time				Displays the data acquisition time. (*1) For summer time, (S) is displayed.
Operation				Displays the operating status/unit status
—	Special operation			Displays special operation in icon. Refer "Icon list for special operation".
Mode				Displays the operating mode
THD1	TH1			Displays discharge temperature 1. (*2)
THD2	TH2		—	Displays discharge temperature 2. (*2)
THD3	TH3	—		Displays discharge temperature 3. (*2)
THH1	—	TH5		Displays heat exchanger inlet temperature 1. (S/V) Displays heat exchange temperature (VII/JII). (*2)
THH2	—			Displays heat exchanger inlet temperature 2. (*2)
THH3	—			Displays heat exchanger inlet temperature 3. (*2)
THH01	TH4	—		Displays heat exchanger outlet temperature 1. (*2)
THH02	—			Displays heat exchanger outlet temperature 2. (*2)
THH03	—			Displays heat exchanger outlet temperature 3. (*2)
—	TH5	—		Displays receiver low level temperature. (*2)
—	TH6	—		Displays receiver middle level temperature. (*2)
—	TH7	—		Displays receiver high level temperature. (*2)
—	TH8			Displays the SC HEX outlet temperature. (*2)
—	TH9	TH6	—	Displays liquid temperature 1. (*2)
—	TH10	TH7		Displays liquid temperature 2. (*2)
THS	TH11	TH4		Displays the suction temperature. (*2)
THO	TH12	TH3		Displays the outdoor temperature. (*2)

—	TH13	TH9		Displays the SCHEX inlet temperature. (*2)
—	—	TH10		Displays shell temperature (Inverter comp.)
—	—	TH11	—	Displays shell temperature (Constant rate comp.)
HPS				Displays high pressure. (*3)
LPS				Displays low pressure. (*3)
MPS	—			Displays middle pressure. (*3)
—	4WV			Displays 4-way valve status.
—	SV1		—	Displays solenoid valve 1 status.
—	SV2			Displays solenoid valve 2 status.
—	SV3		—	Displays solenoid valve 3 status.
—	SV4	—		Displays solenoid valve 4 status.
—	SV5		—	Displays solenoid valve 5 status.
—	SV6		—	Displays solenoid valve 6 status.
—	SV7	—		Displays solenoid valve 7 status.
—	SV8	—		Displays solenoid valve 8 status.
CMP1				Displays compressor 1 status.
CMP2			—	Displays compressor 2 status.
CMP3		—		Displays compressor 3 status.
—	HPSW1			Displays high pressure switch 1
—	HPSW2	—		Displays high pressure switch 2
Fan			Fan1/Fan2	Displays the fan status.
EEV1				Displays electrical expansion valve 1 status.
EEV2				Displays electrical expansion valve 2 status.
EEV3	—			Displays electrical expansion valve 3 status.
—	Inverter CMP (Hz)	Inverter CMP (rps)		Displays drive frequency of inverter comp.
—	Inverter CMP (°C)			Displays IGBT temperature of inverter comp.
—	Inverter CMP (V)			Displays DC voltage of inverter comp.
—	Inverter CMP (A)			Displays CT current of inverter comp.
—	CT current		—	Displays CT current of constant rate comp.

- Page area
Page will be displayed, if number of items to be displayed exceeds 1 page.
(Refer to 5-14 Others screen (Display setting))

 & 	Page may be shifted back and forth every 10 page.
 & 	Signifies that there are no more page.
Page No.	Displays data corresponding to the page.

- Note** 
- *1 12-hour or 24-hour display. The display format depends on the setting at the data acquisition application.
 - *2 Units display is [°C] or [°F]. The display format depends on the setting at the data acquisition application.
 - *3 Units display is [Mpa] or [psi]. The display format depends on the setting at the data acquisition application.
 - * For setting at the data acquisition application, refer to 4-3 Environment setting.

■ Indoor unit

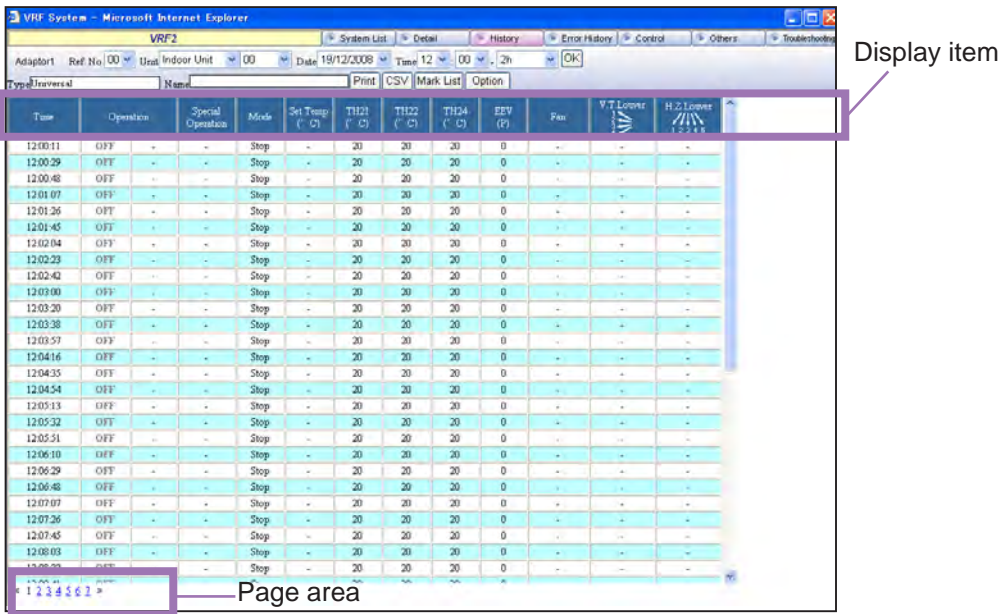



- Display item

S	V	VII	Description
Time			Displays the data acquisition time. (*1) For summer time, (S) is displayed.
Operation			Displays the operating status/unit status.
—		Special operation	Displays special operation.
Mode			Displays the operating mode. (Refer to 5-5-1 Name and function of each area.)
Set Temp			Displays the setting temperature. (*2)
THIA	TH21		Displays the room temperature. (*2)
THHI	TH22		Displays heat exchanger inlet temperature. (*2)
THHM	TH23	—	Displays the heat exchanger middle temperature. (*2)
—	TH24		
THHO	—		Displays the heat exchanger outlet temperature. (*2)
THOA	—		Displays the outlet temperature. (*2)
EEV			Displays electrical expansion valve status.
MAX EEV	—		Displays maximum EEV value.
SVD	—		Displays discharge solenoid valve status.
SVS	—		Displays suction solenoid valve status.
SVB	—		Displays bypass solenoid valve status.
—	Fan		Displays fan volume.
—	V.T. Louver		Displays vertical fan position.
—	H.Z. Louver		Displays horizontal fan position.

- Page area







Page will be displayed, if number of items to be displayed exceeds 1 page.
(Refer to 5-14 Others screen (Display setting))

	Page may be shifted back and forth every 10 page.
	Signifies that there are no more page.
Page No.	Displays data corresponding to the page.









- Note**  *4 12-hour or 24-hour display. The display format depends on the setting at the data acquisition application.
- *5 Units display is [°C] or [°F]. The display format depends on the setting at the data acquisition application.
- * For setting at the data acquisition application, refer to 4-3 Environment setting.

■ List of icon for special operation

Outdoor unit

ICON	EXPLANATION
	Oil recovery operation
	Maintenance mode
	Emergency stop
	Outdoor unit stopped
	Defrost operation
	Night mode operation
	Power save operation

Indoor unit

ICON	EXPLANATION
	Freeze prevention operation
	Anti-freeze operation
	Anti-freeze setting
	Maintenance mode
	Master indoor unit
	Operation mode controlled by master outdoor unit
	Operation mode controlled by master indoor unit
	Emergency stop
	Energy save operation

5-9-2 Operation history specification

- ①** Transmission adaptor display field
The selected transmission adaptor is displayed on the par. 5-5 System list screen. When you want to change the transmission adaptor, do it from the par. 5-5 System list screen.
- ②** Refrigerant circuit selection field
Specifies the refrigerant circuit address.
- ③** Unit selection field
Switches the unit to be displayed. (Select from “Indoor Unit” / “Outdoor Unit”.)
- ④** Date specification field
Specifies the date of the history data to be displayed.
- ⑤** Display time range specification field
Specifies the range of the history time to be displayed.

* By specifying “1 day”, the range will be 24 hours from the starting time. If range other than “1 day” is specified, only data for that day (till midnight) will be displayed.
- ⑥** OK button
Displays the history by specified condition.
- ⑦** Print button
Prints the displayed data.
- ⑧** CSV button
Displays the CSV save widow.
- ⑨** Set whether Display item (column) should be displayed or hidden.
Items to be set in the option screen is as follows. When display items are set, they will be displayed on the right side.

Checked ... display, Unchecked ... hidden

Note For Windows®XP SP2 and later versions,
i in order to save CSV files, set Internet Explorer as follows;
from [Tool] menu, select [Pop-up Blocker], [Turn Off Pop-up Blocker]

5-9-3 Operation history printing

The operation history currently being displayed can be printed by clicking the  button.

- 1 Printer setup and printing
Click on the print tool icon on the right upper corner of the screen and select “Page Setup...”.

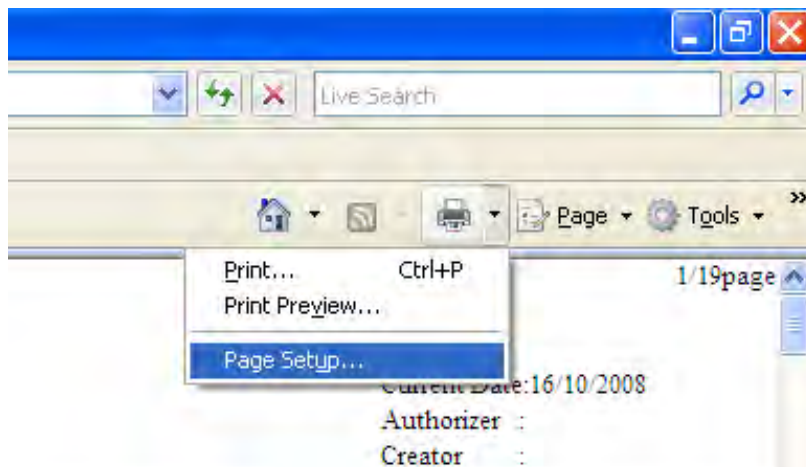

In the Page Setup screen, select the size of the paper as “A3” and the Orientation as “Landscape” and click “OK”. If other option is selected, the print may not come up as good.

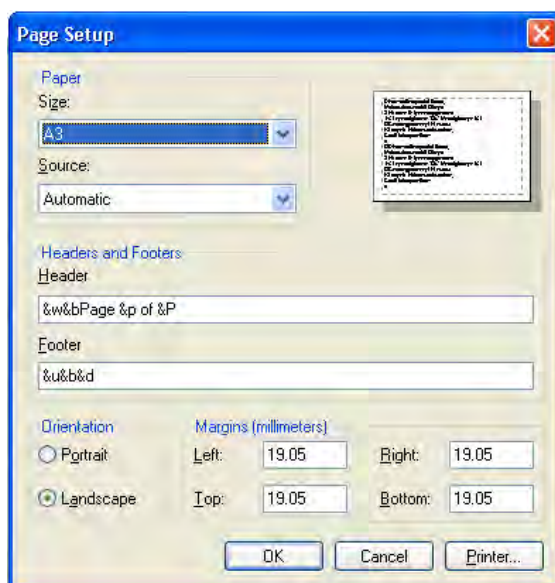

Click on the print tool icon on the right upper corner of the screen again and select "Print..." to start printing.

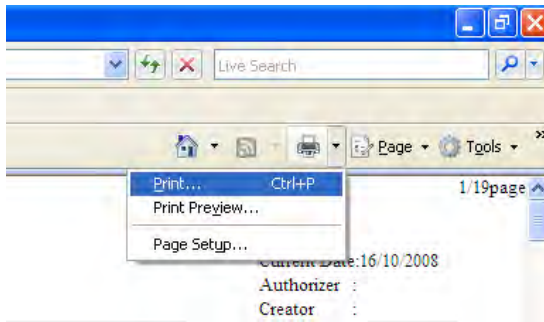

Note For Internet Explorer Ver.6 users, use the sub-menu in "File" menu to bring up the "Page Setup" screen and to perform "Print".

2 Close button
When the button is clicked, the print window closes.

1 Header

2 List

***** Operation History (Outdoor Unit) *****

Site : Fujitsu General V2
 Adaptor : Acaptor1 Ref.No. : 100 Lmt.No. : 100M
 Type : Heat Pump Capacity : HP
 Name :
 16.10.2008 09:00 - 02:00
 Current Date : 16.10.2008
 Authorizer :
 Creator :

Time	Operator	Special Operation	Mode	TH1 (°C)	TH2 (°C)	TH3 (°C)	TH4 (°C)	TH5 (°C)	TH6 (°C)	TH7 (°C)	TH8 (°C)	TH9 (°C)	TH10 (°C)	TH11 (°C)	HDR (GPa)	TSR (GPa)	4W	SV1	SV2	SV3	SV4	SV5	SV6	SV7	SV8	SV9	SV10	SV11	SV12	SV13	SV14	SV15	SV16	SV17	SV18	SV19	SV20	SV21	SV22	SV23	SV24	SV25	SV26	SV27	SV28	SV29	SV30	SV31	SV32	SV33	SV34	SV35	SV36	SV37	SV38	SV39	SV40	SV41	SV42	SV43	SV44	SV45	SV46	SV47	SV48	SV49	SV50	SV51	SV52	SV53	SV54	SV55	SV56	SV57	SV58	SV59	SV60	SV61	SV62	SV63	SV64	SV65	SV66	SV67	SV68	SV69	SV70	SV71	SV72	SV73	SV74	SV75	SV76	SV77	SV78	SV79	SV80	SV81	SV82	SV83	SV84	SV85	SV86	SV87	SV88	SV89	SV90	SV91	SV92	SV93	SV94	SV95	SV96	SV97	SV98	SV99	SV100	SV101	SV102	SV103	SV104	SV105	SV106	SV107	SV108	SV109	SV110	SV111	SV112	SV113	SV114	SV115	SV116	SV117	SV118	SV119	SV120	SV121	SV122	SV123	SV124	SV125	SV126	SV127	SV128	SV129	SV130	SV131	SV132	SV133	SV134	SV135	SV136	SV137	SV138	SV139	SV140	SV141	SV142	SV143	SV144	SV145	SV146	SV147	SV148	SV149	SV150	SV151	SV152	SV153	SV154	SV155	SV156	SV157	SV158	SV159	SV160	SV161	SV162	SV163	SV164	SV165	SV166	SV167	SV168	SV169	SV170	SV171	SV172	SV173	SV174	SV175	SV176	SV177	SV178	SV179	SV180	SV181	SV182	SV183	SV184	SV185	SV186	SV187	SV188	SV189	SV190	SV191	SV192	SV193	SV194	SV195	SV196	SV197	SV198	SV199	SV200	SV201	SV202	SV203	SV204	SV205	SV206	SV207	SV208	SV209	SV210	SV211	SV212	SV213	SV214	SV215	SV216	SV217	SV218	SV219	SV220	SV221	SV222	SV223	SV224	SV225	SV226	SV227	SV228	SV229	SV230	SV231	SV232	SV233	SV234	SV235	SV236	SV237	SV238	SV239	SV240	SV241	SV242	SV243	SV244	SV245	SV246	SV247	SV248	SV249	SV250	SV251	SV252	SV253	SV254	SV255	SV256	SV257	SV258	SV259	SV260	SV261	SV262	SV263	SV264	SV265	SV266	SV267	SV268	SV269	SV270	SV271	SV272	SV273	SV274	SV275	SV276	SV277	SV278	SV279	SV280	SV281	SV282	SV283	SV284	SV285	SV286	SV287	SV288	SV289	SV290	SV291	SV292	SV293	SV294	SV295	SV296	SV297	SV298	SV299	SV300	SV301	SV302	SV303	SV304	SV305	SV306	SV307	SV308	SV309	SV310	SV311	SV312	SV313	SV314	SV315	SV316	SV317	SV318	SV319	SV320	SV321	SV322	SV323	SV324	SV325	SV326	SV327	SV328	SV329	SV330	SV331	SV332	SV333	SV334	SV335	SV336	SV337	SV338	SV339	SV340	SV341	SV342	SV343	SV344	SV345	SV346	SV347	SV348	SV349	SV350	SV351	SV352	SV353	SV354	SV355	SV356	SV357	SV358	SV359	SV360	SV361	SV362	SV363	SV364	SV365	SV366	SV367	SV368	SV369	SV370	SV371	SV372	SV373	SV374	SV375	SV376	SV377	SV378	SV379	SV380	SV381	SV382	SV383	SV384	SV385	SV386	SV387	SV388	SV389	SV390	SV391	SV392	SV393	SV394	SV395	SV396	SV397	SV398	SV399	SV400	SV401	SV402	SV403	SV404	SV405	SV406	SV407	SV408	SV409	SV410	SV411	SV412	SV413	SV414	SV415	SV416	SV417	SV418	SV419	SV420	SV421	SV422	SV423	SV424	SV425	SV426	SV427	SV428	SV429	SV430	SV431	SV432	SV433	SV434	SV435	SV436	SV437	SV438	SV439	SV440	SV441	SV442	SV443	SV444	SV445	SV446	SV447	SV448	SV449	SV450	SV451	SV452	SV453	SV454	SV455	SV456	SV457	SV458	SV459	SV460	SV461	SV462	SV463	SV464	SV465	SV466	SV467	SV468	SV469	SV470	SV471	SV472	SV473	SV474	SV475	SV476	SV477	SV478	SV479	SV480	SV481	SV482	SV483	SV484	SV485	SV486	SV487	SV488	SV489	SV490	SV491	SV492	SV493	SV494	SV495	SV496	SV497	SV498	SV499	SV500	SV501	SV502	SV503	SV504	SV505	SV506	SV507	SV508	SV509	SV510	SV511	SV512	SV513	SV514	SV515	SV516	SV517	SV518	SV519	SV520	SV521	SV522	SV523	SV524	SV525	SV526	SV527	SV528	SV529	SV530	SV531	SV532	SV533	SV534	SV535	SV536	SV537	SV538	SV539	SV540	SV541	SV542	SV543	SV544	SV545	SV546	SV547	SV548	SV549	SV550	SV551	SV552	SV553	SV554	SV555	SV556	SV557	SV558	SV559	SV560	SV561	SV562	SV563	SV564	SV565	SV566	SV567	SV568	SV569	SV570	SV571	SV572	SV573	SV574	SV575	SV576	SV577	SV578	SV579	SV580	SV581	SV582	SV583	SV584	SV585	SV586	SV587	SV588	SV589	SV590	SV591	SV592	SV593	SV594	SV595	SV596	SV597	SV598	SV599	SV600	SV601	SV602	SV603	SV604	SV605	SV606	SV607	SV608	SV609	SV610	SV611	SV612	SV613	SV614	SV615	SV616	SV617	SV618	SV619	SV620	SV621	SV622	SV623	SV624	SV625	SV626	SV627	SV628	SV629	SV630	SV631	SV632	SV633	SV634	SV635	SV636	SV637	SV638	SV639	SV640	SV641	SV642	SV643	SV644	SV645	SV646	SV647	SV648	SV649	SV650	SV651	SV652	SV653	SV654	SV655	SV656	SV657	SV658	SV659	SV660	SV661	SV662	SV663	SV664	SV665	SV666	SV667	SV668	SV669	SV670	SV671	SV672	SV673	SV674	SV675	SV676	SV677	SV678	SV679	SV680	SV681	SV682	SV683	SV684	SV685	SV686	SV687	SV688	SV689	SV690	SV691	SV692	SV693	SV694	SV695	SV696	SV697	SV698	SV699	SV700	SV701	SV702	SV703	SV704	SV705	SV706	SV707	SV708	SV709	SV710	SV711	SV712	SV713	SV714	SV715	SV716	SV717	SV718	SV719	SV720	SV721	SV722	SV723	SV724	SV725	SV726	SV727	SV728	SV729	SV730	SV731	SV732	SV733	SV734	SV735	SV736	SV737	SV738	SV739	SV740	SV741	SV742	SV743	SV744	SV745	SV746	SV747	SV748	SV749	SV750	SV751	SV752	SV753	SV754	SV755	SV756	SV757	SV758	SV759	SV760	SV761	SV762	SV763	SV764	SV765	SV766	SV767	SV768	SV769	SV770	SV771	SV772	SV773	SV774	SV775	SV776	SV777	SV778	SV779	SV780	SV781	SV782	SV783	SV784	SV785	SV786	SV787	SV788	SV789	SV790	SV791	SV792	SV793	SV794	SV795	SV796	SV797	SV798	SV799	SV800	SV801	SV802	SV803	SV804	SV805	SV806	SV807	SV808	SV809	SV810	SV811	SV812	SV813	SV814	SV815	SV816	SV817	SV818	SV819	SV820	SV821	SV822	SV823	SV824	SV825	SV826	SV827	SV828	SV829	SV830	SV831	SV832	SV833	SV834	SV835	SV836	SV837	SV838	SV839	SV840	SV841	SV842	SV843	SV844	SV845	SV846	SV847	SV848	SV849	SV850	SV851	SV852	SV853	SV854	SV855	SV856	SV857	SV858	SV859	SV860	SV861	SV862	SV863	SV864	SV865	SV866	SV867	SV868	SV869	SV870	SV871	SV872	SV873	SV874	SV875	SV876	SV877	SV878	SV879	SV880	SV881	SV882	SV883	SV884	SV885	SV886	SV887	SV888	SV889	SV890	SV891	SV892	SV893	SV894	SV895	SV896	SV897	SV898	SV899	SV900	SV901	SV902	SV903	SV904	SV905	SV906	SV907	SV908	SV909	SV910	SV911	SV912	SV913	SV914	SV915	SV916	SV917	SV918	SV919	SV920	SV921	SV922	SV923	SV924	SV925	SV926	SV927	SV928	SV929	SV930	SV931	SV932	SV933	SV934	SV935	SV936	SV937	SV938	SV939	SV940	SV941	SV942	SV943	SV944	SV945	SV946	SV947	SV948	SV949	SV950	SV951	SV952	SV953	SV954	SV955	SV956	SV957	SV958	SV959	SV960	SV961	SV962	SV963	SV964	SV965	SV966	SV967	SV968	SV969	SV970	SV971	SV972	SV973	SV974	SV975	SV976	SV977	SV978	SV979	SV980	SV981	SV982	SV983	SV984	SV985	SV986	SV987	SV988	SV989	SV990	SV991	SV992	SV993	SV994	SV995	SV996	SV997	SV998	SV999	SV1000
------	----------	-------------------	------	----------	----------	----------	----------	----------	----------	----------	----------	----------	-----------	-----------	-----------	-----------	----	-----	-----	-----	-----	-----	-----	-----	-----	-----	------	------	------	------	------	------	------	------	------	------	------	------	------	------	------	------	------	------	------	------	------	------	------	------	------	------	------	------	------	------	------	------	------	------	------	------	------	------	------	------	------	------	------	------	------	------	------	------	------	------	------	------	------	------	------	------	------	------	------	------	------	------	------	------	------	------	------	------	------	------	------	------	------	------	------	------	------	------	------	------	------	------	------	------	------	------	------	------	------	------	-------	-------	-------	-------	-------	-------	-------	-------	-------	-------	-------	-------	-------	-------	-------	-------	-------	-------	-------	-------	-------	-------	-------	-------	-------	-------	-------	-------	-------	-------	-------	-------	-------	-------	-------	-------	-------	-------	-------	-------	-------	-------	-------	-------	-------	-------	-------	-------	-------	-------	-------	-------	-------	-------	-------	-------	-------	-------	-------	-------	-------	-------	-------	-------	-------	-------	-------	-------	-------	-------	-------	-------	-------	-------	-------	-------	-------	-------	-------	-------	-------	-------	-------	-------	-------	-------	-------	-------	-------	-------	-------	-------	-------	-------	-------	-------	-------	-------	-------	-------	-------	-------	-------	-------	-------	-------	-------	-------	-------	-------	-------	-------	-------	-------	-------	-------	-------	-------	-------	-------	-------	-------	-------	-------	-------	-------	-------	-------	-------	-------	-------	-------	-------	-------	-------	-------	-------	-------	-------	-------	-------	-------	-------	-------	-------	-------	-------	-------	-------	-------	-------	-------	-------	-------	-------	-------	-------	-------	-------	-------	-------	-------	-------	-------	-------	-------	-------	-------	-------	-------	-------	-------	-------	-------	-------	-------	-------	-------	-------	-------	-------	-------	-------	-------	-------	-------	-------	-------	-------	-------	-------	-------	-------	-------	-------	-------	-------	-------	-------	-------	-------	-------	-------	-------	-------	-------	-------	-------	-------	-------	-------	-------	-------	-------	-------	-------	-------	-------	-------	-------	-------	-------	-------	-------	-------	-------	-------	-------	-------	-------	-------	-------	-------	-------	-------	-------	-------	-------	-------	-------	-------	-------	-------	-------	-------	-------	-------	-------	-------	-------	-------	-------	-------	-------	-------	-------	-------	-------	-------	-------	-------	-------	-------	-------	-------	-------	-------	-------	-------	-------	-------	-------	-------	-------	-------	-------	-------	-------	-------	-------	-------	-------	-------	-------	-------	-------	-------	-------	-------	-------	-------	-------	-------	-------	-------	-------	-------	-------	-------	-------	-------	-------	-------	-------	-------	-------	-------	-------	-------	-------	-------	-------	-------	-------	-------	-------	-------	-------	-------	-------	-------	-------	-------	-------	-------	-------	-------	-------	-------	-------	-------	-------	-------	-------	-------	-------	-------	-------	-------	-------	-------	-------	-------	-------	-------	-------	-------	-------	-------	-------	-------	-------	-------	-------	-------	-------	-------	-------	-------	-------	-------	-------	-------	-------	-------	-------	-------	-------	-------	-------	-------	-------	-------	-------	-------	-------	-------	-------	-------	-------	-------	-------	-------	-------	-------	-------	-------	-------	-------	-------	-------	-------	-------	-------	-------	-------	-------	-------	-------	-------	-------	-------	-------	-------	-------	-------	-------	-------	-------	-------	-------	-------	-------	-------	-------	-------	-------	-------	-------	-------	-------	-------	-------	-------	-------	-------	-------	-------	-------	-------	-------	-------	-------	-------	-------	-------	-------	-------	-------	-------	-------	-------	-------	-------	-------	-------	-------	-------	-------	-------	-------	-------	-------	-------	-------	-------	-------	-------	-------	-------	-------	-------	-------	-------	-------	-------	-------	-------	-------	-------	-------	-------	-------	-------	-------	-------	-------	-------	-------	-------	-------	-------	-------	-------	-------	-------	-------	-------	-------	-------	-------	-------	-------	-------	-------	-------	-------	-------	-------	-------	-------	-------	-------	-------	-------	-------	-------	-------	-------	-------	-------	-------	-------	-------	-------	-------	-------	-------	-------	-------	-------	-------	-------	-------	-------	-------	-------	-------	-------	-------	-------	-------	-------	-------	-------	-------	-------	-------	-------	-------	-------	-------	-------	-------	-------	-------	-------	-------	-------	-------	-------	-------	-------	-------	-------	-------	-------	-------	-------	-------	-------	-------	-------	-------	-------	-------	-------	-------	-------	-------	-------	-------	-------	-------	-------	-------	-------	-------	-------	-------	-------	-------	-------	-------	-------	-------	-------	-------	-------	-------	-------	-------	-------	-------	-------	-------	-------	-------	-------	-------	-------	-------	-------	-------	-------	-------	-------	-------	-------	-------	-------	-------	-------	-------	-------	-------	-------	-------	-------	-------	-------	-------	-------	-------	-------	-------	-------	-------	-------	-------	-------	-------	-------	-------	-------	-------	-------	-------	-------	-------	-------	-------	-------	-------	-------	-------	-------	-------	-------	-------	-------	-------	-------	-------	-------	-------	-------	-------	-------	-------	-------	-------	-------	-------	-------	-------	-------	-------	-------	-------	-------	-------	-------	-------	-------	-------	-------	-------	-------	-------	-------	-------	-------	-------	-------	-------	-------	-------	-------	-------	-------	-------	-------	-------	-------	-------	-------	-------	-------	-------	-------	-------	-------	-------	-------	-------	-------	-------	-------	-------	-------	-------	-------	-------	-------	-------	-------	-------	-------	-------	-------	-------	-------	-------	-------	-------	-------	-------	-------	-------	-------	-------	-------	-------	-------	-------	-------	-------	-------	-------	-------	-------	-------	-------	-------	-------	-------	-------	-------	-------	-------	-------	-------	-------	-------	-------	-------	-------	-------	-------	-------	-------	-------	-------	-------	-------	-------	-------	-------	-------	-------	-------	-------	-------	-------	-------	-------	-------	-------	-------	-------	-------	-------	-------	-------	-------	-------	-------	-------	-------	-------	-------	-------	-------	-------	-------	-------	-------	-------	-------	-------	-------	-------	-------	-------	-------	-------	-------	-------	-------	-------	-------	-------	-------	-------	-------	-------	-------	-------	-------	-------	-------	-------	-------	-------	-------	-------	-------	-------	-------	-------	-------	-------	-------	-------	-------	-------	-------	-------	-------	-------	-------	-------	-------	-------	-------	-------	-------	-------	-------	-------	-------	-------	-------	-------	-------	-------	-------	-------	-------	-------	-------	-------	-------	-------	-------	-------	-------	-------	-------	-------	-------	-------	-------	-------	-------	-------	-------	-------	-------	-------	-------	-------	-------	-------	-------	-------	-------	-------	-------	-------	-------	-------	-------	-------	-------	-------	-------	-------	-------	--------

Printing contents

Header

Site	Displays the site name.
Adaptor	Displays the transmission adaptor name, refrigerant circuit address, and indoor unit No.
Type	Displays the unit type.
Date	Displays the date and time of the display list.
Max EEV	Displays the maximum of the electrical expansion valve of the relevant unit. (*1)
Current Date	Displays the current date.
Ref. No	Displays the refrigerant circuit address.
Unit No	Displays the unit No.
Capacity	Displays the capacity. (Only for outdoor unit)

List

List	Displays the operation history currently being displayed.
------	---

Note



*1 Only indoor unit of S series is displayed.

5-10 Error history screen

Displays the error information for each unit. The error information can sequentially display up to 50 items beginning from the newest error for each unit. This screen can also be printed and the error information can be saved in CSV format.

5-10-1 Name and function of each area

The screenshot shows the VRF System error history screen. The control area at the top includes a dropdown for 'In/Out door Unit', 'Ref. No.' (00), and 'Date' (18/02/2009). Below the control area is a table with the following data:

Model	Address Ref. Unit	Name	Error1	Error2	Error3	Error4
Indoor Unit	00 00		18/02/2009 13:16 42.2 Indoor unit Heat Ex. Middle temp. sensor error	18/02/2009 13:16 42.1 Indoor unit Heat Ex. inlet temp. sensor error		
Indoor Unit	00 63		18/02/2009 13:16 32.3 Indoor unit EEPROM access error	18/02/2009 13:16 32.1 Indoor unit PCB Model information error		
Indoor Unit	01 00		18/02/2009 13:16 12.2 Wired remote controller signal error			
Indoor Unit	01 63		18/02/2009 13:16 12.1 Wired remote controller communication error			
Outdoor Unit	00 00.M		18/02/2009 13:36 71.1 Compressor Temp Sensor 1 Error	18/02/2009 13:34 71.2 Outdoor Temp Sensor 2 Error	18/02/2009 13:16 72.1 Compressor Temp Sensor 1 Error	18/02/2009 13:16 72.2 Compressor Temp Sensor 2 Error

Control area

Device Section	Specifies the unit model. Select from "In/Outdoor Unit", "Peripheral Device".
Ref.No.	Specifies the refrigerant circuit address. (narrow down display)
Date	Specifies the date range to be displayed.
OK	Refreshes the display screen according to the specified conditions.
Request	Request for the latest error information of the specified unit. (VII/JII series)
Clear	Clears all the error history data of the selected refrigerant circuit except for the existing errors.
Print	Prints the list currently displayed.
CSV	Saves the currently specified data to a CSV file.
PREV	Displays errors generated before the time displayed on the screen.
NEXT	Displays errors generated after the time displayed on the screen.
Unit Memory	Displays error names recorded in the indoor / outdoor units.

Display item

Model	Displays the unit model.
Address	Displays the address information (refrigerant circuit address/unit No.) of each unit.
Name	Displays the unit name. (*1)
Error1 ~ 50	Displays the error acquisition time and error contents. Displays currently generated errors in red.

Note *1 Only when preset
(Refer to 3-2-4 Name master database file selection screen.)

5-10-2 Error history display method

The screenshot shows a web-based interface for displaying error history. It features several input fields and buttons. Callout 1 points to the 'Adaptor1' field. Callout 2 points to the 'In/Out door Unit' dropdown menu. Callout 3 points to the 'Ref. No.' fields, which are set to '00' and '01'. Callout 4 points to the 'Date' fields, which are set to '19/12/2008'. Callout 5 points to the 'OK' button. Callout 6 points to the '< Prev' and 'Next >' buttons. Callout 7 points to the 'Clear' button. Callout 8 points to the 'Request' button. Callout 9 points to the 'Unit Memory' button.

- 1** Transmission adaptor display field
The selected transmission adaptor is displayed on the par. 5-5 System list screen.
When you want to change the transmission adaptor, do it from the par. 5-5 System list screen.
- 2** Display unit model selection field
Selects the unit model.
For indoor unit/outdoor unit, select “In/Outdoor Unit” and for centralized remote controller/transmission adaptor, select “Peripheral Device”.
- 3** Refrigerant circuit selection field
Specifies the range of the refrigerant circuit address to be displayed. (*1)
- 4** Date selection field
Selects the range of dates to be displayed. (*2)
- 5** OK button
Refreshes the display data according to the selected conditions by clicking the button. (*3)
- 6** Display item change button
The button displays the next error. (Errors are displayed in groups of 5, such as when Error1~Error5 were displayed, Error6~Error10 are displayed.)
The button returns to the previous error.
- 7** Clear button
Clear the error history data of the selected refrigerant circuit by clicking the button. (*4)
- 8** Request button
Request error history by clicking the button.
- 9** Unit Memory button
When the Unit Memory button is clicked, the Unit Memory screen is displayed.

- Note** *1 If the end refrigerant circuit address is smaller than the start refrigerant circuit address, an error message is displayed.
-  *2 If the end date is earlier date than the start date, an error message is displayed.
- *3 Displays only the units with an error history list.
Troubleshooting screen (refer to 5-16) can be displayed by clicking the error contents of the display. However, excluding “Transmission Adaptor” errors.
- *4 The Clear button can be used only by level 1 users (users who can use all the functions).

5-10-3 Error history printing

The currently displayed error history can be printed by clicking the **Print** button on the error history screen.

- 1 Printer setup and printing
Click on the print tool icon on the right upper corner of the screen and select “Page Setup...”.

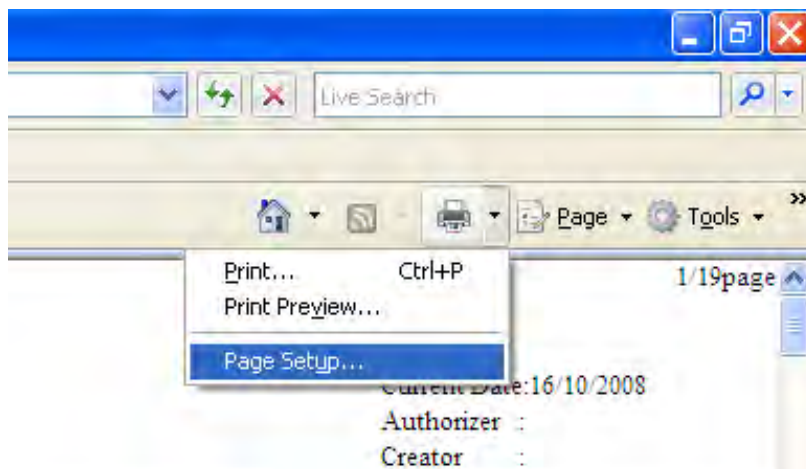

In the Page Setup screen, select the size of the paper as “A3” and the Orientation as “Landscape” and click “OK”. If other option is selected, the print may not come up as good.

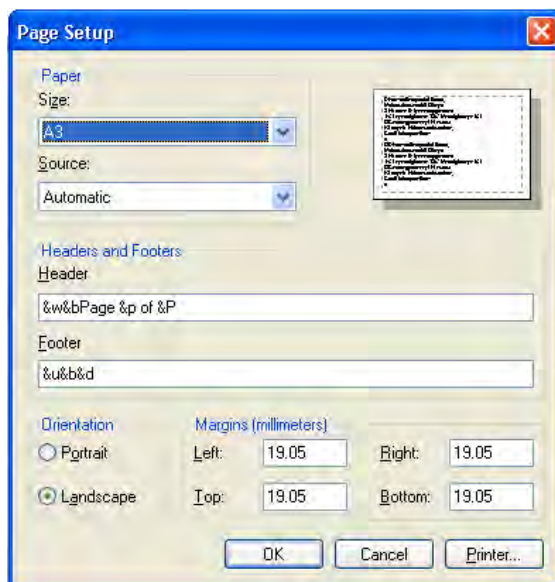

Click on the print tool icon on the right upper corner of the screen again and select “Print...” to start printing.

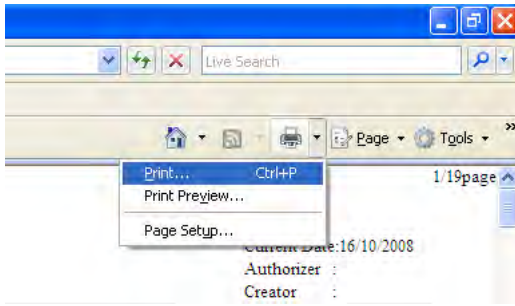

Note For Internet Explorer Ver.6 users, use the sub-menu in “File” menu to bring up the “Page Setup” screen and to perform “Print”.

2 Close button
When the button is clicked, the print window closes.

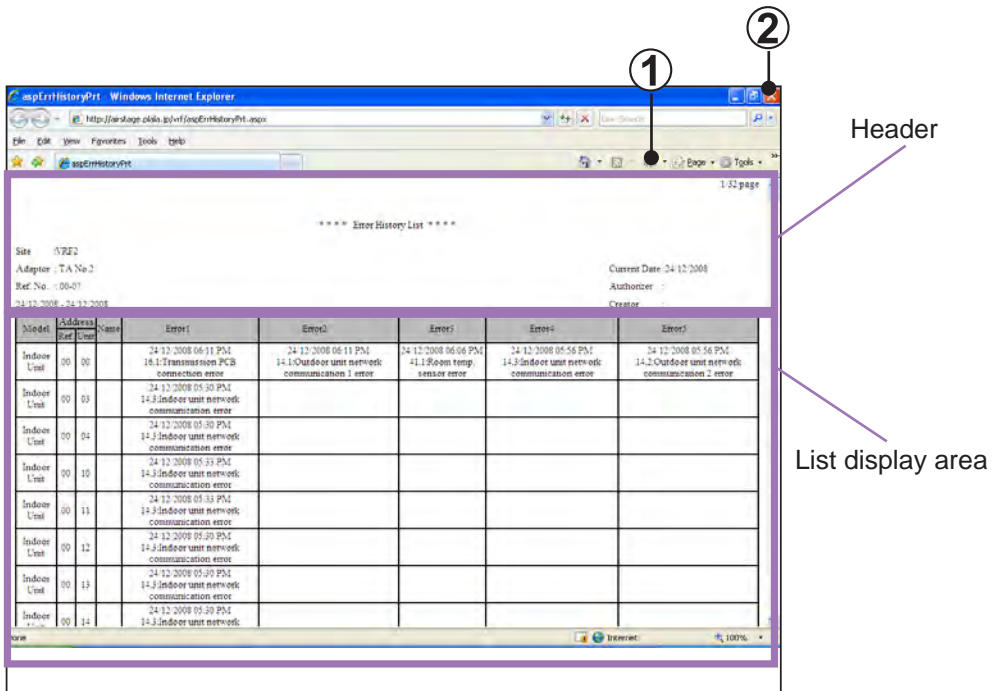

Printing contents
Header

Site	Displays the site name.
Adaptor	Displays the transmission adaptor name.
Ref. No.	Displays the specified refrigerant circuit range.
Date	Displays the date range of the specified data.)
Current Date	Displays the current date.

List display area

List	Displays the error history list displayed on the screen.
------	--

5-10-4 Unit Memory

By clicking the button, the most recent error information recorded in the indoor / outdoor unit will be displayed. Using this screen, you can display the maximum of 20 error information of any specified indoor / outdoor unit.

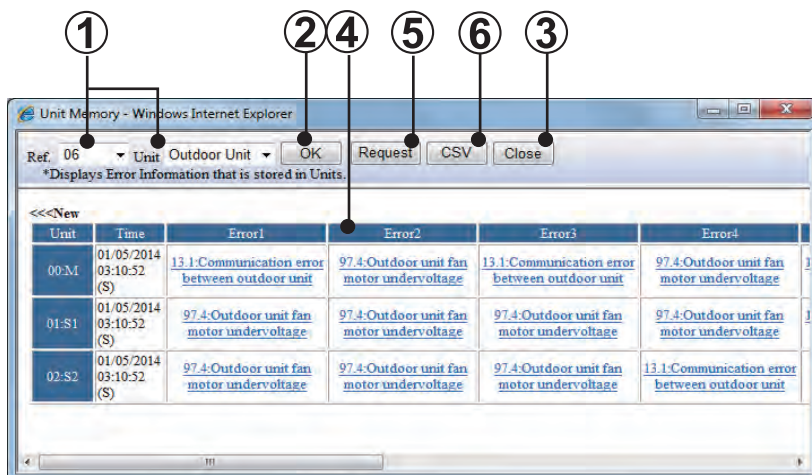

- ① Specify refrigerant circuit address and unit type whose error records are to be displayed. You may only specify unit for the refrigerant circuit of V (Outdoor unit) and VII(Indoor unit) and VII/JII(Outdoor unit) series.
- ② Error information for the refrigerant circuit address specified in ① are displayed below.
- ③ Close this screen.
- ④ Display error information as described below.

Unit	Displays unit address.
Time	Displays the date & time when the error information was acquired from the unit.
Error n n=20 for V series n=10 for VII/JII series	Error n displays error names acquired from the unit. When blank, no error exists. Errors will be sorted by time, [Error1] being the most recent error.

- ⑤ Request error history.
Error history may be acquired for any unit.
- ⑥ Saves the currently displayed error history data to a CSV file.

Note

- This is a supplementary screen to the Error History Screen. Use This screen to check errors not confirmed in the Error History Screen.
- There are cases where the information in this screen and that of Error History Screen do not match. This is because of the differences in the information between the 2 screens.
 - a) Error History Screen displays errors real-time and the data may be deleted at will.
 - b) This screen displays errors recorded in the indoor / outdoor unit at one time.
- Errors in this screen do not have information on dates.

5-10-5 Request Error History

By clicking the button, the most recent error information will be acquired for the specified units. The acquired information can be displayed as previously explained in “Error history display method” section. You may only use this function for VII/JII series.

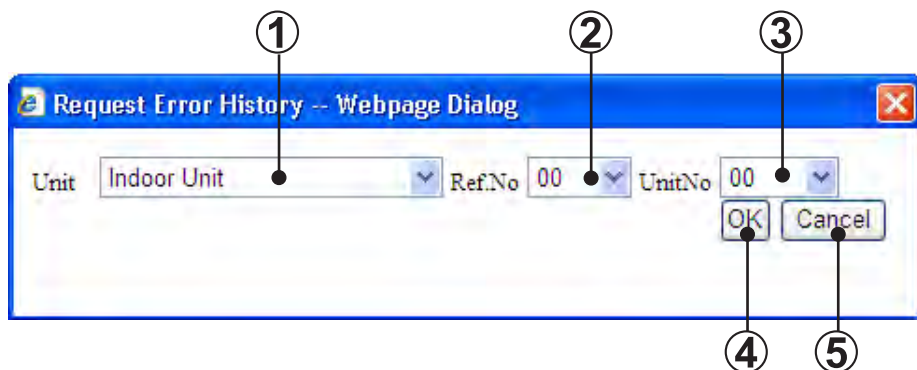

- ① Specify unit type whose error information is to be requested.
- ② Specify refrigerant circuit address whose error information is to be requested.
- ③ Specify unit No. whose error information is to be requested.
- ④ Perform request.
- ⑤ Cancel request



Note Requesting error of particular unit using this screen may become necessary when immediately after connecting Web Monitoring Tool to a system and you need the latest error information.

5-11 Control screen

Operation of each refrigerant circuit address, indoor unit No. or each R.C. Group can be controlled.

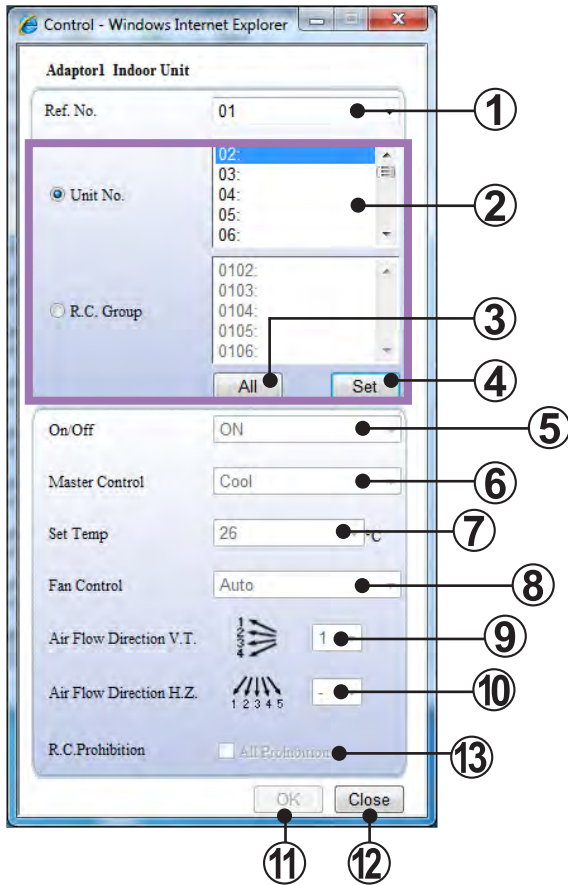

- ①** Ref No. selection field
Selects the refrigerant circuit address (The refrigerant circuit address to be registered can be selected.)
- ②** Control objective selection field
When specifying in unit units, select "Unit" and when specifying in R.C. Group units, select "R.C. Group". (Unit No and R.C. Group cannot be selected simultaneously.)
Multiple units can be selected by pressing "ctrl" key while selecting.
- ③** All
Selects all the displayed units (displayed at ②).
- ④** Set button
Fix the unit selection
- ⑤** On/Off selection field
Selects the operating status. (Select from On/OFF/On (Test).)

- ⑥ Master Control selection field
Selects the operating mode. (Select from Cool/Heat.)
- ⑦ Set Temp selection field
Selects the temperature. (*1)
- ⑧ Fan Control selection field
Selects the air flow. (Select from Auto/S-Low/Med/High.)
- ⑨ V. T. Louver
Select the vertical louver position.
- ⑩ H. Z. Louver
Select the horizontal louver position.
- ⑪ OK button
Controls operation according to the specified contents.
- ⑫ Close button
Closes the screen without taking any action.
- ⑬ R.C. Prohibition
Specify that all operation using remote controller will be prohibited. *2
Checked ... Operation prohibited, Unchecked ... Not prohibited.

Note *1 Displayed in Celsius or Fahrenheit depending on the data acquisition application setting.
The settable range depends on the series.

Mode	Series	Celsius	Fahrenheit
Cool	All	18~30°C	64~88°F
Heat	S	16~30°C	60~88°F
	V / VII	10~30°C	48~88°F

*2 When setting the R.C. Prohibition, be sure to release the prohibition afterward.

5-12 Others screen

Various setting may be performed and any existing data may be downloaded.

When the Others button is clicked from the main menu, the following Others menu is displayed at the bottom of the main menu.

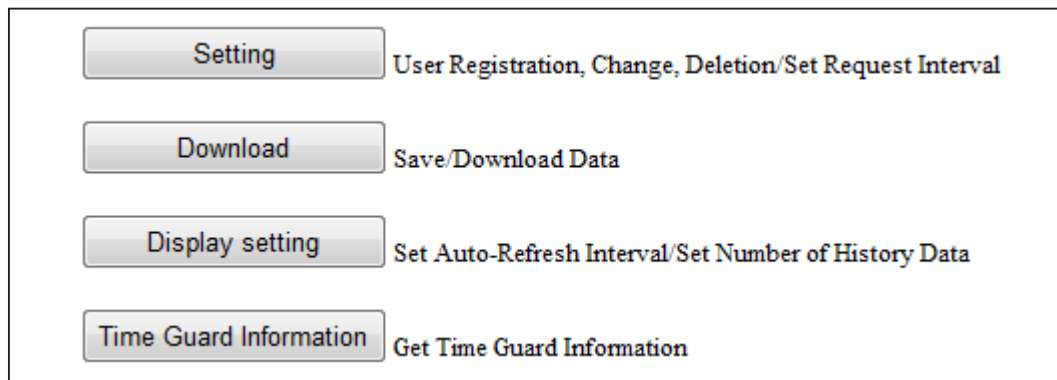

Setting	Performs new user registration, user password change, registered user deletion, and demand interval setup. (Refer to 5-15 Others screen (Setting))
Download	Any unit data currently displayed can be saved. (Refer to 5-16 Others screen (Download))
Display setting	Setting Auto-refresh interval and maximum No. of lines per page. (Refer to 5-14 Others screen (Display setting))
Time guard information	Time guard information is acquired from a unit and the CSV file output. (Refer to 5-15 Others screen (Time guard information))

5-13 Others screen (Setting)

Performs user registration, user password change, registered user deletion, and demand interval setup. When the Setting button is clicked from the Others screen, the following setting menu is displayed at the bottom of the main menu. Each setting processing can be performed only when a Level 1 user was logged in by Server. In other cases, buttons are not displayed at the main menu. (Refer to par. 5-4 Main menu.)

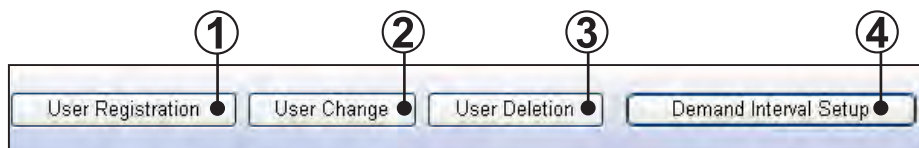

- ①** User registration button
Shifts to the user registration screen.
- ②** User change button
Shifts to the user change screen.
- ③** User deletion button
Shifts to the user deletion screen.
- ④** Demand interval setup button
Shifts to the demand interval setup screen.

5-13-1 User registration

Registers new user ID and password. A data acquisition application start user can be added.

The screenshot shows a web browser window titled "VRF System - Microsoft Internet Explorer". The address bar shows "VRF". There are navigation buttons for "System List", "Detail", "History", and "Error". Below the browser window, there are four buttons: "User Registration", "User Change", "User Deletion", and "Demand Interval Setup". The "User Registration" button is selected. The form contains the following fields:

- New UserID:
- New Password:
- Confirm New Password:
- Level:
- OK:

Numbered callouts 1 through 5 point to the New UserID field, New Password field, Confirm New Password field, Level dropdown, and OK button respectively.

- ① User ID input field
Input the user ID. (Up to 20 alphanumeric characters) (*1)
- ② Password input field
Input the password. (Up to 20 alphanumeric characters) (*1)
- ③ Password confirmation input field
For confirmation, input the password again. (Up to 20 alphanumeric characters) (*2)
- ④ User level selection field
Select the user level. Level 1 or level 2 can be selected.
Level1 : All functions can be used.
Level2 : All functions except control, commissioning tool, and setting can be used.
- ⑤ OK button
Registers the inputted contents. (*3)

- Note**
- *1 If the user ID and password input fields are not inputted, an error message is displayed.
 - *2 If there is a difference in the password and password confirmation input contents, an error message is displayed.
 - *3 If the same user ID is already registered, an error message is displayed.

5-13-2 User change

The password of a registered user can be changed.

The screenshot shows a web browser window titled 'VRF System - Microsoft Internet Explorer'. The page has a navigation bar with buttons for 'User Registration', 'User Change', 'User Deletion', and 'Demand Interval Setup'. The 'User Change' section contains the following form elements:

- UserID:** A text input field containing 'vrf'.
- Password:** A text input field.
- New Password:** A text input field.
- Confirm New Password:** A text input field.
- Level:** A dropdown menu currently showing '1'.
- OK:** A button to submit the form.

Numbered callouts (1-6) are placed to the right of the form, with lines pointing to each of these elements.

- ①** User ID selection field
Select the user to be changed.
The currently registered users can be displayed and selected with
- ②** Password input field
Input the password of the user to be changed. (Up to 20 alphanumeric characters) (*1)
- ③** New password input field
Input the password to be newly registered. (Up to 20 alphanumeric characters) (*1)
- ④** New password confirmation input field
For confirmation, input the password again. Input the same password as the new password. (*2)
- ⑤** User level selection field
Select the user level. Level 1 or level 2 can be selected.
Level1 : All functions can be used.
Level2 : All functions except control, commissioning tool, and setting can be used.
- ⑥** OK button
Performs change processing according to the inputted contents. (*3)

- Note**
- *1 When the password and new password input fields are not inputted, an error message is displayed.
 - *2 When the contents input at the new password and new password confirmation input fields do not match, an error message is displayed.
 - *3 When the password of the selected user ID is incorrect, an error message is displayed.

5-13-3 User deletion

Deletes registered users.

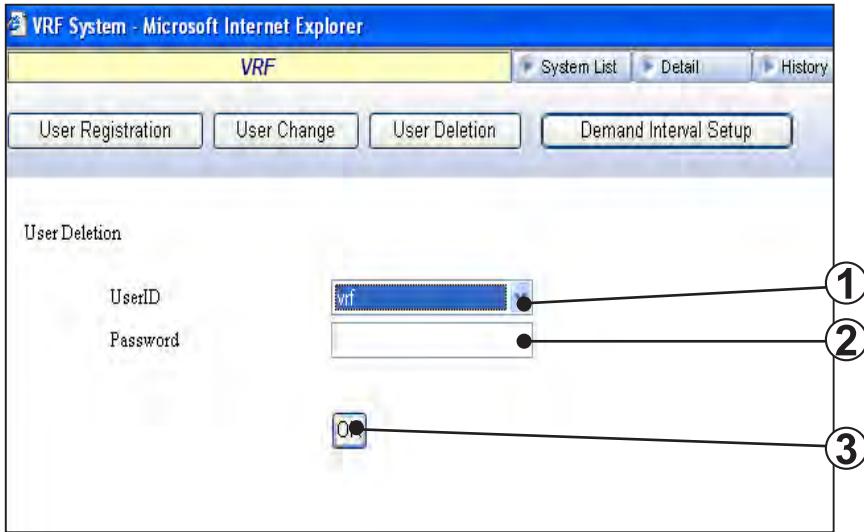

- 1** User ID selection field
Select the user to be deleted.
The currently registered users can be displayed and selected with .
- 2** Password input field
Input the password of the user to be deleted. (Up to 20 alphanumeric characters) (*1)
- 3** OK button
Deletes the selected user. (*2)

Note *1 When the password input field is not inputted, an error message is displayed.
i *2 When the selected user ID and password do not match, an error message is displayed.

5-13-4 Demand interval setup

Specifies the interval at which the temperature, pressure information, and electrical components operating status is specified for each unit in the VRF System. The refresh interval of the data displayed at the system list, operation history, and unit detail screens is changed by changing this setting. When the demand interval is set to a small value, the data refresh interval becomes shorter, but the data may be received correctly by an error. At this time, set this interval to a large value.

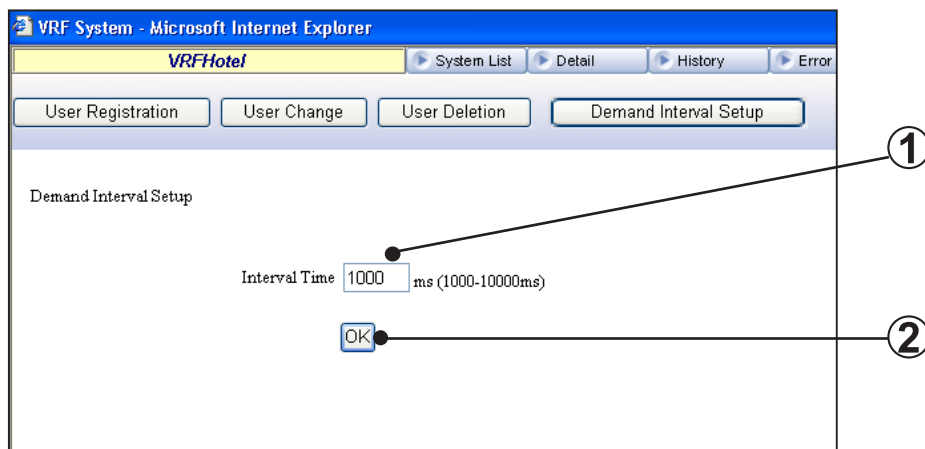

- ① Interval time input field
Set the demand interval time. (*1)
- ② OK button
Refreshes the demand interval time according to the inputted time.

Note *1 The currently set time is displayed by default. Only the numerics 1000 to 10000 (ms) can be inputted. When input is incorrect or there is no inputted, an error message is displayed.

5-14 Others screen (Download)

Any unit data currently displayed can be saved. The saved data may be displayed as offline data for Service Tool Ver. 1.2.

When the Download button is clicked from the Others screen, the following setting menu is displayed at the bottom of the main menu.

The screenshot shows a web browser window titled "VRF System - Windows Internet Explorer". The page displays the "Others" screen for a system named "J2". The control area includes a dropdown menu for "All Data" (with sub-options: All Data, Manual Data, Auto Data), a "System List" tab, and a "Detail" tab. Below these are filters for "Adaptor Adaptor1" and "Period 02/06/2011 00:00:00 -> 03/06/2011 00:00:00". There are also buttons for "All", "Ref. No.", "List", "Refresh", and "Create Download File".

The list display area contains a table with the following data:

FileName	Date	Size(KB)	
Adaptor2-All-20110511-20110511-113805.gz	11/05/2011 23:28:29	717	Delete
Adaptor1-Ref.all-201105110000-201105120000-113331.gz	11/05/2011 23:33:20	691	Delete
Adaptor1-Ref.all-201106020000-201106030000-114948.gz	12/05/2011 23:50:03	588	Delete
Adaptor1-Ref.muti-201106020000-201106030000-115202.gz	12/05/2011 23:52:17	582	Delete
Adaptor2-All-20110511-20110518-114210.gz	18/05/2011 23:43:32	639	Delete
Adaptor2-All-20110518-20110525-114854.gz	25/05/2011 23:50:09	693	Delete
Adaptor2-All-20110518-20110526-111142.gz	01/06/2011 23:12:37	629	Delete

5-14-1 Name and function of each area

■ Control area

Specify the conditions and creation of data file to be downloaded.

Download file display switching	Switches and displays the files displayed at the list display area for each of the following types. All files/files created arbitrarily/automatic backup files
Adaptor	Displays the transmission adaptor name.
All & Ref.No. List	Specify the refrigerant circuit address of the data file.
Period	Specify the period of the data file.
Refresh	Update the contents of "List display area".
Create Download File	Create data files.

■ List display area

Display the list of created data files. Also, any data files may be specified for download and/or deletion.

FileName	Display the file names created in the Control area. Also any data file may be downloaded.
Date	Display date of creation of the data files.
Size	Display the size (in KB) of the data files created. When creation is in progress, display the status of progress.
Delete	Delete any data file.

5-14-2 Procedures for Creating Download Files

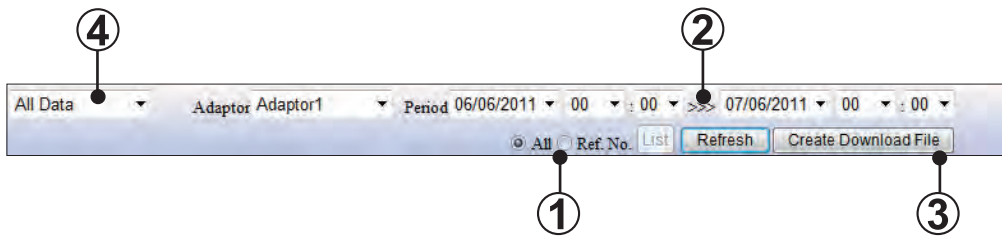

- 1** All & Ref. No.
Specify the range of refrigerant circuit of the data files to be created by one of the following methods. If Ref. No. is specified, refrigerant circuit address selection screen will be show up by clicking the List button. Specify the desired refrigerant circuit address here.
- All All refrigerant circuit address are specified.
 - Ref. No Refrigerant circuit address selected in the refrigerant circuit address selection screen will be specified.

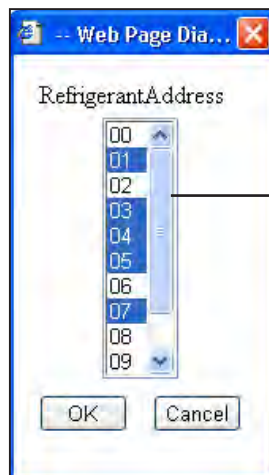

Refrigerant Address selection screen

- 2** Period.
Specify the period (Start >>> End) of the data file to be created by date and time.
- 3** Create Download File
Start creating data files using the condition specified by **1**, **2**. Creation progress may be checked with the FileName in the "List display area".
- FileName format is as follows;
[Transmission adaptor name - Ref all or Ref multi *- Period - time]
→The operation data files created by specifying arbitrary conditions.
[--Error- - Transmission adaptor name - Ref all or Ref multi *- creating time - index]
→Operation data file created automatically for the refrigerant circuit address where any of the unit belonging to that refrigerant circuit has caused error. This file is created at 2 AM every night for errors that occurred the previous day.
* Ref all ... All / Ref multi ... Ref.No.

- There 3 progress status.
 - Completed ... Only File name (File name will be underlined)
 - Creating ... Now creating file ... File name
 - Waiting ... Requesting ... File name

④

Download file display switching

Switches and displays the download files for each of the following types.

- All Data ... Displays all the Download files.
- Manual Data ... Displays only the Download files created at ③
- Auto Data ... Displays only the backup use Download files (Data for 1 week) that are created automatically every Sunday (3 o'clock). This file holds the backup files for up to 1 month before. Backup files before this are automatically deleted.

5-14-3 Data file download/deletion

FileName	Date	Size [KB]	
<u>06F-11F-Ref.all-200508250000-200508260000-040221.gz</u>	25/08/2005 04:03:46	640	Delete
<u>06F-11F-Ref.multi-200508250000-200508260000-040625.gz</u>	25/08/2005 04:06:43	520	Delete
<u>06F-11F-Ref.multi-200508240100-200508240400-040728.gz</u>	25/08/2005 04:07:48	524	Delete
Now creating file., '06F-11F-Ref.multi-200508210300-200508220000-040753.gz'	25/08/2005 04:07:52		
Requesting ., '06F-11F-Ref.multi-200508250300-200508260000-040812.gz'	25/08/2005 04:08:11		Delete

① points to the underlined file name in the first row. ② points to the Delete button in the last row.

①

Download

Click on the (underlined) file name that you want to download.

②

Delete button

Click on the "Delete" button on the same line as the file name that you want to delete.

5-15 Others screen (Display setting)

Make display setting for the “Detail” screen and “Operation history” screen.

When the Display setting button is clicked from the Others screen, the following setting menu is displayed at the bottom of the main menu.

Detail

Auto-Refresh Interval sec (1-60sec) ● ①

History

Maximum Number of Lines per Page lines (25-500lines) ● ②

OK ● ③

- ① Auto-Refresh Interval (*1)
Set “Detail” screen update interval. This defines not the screen update interval but interval for checking the existence of updated data. The check will be performed in this interval and if the data is updated, the screen display will be updated.
- ② Maximum number of Lines per Page (*1)
Defines the maximum number of data that can be displayed in a page of Operation history screen.
- ③ OK button
Register the data set in ①, ②.

Note *1 Depending on the performance spec. of personal computer used, operation of this software may become slow. In such case, re-adjust the value set and check the operation.

5-16 Others screen (Time Guard Information)

5-16-1 Time Guard Information

Reference data for judging the maintenance period of indoor and outdoor units (compressor, FAN, etc. integrated time) is output to a CSV file. (VII/JII series)

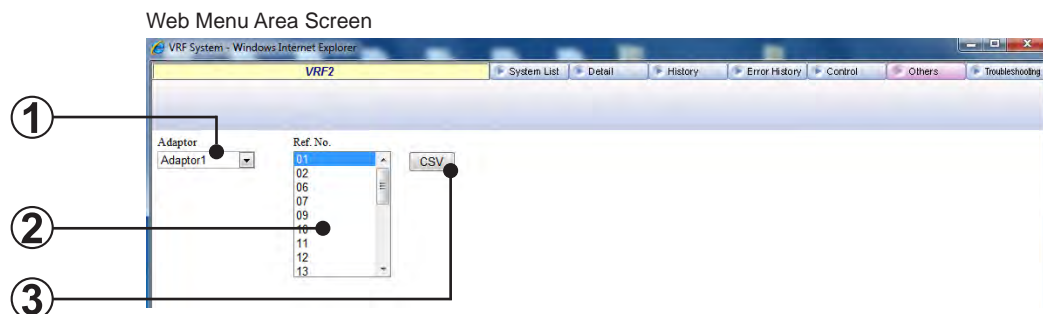

- ① Adaptor selection
Selects the transmission adaptor which connects the target unit.
- ② Refrigerant circuit address selection
Specified the units which acquires this data in refrigerant system units.
- ③ CSV button
Outputs the Time Guard data of the indoor units and outdoor units belonging to the refrigerant circuit address selected at ②.

5-17 Troubleshooting screen

Displays the error contents and corrective action. Display is performed from the main menu and error history screen.

5-17-1 Name and functions of each area

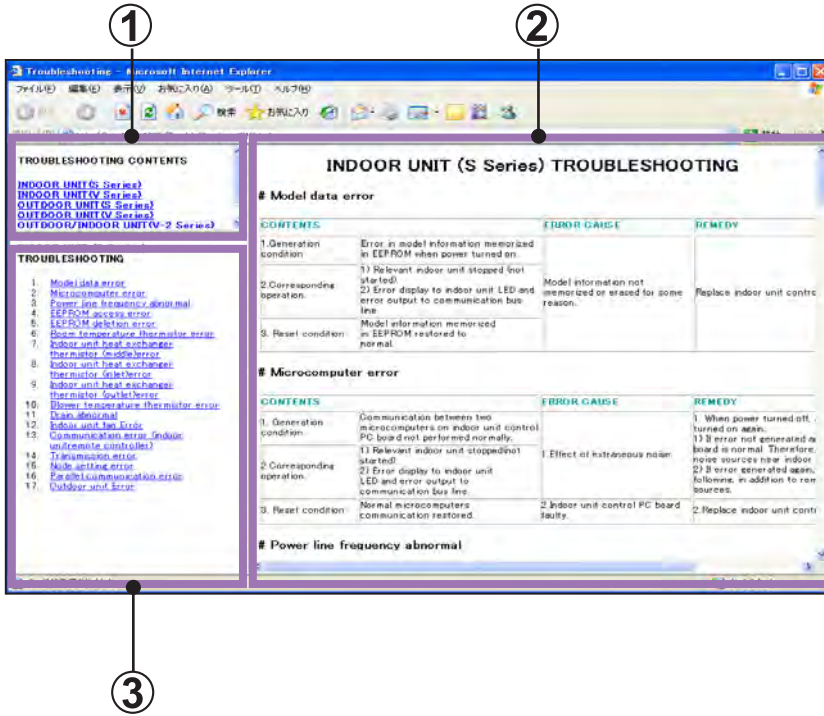

- 1** Contents area by type
When contents are clicked, the contents of the error contents are displayed.
- 2** Troubleshooting contents display area
Displays the error details.
For VII/JII series, this area will be displayed full screen.
- 3** Contents area for each error contents
When contents are clicked, those contents are displayed.
This area will not be displayed for VII/JII series.

Note When VII/JII series is selected, trouble shooting section from service manual will be displayed. This will give you a precise and detailed instruction on trouble shooting.

5-18 Log out

Logs out. When par. 5-4 Main menu is clicked, a confirmation message is displayed.



- 1** OK button
Logs out. Closes the main screen and shifts to the login screen.
- 2** Cancel button
Returns to the original screen without logging out.

5-19 When error generated

When the Web Monitoring Tool (WEB application) cannot be used, the following screen is displayed.

5-19-1 Scanning other units

Displays when bus priority processing was generated at another unit (Touch Panel Controller, other System Controller). In this case, all operations which perform communication become impossible. When scanning ends, the display automatically returns to the processing screen and operation becomes possible.

- 1 Message
The unit name being scanned is displayed.

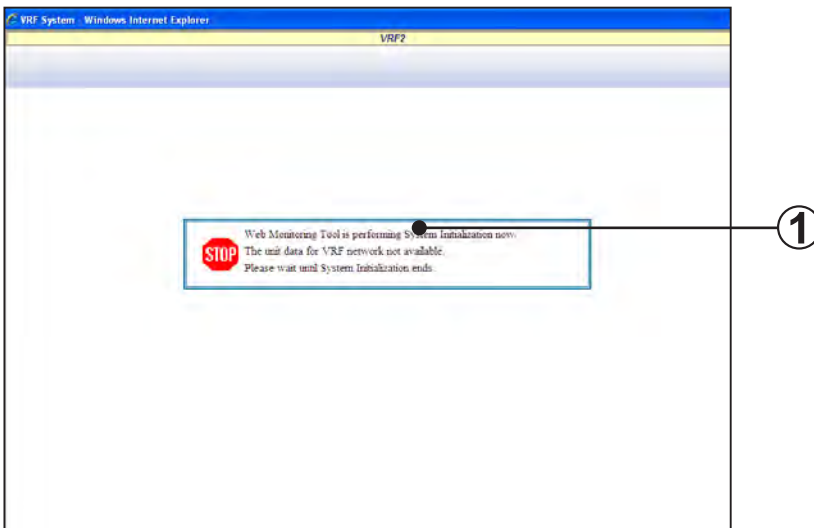

5-19-2 Data acquisition application shutdown

Displays when the data acquisition application is shut down. All operations are impossible. Start the data acquisition application.



6. Troubleshooting

When a problem occurred during operation, refer to this section. This section describes assumed problems and how to solve them.

T-1 A transmission adaptor connection error was generated.

Cause

- ① Driver is not installed.
- ② Power is not supplied to the transmission adaptor.

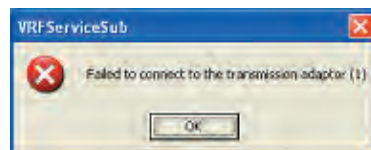

Countermeasure

- ① To use this product, install necessary drivers/software for this product following the ***QUICK START*** enclosed with this product.
- ② Make sure that USB equipment (USB hub, etc.) that this product is connected to, is not overloaded (power supplied thru the interface does not exceeds the maximum limit).

T-2 Forms cannot be printed.

Cause

- ① Printer power is not ON.
- ② Printer cable between PC and printer is not properly connected.
- ③ Printer driver is not correctly installed.

Countermeasure

- ① Check if the printer power is ON.
- ② Check if the printer cable is connected.
- ③ Print forms by performing printing processing by Windows® setting. Refer to Windows® printing troubleshooting, and check whether or not the Windows® printer setting is correct.

T-3 “Master Abnormality.” message was displayed by the browser.

Cause

There is an abnormality in the master data.

Countermeasure

The database backed up last time is automatically restored. This software cannot be used until completion of restore processing. Since restore processing takes several minutes, wait a while before performing operation. The data backed up the previous time and subsequently is lost. After recovery, check the data.

T-4 “Can not control this transmission adaptor.” message was displayed by the browser.

Cause

The system entered a state in which it cannot control operation because the name master data was not received.

Countermeasure

Wait until the Web Monitoring Tool automatically acquires each name master data, and then scan by detailed information scanning setting. For details, refer to par. 3-2-5 Scanning.

T-5 “No data existing.” message was displayed by the browser.

Cause

Data cannot be displayed because the unit data which is the display objective was not received.

Countermeasure

Wait until the Web Monitoring Tool automatically acquires each unit data, and then set Intensive Data Acquisition (IDA) Mode at the system detail screen. For details, refer to par. 5-6-1 Name and function of each area.

T-6 “Server access error occurred.” message was displayed by the browser.

Cause

- ① Error was generated when accessing the database.
- ② The database may have been stopped by some cause.
- ③ The database may have been destroyed.
- ④ PC memory is used up.

Countermeasure

- ① Close the browser and redo from login.
- ② Restart the PC and then restart the Web Monitoring Tool.
- ③ The database backed up last time is automatically restored. This software cannot be used until completion of restore processing. Since restore processing takes several minutes, wait a while before performing operation. The data backed up the previous time and subsequently is lost. After recovery, check the data.
- ④ Close all applications and stop unnecessary services of the PC in order to free memory. Add extra memory if possible (refer “3-2 Recommended specs” of Setting Manual).

T-7 During scanning, PC power was dropped by a power failure or erroneous operation and operation became unstable.

Countermeasure

At a power failure, incomplete data remains and operation may be performed with this incomplete data at the next starting. Repeat scanning. When the power was interrupted during another operation, the operation may return to normal by the same operation after resetting.

To permanently prevent these, installation of a UPS is recommended.

T-8 E-mail was not received at the set address.

Cause

- ① E-mail address setting is incorrect.
- ② Transmission mode setting at environment was not set to match the usage environment.
- ③ Dial-up connection setting is incorrect.
- ④ Service was temporarily stopped due to line congestion or provider maintenance.

Countermeasures

- ① Check the e-mail address setting.
⇒ Check par. 4-3-3 Error notification e-mail setting.

- ② Check the transmission mode setting.
⇒ Check par. 4-3-2 Transmission mode setting.
- ③ Check the dial-up connection setting.
Refer to the documentation of the contracted provider and check the setting.
- ④ The provider used may not be in an unusable state. Since the system tries to send every 5 minutes, wait until the provider recovers.

T-9 Air conditioner is not controlled in R.C. group units.

Cause

R.C group data cannot be acquired.

Countermeasure

Repeat scanning by detailed information scanning setting.

T-10 Displayed text is garbled.

Cause

PC regional setting is incorrect.

Countermeasure

Set ** Setting Manual ** par. 6-1-1 Regional option to “English (United Kingdom)”.

T-11 Cannot connect from client to server.

Cause

- ① Connection environment between server and client is not created.
- ② Network setting is incorrect.
- ③ Specification at connection is incorrect.

Countermeasures

- ① Inspect and check the following contents regarding the connection environment.
 - Check the physical connection. (Cable not connected? Connection point correct?)
 - Check the operation status by network device error lamps, etc.
 - Contact the telephone company and check the state of the line.
 - Ask the provider about the trouble status.
- ② Check the network settings.
 - Check the IP address/subnet mask settings.
⇒ Check the contents specified at item ⑤ of par. 6-3-2 LAN connection of the Setting Manual.
 - Check the connection destination telephone number.
When connecting to an internet that used dial-up connection

⇒ Check the procedure supplied by the provider.

Incoming connection

⇒ Check the telephone number specified at item ⑨ of par. 6-3-5 Dial-up setting of the Setting Manual.

- Check the firewall setting.

Setting of server itself (Windows® XP SP2 and later)

⇒ Check the par. 6-1-2 Windows® Firewall setting of the Setting Manual.

When Firewall installed

⇒ Check enable port No. 80 connection from the outside setting.

③ Check specification at connection.

- At incoming connection, check the user name/password input by the client.

⇒ Specify the user and password at the screen of step ⑪ of par. 6-3-4 Incoming connection remote connection setting of the Setting Manual.

- Check the connection destination specification (IP address/server name) at input from the browser.

⇒ Check the Web application starting method of par. 5-1-1 Web application starting conditions and functions change of the Operation Manual.

T-12 Suddenly cannot connect to server.

Cause

① Sever power was tripped.

② Web Monitoring Tool application was exited at server.

③ Service temporarily stopped due to line congestion, provider maintenance, etc.

④ Setting of DNS service at provider takes time.

Countermeasures

① Supply power to the server PC and restart.

② Start the Web Monitoring Tool application.

③ After waiting a while, reconnect.

④ Perform internet connection and after waiting a while, login to the server.

T-13 Response was slow when Web Monitoring Tool server was accessed.

Cause

① Transmission line speed may be slow.

② Specifications of installed PC may be slow.

Countermeasures

① Switch transmission line contract to fast line.

- ② Operate with a PC that satisfies the published specifications.

T-14 Template file for the Commissioning Report (CommissioningReport.xls) can't be opened.

Cause

Security level in Excel is set to "High".

Countermeasure

Start Excel, from the "Tool" menu;

Select [Tool], [Macro], [Security] then,

in the "Security Level" tab, set the level to "Medium" or "Low".

T-15 Pop-up window does not show up in the Web Monitoring Tool screens. (Control screen, Commissioning tool, etc.)

Cause

Pop-up Blocker is enabled in the Internet Explorer.

Countermeasure

- ① Open Internet Explorer → [Tools] → [Pop-up Blocker] and check [Turn Off Pop-up Blocker]

- ② If any of the search tool bar from various search engines (Yahoo, Google etc.) is installed, disable the Pop-up Blocker.
(For detail, refer the help of each toolbar.)

T-16 Refrigerant circuit diagram is not displayed for outdoor/indoor unit in the Detail screen (diagram).
(Message "Cannot display refrigerant circuit diagram" is displayed).

Cause

Model name was not acquired from indoor/outdoor unit (VII/JII series).

Countermeasure

- ① Perform scan again (Refer section 3-2-5 Scanning).
After scanning, check that the model name is displayed in the System List screen.

- ② If the name is not displayed in the System List screen, enter the correct model name for the unit in the Name master database file (Refer section 3-2-4) and select "re-scanning" from the right-circle menu in the task tray.
When requested for the Name master database file, specify the file, but the following scan may be cancelled.

- T-17 The following message is displayed during use.
“Internet Explorer has stopped working. A problem caused the program to stop working correctly. Windows will close the program and notify you if a solution is available.”

Cause

Add-on function used by Internet Explorer 8 is enabled.

Countermeasure

When using this tool, disable the Add-on functions used by Internet Explorer 8 by the following procedure:

[Internet Explorer] → [Tools] → [Manage Add-ons] → [Toolbars and Extensions] →
Select the displayed Add-on function → Right click → Select [disable]

- Q-1 Can the Web Monitoring Tool be restarted by installing it on the same PC as the System Controller or other Software tool and using the same transmission adaptor?

Answer

The Web Monitoring Tool can be installed on the same PC, but simultaneous operation is outside the warranty. Also, each application cannot simultaneously share 1 transmission adaptor.

- Q-2 Can a browser other than Internet Explorer be used?

Answer

Other browsers cannot be used because they are incompatible.

- Q-3 Can multiple servers at a large type site be collectively monitored with 1 network line contract?

Answer

An LAN must be built through a router at the server side. For more information, contact the network administrator or dealer.

- Q-4 For internet connection, may not information be read by other users on the network?

Answer

The security level can be increased by any of the following methods

- ① Use VPN connection. For more information, refer to the related documents related to Windows®, or contact the dealer.
- ② Change to a connection method that uses incoming connection. The possibility of the leakage of information is lower than for internet connection. For more information, refer to par. 6-3-4 Incoming connection of the ** Setting Manual **.

Q-5 Air conditioners cannot be controlled from the client.

Cause

Security is emphasized so that the air conditioners cannot be controlled from the client.