

Operating Manual for Daikin Multi-heatpump Air Conditioners

Use it properly for comfortable living

Multi-heatpump type **FTY22JVE1F**

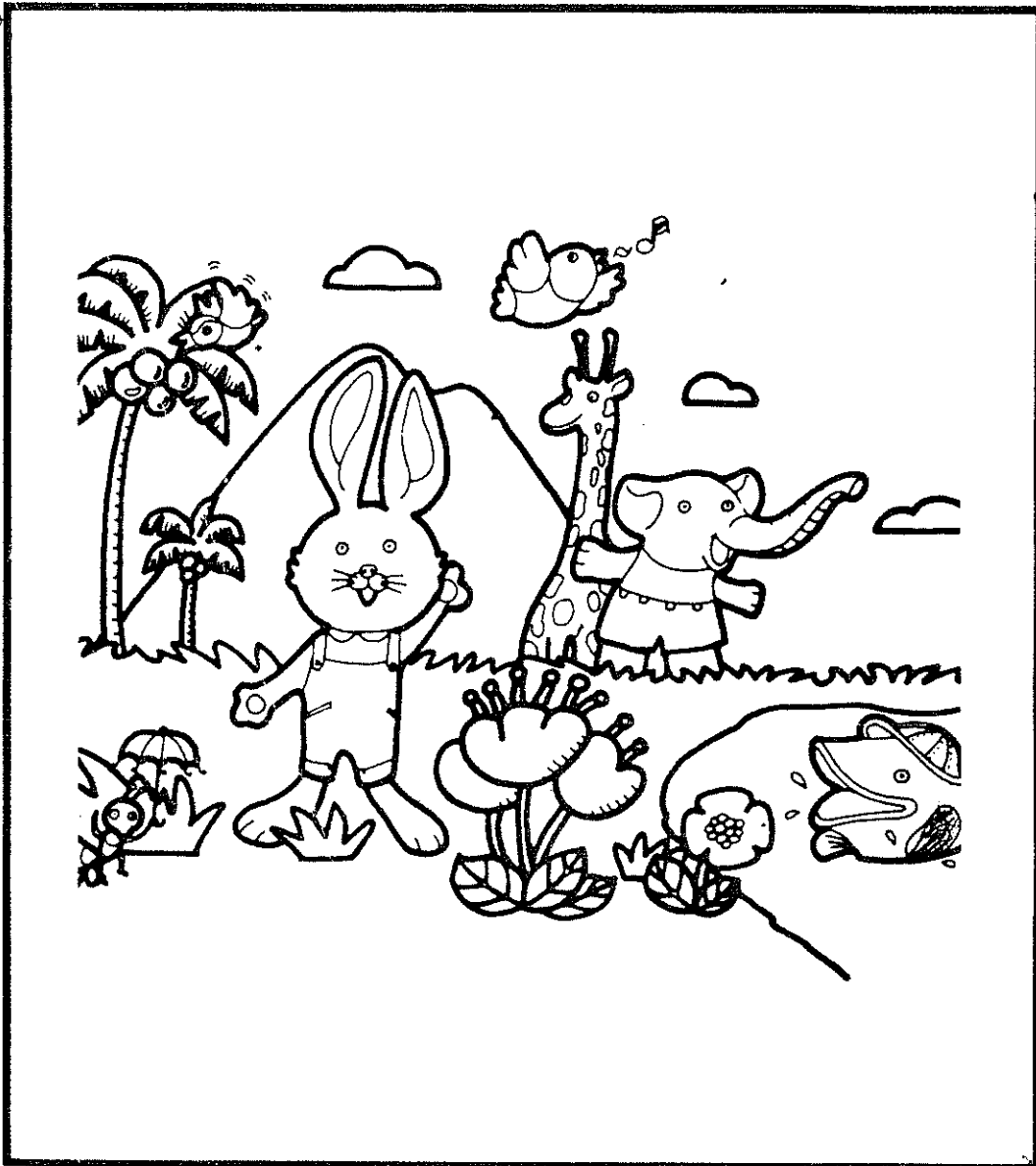

Carefully read this manual before operation and use the air-conditioner for a long time.

- This manual will help you when trouble occurs with it.

***THANK YOU VERY MUCH FOR PURCHASING THE DAIKIN
FAN COIL UNIT AND AIR COOLED CONDENSING UNIT***

	page
INSTALLATION	1
PROHIBITIVE ITEMS	3
CAUTION FOR OPERATION	4
RECOMMENDATION FOR ECONOMICAL OPERATION IN POWER CONSUMPTION	6
OPERATING CONDITIONS	7
NAME AND FUNCTION OF COMPONENTS	8
FUNCTION OF CONTROL PANEL	9
OPERATION ORDER	10
EFFECTIVE OPERATION FOR MULTI-ROOM AIR CONDITIONERS	14
MAINTENANCE	16
MAINTENANCE BEFORE AND AFTER PROLONGED IDLE PERIOD	17
INSPECTION BEFORE CALLING AFTER SALES SERVICE	18

INSTALLATION

To operate the air conditioner effectively and comfortably without annoying your neighbours, confirm the following points for installation.

If anything wrong is found, rectify it before operation. Do not provide the wiring work by yourself, but ask your Daikin dealer.

■ Installation position

- Avoid such a place where there is fear of inflammable gas leakage, as explosion or fire may occur.

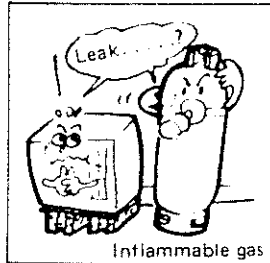

- Install the condensing unit in such a place which is not spoiled by water (drainage) drops from the condensing unit.

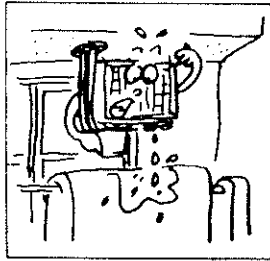

- * Since drainage comes out of the condensing unit, do not place anything which is spoiled by water or install the unit in such a place where water from the unit annoys your neighbour.

- Install the condensing unit where there is easy access for maintenance or after-sales services.

- * If the unit is installed where access is difficult, costs of inspection and repairing work become rather expensive.

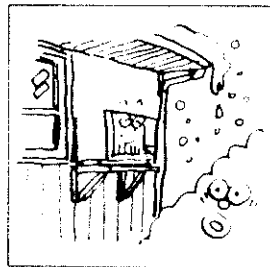

- Confirm that air suction inlet and discharge outlets of the condensing unit are not covered with snow.

- * If the air conditioner is operated with its air suction inlets and discharge outlets covered with snow, heating capacity reduces and eventually it may cause trouble.

- Confirm that cold wind does not pass through the condensing unit continuously.

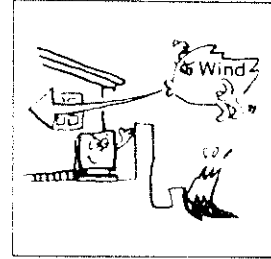

- * If cold wind passes through the condensing unit while defrosting, defrosting period may be prolonged.

- Do not install the air conditioner (both fan coil and condensing units) and the remote control kit near the electric power facilities such as electric drill, pump, etc. and a boiler.

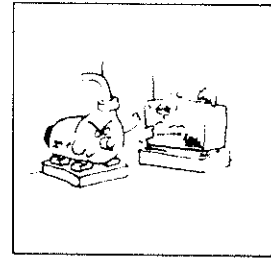

- * The room air conditioner may run erratically due to back electric wave (jamming). Be sure to locate them apart from these materials by at least over 1.5 m.

(The air conditioner should not be installed in special places which are greasy, salty such as near a beach, and are subject to sulfid gas such as near hot springs or to other chemicals, or affected by voltage fluctuation greatly such as in factories.)

- Confirm that the remote control unit is not subject to direct sunlight. In addition, confirm that the remote control unit is installed in such a place that is well ventilated and is most suitable for detecting the whole room temperature fluctuation.

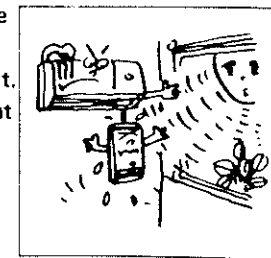

- * Wrong installation of the remote control unit may cause erratic operation of the thermostat.

- Do not lay the remote control unit on a desk or anything like that.
- Confirm that the remote control unit body is fixed to the wall or a pillar.
- Confirm that the remote control unit is fixed where it is difficult to be reached by children.

(Noise precaution)

- Install the air conditioner in such a place which is strong enough to support weight of the air conditioner and does not amplify noise or vibration.
- Install the condensing unit in such a place from which hot air distributed from it does not annoy your neighbours.
- Be certain that there is no object which interrupts the air way from the condensing unit, because this may cause noise and reduction of capacity.
- If any abnormal noise comes out of the air conditioner, consult your Daikin dealer.

■ Electric wiring

- Confirm that an exclusive power circuit is provided for the air conditioner.

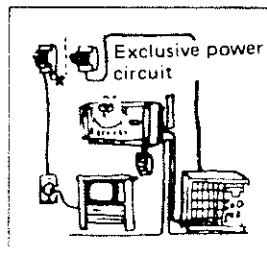

- * (1) Be sure to provide an exclusive power circuit for the air conditioner; if not, fuse or circuit breaker may be sometimes blown off.
- (2) Do not provide multi-wiring, as it may cause fire.

- Confirm that there is no object which may damage wiring and piping.

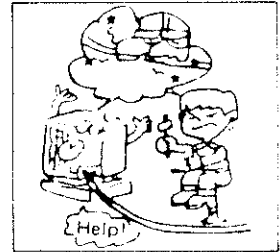

- Confirm that the earthing is provided from the condensing unit.

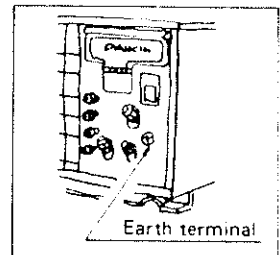

- * If the earthing is provided on the water pipe or gas pipe, there is fear of electric shock to persons who use water, or of explosion.

- Confirm that a leak breaker is attached.
- * In certain cases depending on installation positions, a leak breaker should be attached.

PROHIBITIVE ITEMS:

Carefully read the following so that the air conditioner can be used safely.

- Do not sprinkle water directly over the fan coil unit and remote control unit to clean them. In addition, be careful not to wet inside the fan coil unit with spilled water.

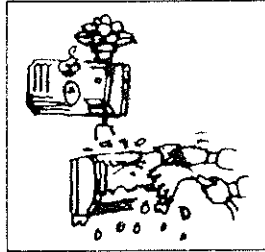

* If it is operated in wet condition, there is fear of electric shock or catching fire.

- Do not cut the remote control unit cord short.
 - * This over-heats the air conditioner, which may cause catching fire.

- Do not cover a ventilation opening of the remote control unit. In addition, do not cover its bottom.

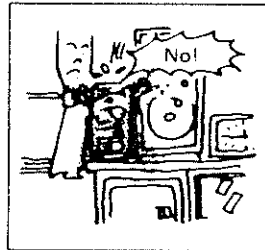

* If air ventilation to the remote control unit is prevented, this may cause erratic operation.

- Do not insert a thing into the ventilation opening of the remote control unit.

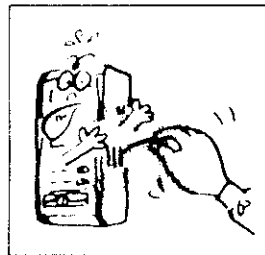

* It is because there is fear of electric shock.

- Do not insert a small bar or a finger into the air suction inlet or the air discharge outlet during the operation.



* It is very dangerous especially for children to touch the fan rotating in high speed.

- Do not use a wire or copper wire instead of fuse.

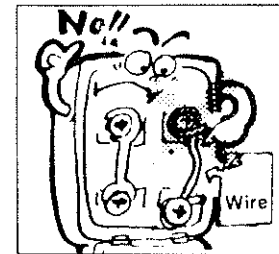

* Replace blown fuse with fuse having correct ampere, otherwise the air conditioner may be out of order or there is fear of catching fire caused by over-heating.

- Do not inspect or maintain the air conditioner during operation.

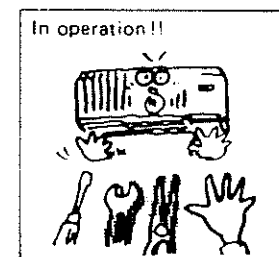

* There may be fear of electric shock or touching the rotating fan.

(Before inspection or maintenance, confirm that the operation knob is set at [OFF] and the exclusive power supply is disconnected from the main switch.)

CAUTION FOR OPERATION

Observe the following items for correct operation.

- Confirm that the air filter is attached before operation. Further, clean the air filter once in two weeks.

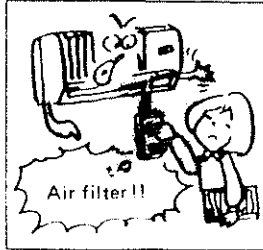

- * If the air conditioner is operated without the air filter, dust in the room air cannot be removed, cooling (or heating) efficiency is reduced, and the internal components are stained by dust, which may cause trouble.

- Do not hang from the fan coil unit.

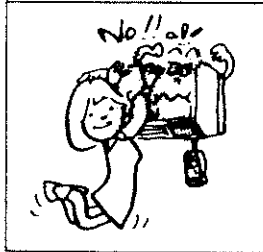

- Do not pull the remote control unit cord forcibly.



- * If it is pulled forcibly, the cord is not only damaged but also burnt out. In addition, this may cause electric leakage.

- Adjust the air direction not to direct cool air to human bodies for a long time. Before going to bed, it is advisable to set the blades of the discharge grille horizontally.

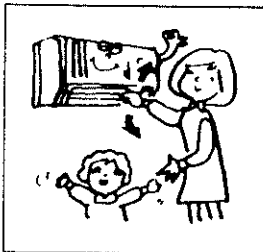

- * Subject to constant cool air draft, one may catch a cold.

- Note that small animals and plants may be affected by direct distributed air for a long time.

- Carefully adjust room air temperature for handicapped persons, infants, children, old aged or sick persons.

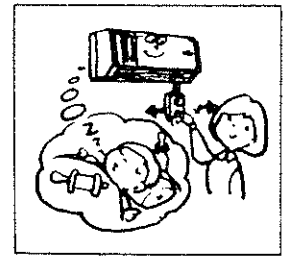

- Do not use flammable spray such as hair spray, lacquer paint near the air conditioner.

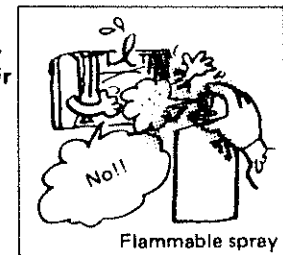

- * This may cause catching fire.

- Confirm that remote control unit cord is not damaged by sharp edge or between furniture.

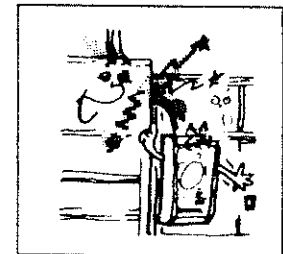

- * If the cord is damaged, there may be fear of burning or electric leakage.

- Do not place any obstacle which obstructs the air way from the air distribution outlet during operation.

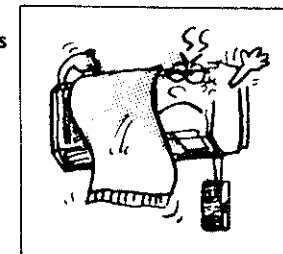

- * This not only reduces cooling (or heating) capacity, but also becomes cause of trouble.

- When the air suction inlet and the air distribution outlet of the condensing unit are covered with snow, do not operate it.

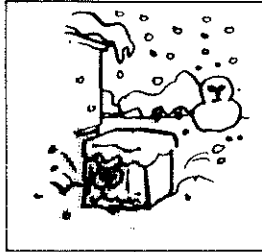

* This may cause trouble.

- In such a district where outdoor temperature continues under 0°C for a long time, do not connect a drain hose to the condensing unit.

* This is because water in a drain hose is frozen, and water condensation does not come out smoothly.

- When electricity is interrupted during operation, turn off the master control switch.

- Be sure to turn off the master control switch and disconnect the exclusive circuit breaker for air conditioner before prolonged idle period. However, since the crankcase heater is turned on automatically in very cold outdoor temperature, do not disconnect the circuit breaker during heating season.

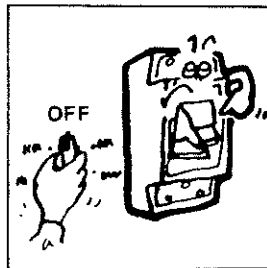

- Do not put the heated materials close to remote control unit cord.

* If the remote control unit cord is heated, there may be fear of burning or electric leakage.

- In the following cases, stop the air conditioner at once and disconnect the circuit breaker. Then contact your Daikin dealer.

- Remote control unit cord is abnormally hot. (It cannot be touched by hand).
- Coat of the remote control unit cord is peeled off.
- Safety devices function frequently or function of the master control switch is inaccurate.

RECOMMENDATION FOR ECONOMICAL OPERATION IN POWER CONSUMPTION

Compared with other electric devices, power consumption of an air conditioner is large. The following operation methods are recommendable for economical power consumption.

- **Adjust the temperature setting so as not to cool the room excessively. (cooling)**

If the temperature difference between indoors and outdoors is excessive, you will on the contrary feel uncomfortable. For your health, temperature difference between indoors and outdoors should be maintained at approximately 5°C .

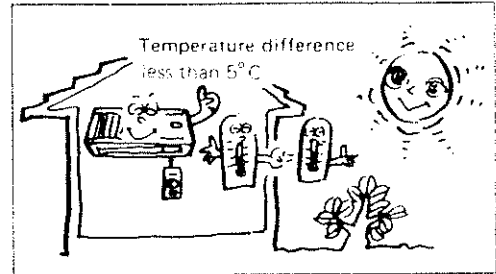

- **Draw the curtains or the blinds on the window from which direct sunlight comes into the room. (cooling)**

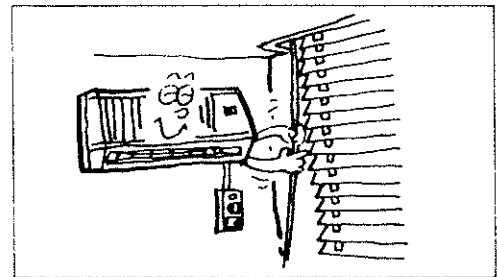

- **Do not leave a window or door open.**

When a window or door is left open, the cool (warm) air slips away from the opened window or the door, which reduces cooling (heating) efficiency. In case room air is polluted, for instance by a gas cooking stove, etc., slightly open a window to ventilate stale room air.

- **Clean the air filter once in two weeks.**

OPERATING CONDITIONS

To maintain top efficiency of the air conditioner, observe the following conditions.

- The circuit breaker used in the power supply should be as follows.

RSY32HVEIF	20 ampere (maximum)
RSY56HVEIF	50 ampere

- Limit of voltage (Voltage during the operation)

Rated voltage		Limit of voltage fluctuation
220V	50/60Hz	198~242 volt
230V	50/60Hz	207~253 volt
240V	50Hz	216~254 volt

(In case power source ampere is insufficient or voltage is out of the range, cooling capacity is reduced, fuse or circuit breaker is blown off, or life of the air conditioner is extremely shortened.)

- Air conditioner should be operated within the following range of temperature and humidity.

Operation	Outdoor temperature	Indoor temperature	Indoor humidity			
Cooling	(Approx. over 21°C and under A When it is approx. over A safety device may stop cooling operation.	(Approx. over 21°C and under 32°C) If air conditioner is operated for a long time under room temp lower than approx. 21°C, frost gathers and stops cooling operation.	(Approx. under 80%) When air conditioner is operated for a long time under humidity over 80%, dew forms on the casing and drops on the floor. So do not place anything which should be free from water there.			
	<table border="1" style="width: 100%;"> <tr> <th>Condensing unit</th> <th>A (Max, temp)</th> </tr> <tr> <td>RSY32HVEIF</td> <td>50°C</td> </tr> <tr> <td>RSY56HVEIF</td> <td>46°C</td> </tr> </table>			Condensing unit	A (Max, temp)	RSY32HVEIF
Condensing unit	A (Max, temp)					
RSY32HVEIF	50°C					
RSY56HVEIF	46°C					
Heating	(Approx. -5°C~21°C) When it is over 21°C, safety device stops heating operation. In case it is under -2°C, capacity may reduce depending on size of rooms.	(Approx. under 24°C) When it is approx. over 24°C, safety device may stop heating operation.				

NAME AND FUNCTION OF COMPONENTS

In case of the split type air conditioner, the fan coil unit (the evaporator and the fan) should be connected to the condensing unit (the compressor and the condenser)

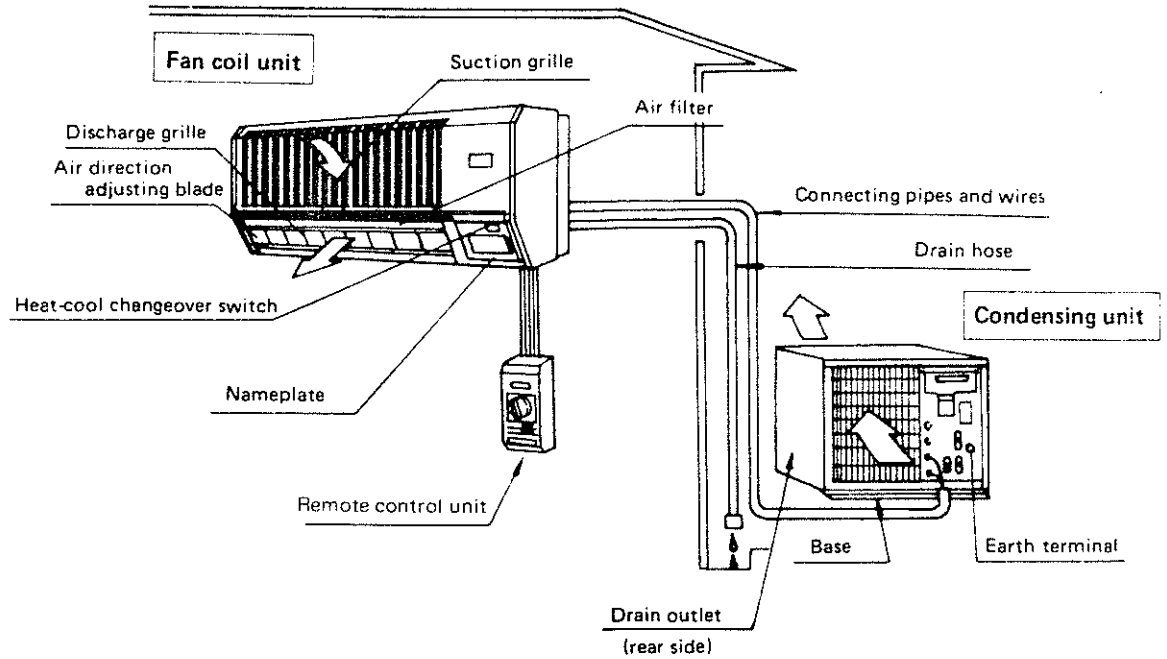

● Function of each component

- ◆ Air discharge grille Direct the cool or warm air up and down by rotation of the grille, left or right by the air adjusting lever.
- ◆ Air suction grille The air filter is attached inside to remove dust from the room air when it is drawn in.
- ◆ Control panel of the unit ... Heat-cool change-over switch.
- ◆ Remote control unit Master control, fan control, thermostat, heater can be controlled manually.
- ◆ Drain hose Extract water removed from the room air by cooling operation.
- ◆ Earth terminal Connect with earthing wire to protect against electric shock.
- ◆ Base When the condensing unit is fixed, use holes on the base.
- ◆ Drain outlet This is an outlet for rain water or dew collected in the condensing unit.

FUNCTION OF CONTROL PANEL

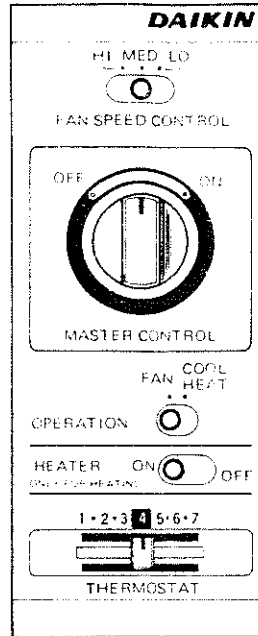

● Function of each component

◆ Heat-cool changeover switch

- [COOL] for cooling operation
- [Heat] for heating operation

◆ Master control switch

- [ON] Start the unit.
- [OFF] Stop the unit.

◆ Fan speed control switch

- [HI] When rapid and powerful cooling (heating) or rapid air circulation is required. (Maximum air flow)
- [MED] When normal cooling (heating) or normal air circulation is required. (Medium air flow)
- [LO] When quiet cooling (heating) or quiet air circulation is required, particularly during night. (Minimum air flow)

- ◆ **THERMOSTAT** When the room temperature becomes preset temperature of the thermostat, this stops the condensing unit automatically.
When the room temperature rises higher (or drops lower) than preset temperature, this operates the condensing unit again automatically.
Room temperature is maintained higher in accordance with thermostat setting toward smaller numbers to [1] and lower toward larger numbers to [7].

◆ OPERATION

- [FAN] Fan is operated to room-air circulation.
- [COOL
HEAT] For cooling or heating operation.

◆ HEATER

- [ON] For heating with Flon Heater.
- [OFF] For heating without Flon Heater.

OPERATION ORDER

1. Cooling operation

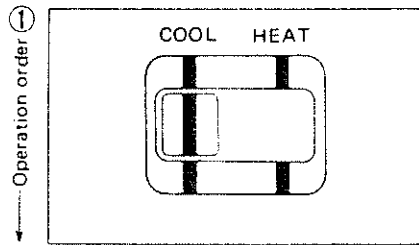

- Set the heat-cool changeover switch at the [COOL] position.

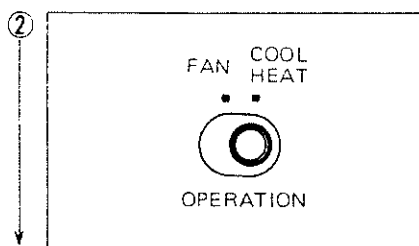

- Set the [Operation] switch at [COOL] position.

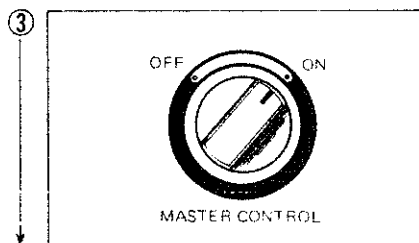

- Set the Master Control switch at [ON] position.

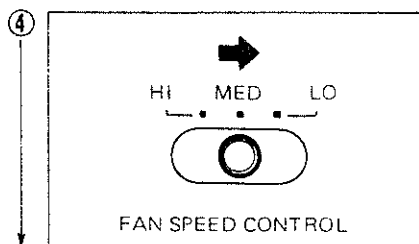

- Set the fan speed control switch at a desired position.
 - [HI] When rapid and powerful cooling (heating) or rapid air circulation is required. (Maximum air flow)
 - [MED] When normal cooling (heating) or normal air circulation is required. (Medium air flow)
 - [LO] When quiet cooling (heating) or quiet air circulation is required, particularly during night. (Minimum air flow)

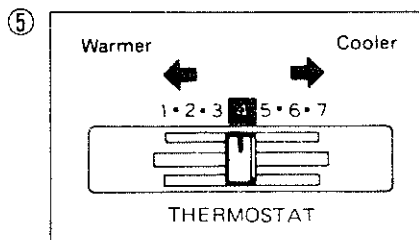

- Set the thermostat indicator at a desired location.
 - Normally set it at 4. (Practically suitable temperature for most persons)
 - One graduation changes temperature by approximately 2°C.
- Note:** Since comfortable temperature differs with persons and room conditions, if room temperature is uncomfortable when the indicator is set at 4, adjust it as you like.

2. Heating:

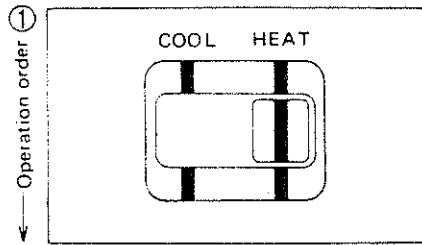

- Set the heat-cool changeover switch at [HEAT] position.

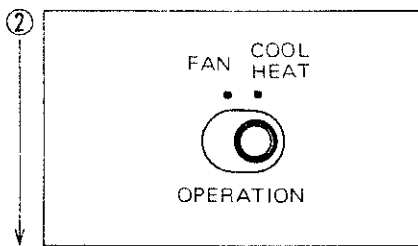

- Set the [OPERATION] switch at [COOL/HEAT] position.

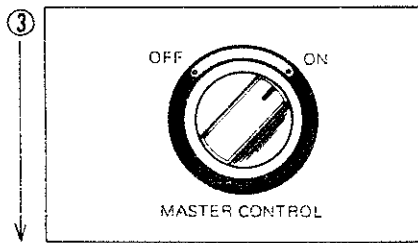

- Set the Master control switch at [ON] position.

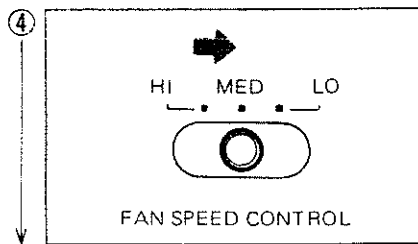

- Set the fan speed control switch at a desired fan speed.
 - [LO] When quiet heating or quiet air circulation is required particularly during night. (Minimum air flow)
 - [MED] When normal heating or normal air circulation is required. (Medium air flow)
 - [HI] When rapid and powerful heating or rapid air circulation is required. (Maximum air flow)

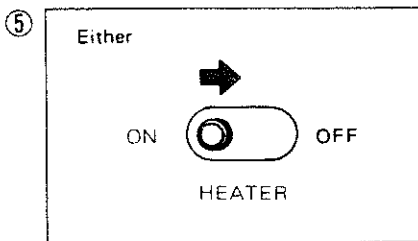

- Set the thermostat indicator at desired location.
- Set the heater switch either at ON or OFF.
 - [OFF] When normal heating is required.
 - [ON] When powerful heating is required.

Note: When outdoor temperature drops, set the heater switch at [ON] position to shorten the time defrosting.

[Caution]

- (1) If the air conditioner is operated as stated below, cooling (or heating) the air conditioner does not come into by the function of the safety start circuit. At this time, approximately 3 minutes later, it will come into cooling (or heating) operation automatically.
 - When the air conditioner is restarted immediately after it was stopped.
 - When the air conditioner is restarted by changing thermostat setting immediately after it was stopped by the function of the thermostat.
 - When the heat-cool changeover switch is switched-over repeatedly.
 - When the master control switch is turned on and off repeatedly.
- (2) At the start of heating operation, the air conditioner is operated with low fan speed until distributing air temperature reaches a certain temperature. The same phenomenon takes place after the thermostat has functioned, but this is not due to trouble. (In addition, heating operation with low fan speed is changed to that with high or medium fan speed or vice versa and this is sometimes repeated under very cold ambient temperature, but this is not due to trouble.)
- (3) In case of heating, if outdoor temperature drops, frost gathers on the heat exchanger of the outdoor unit. This reduces heating capacity. Therefore, defrosting starts automatically. **At this time, both outdoor and indoor fans stop and no draft comes out of either unit. This phenomenon is normal.**
- (4) In case of heating, the outdoor unit is frozen depending on outdoor temp. This phenomenon is apt to be seen during defrosting operation.

3. Fan operation

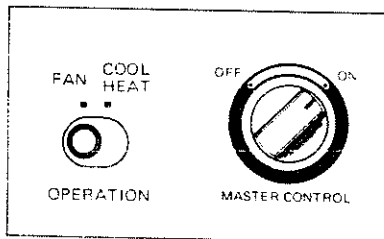

- (1) Set the [OPERATION] switch at [FAN].
- (2) Set the fan speed control switch at either HI, MED or LO.
- (3) Set the [MASTER CONTROL] switch at ON, and the fan starts running.

4. Stoppage

■ All functions stop.

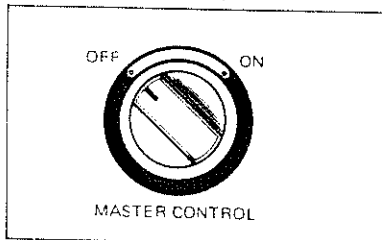

- Operation is stopped at once.
The [MASTER CONTROL] switch is OFF.

6. Air direction adjustment (Adjust air direction as stated below during cooling or heating)

(Up and down adjustment)

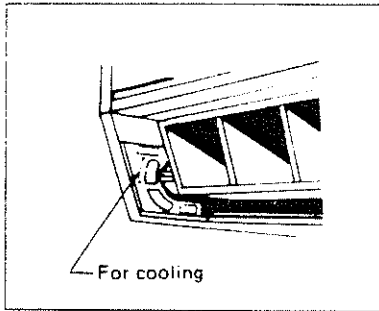

Cooling

- Set the grille one step higher than horizontal line (Cooling position)
(If the grille is set at heating position, dew forms on the air discharge grille and drops on the floor eventually.)

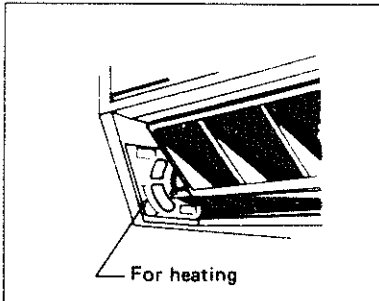

Heating

- Set the grille two stages from the horizontal line. (Heating position)

(Right and left adjustment)

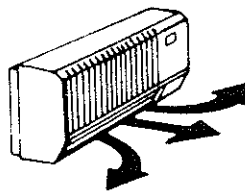
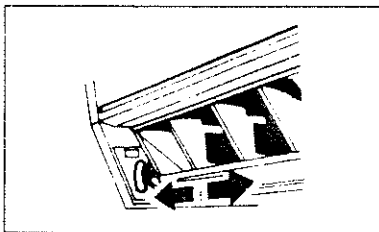

- When controlled warm or cool air is desired to be directed to left or right, move the air direction adjusting valve to left or to right.

([The blades on the left-side half are for directing controlled air to the left and the ones on the right-side half are for directing it to the right.])

EFFECTIVE OPERATION FOR MULTI-ROOM AIR CONDITIONERS

The Daikin multi-room air conditioners are capable of connecting from two to three fan coil units with a single condensing unit and of cooling and heating from two to three rooms by using capacity of the condensing unit most effectively. Each fan coil unit connected can be operated simultaneously or independently. When they are operated simultaneously, cooling and heating capacities of each fan coil unit are reduced. However, this capacity reduction can be compensated for temperature fluctuations or living pattern of a family. Consequently, the multi-room air conditioner can be operated effectively and most economically with its fan coil units in operation simultaneously or independently in accordance with seasons, outdoor temperature and structure of a room.

Capacities of the heat-pump type multi-room air conditioner (for two rooms) when both fan coil units are in operation and a fan coil unit is in operation.

Condensing unit for two room application RSY32HVEIF x 1 unit
 Wall-mounted type fan coil units FTY22JVEIF x 2 units

Independent cooling
 (a room) – during daytime

Cooling

Simultaneous cooling (two rooms) – during night

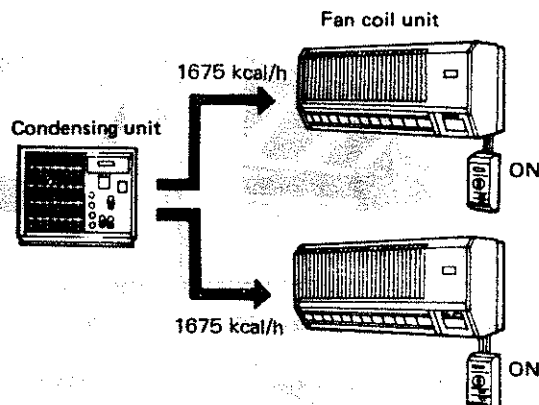
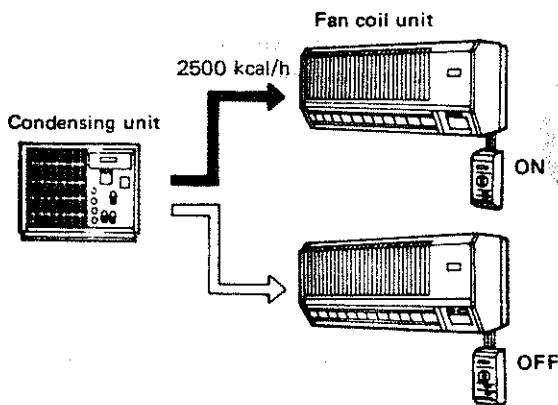

Indepe
 (a room)

Condensi



Notr

1. C
 ce
 se

2. W
 b.
 t.
 o.
 3. A
 p
 o.

Independent heating
(a room) – during night

Heating

Simultaneous heating (two rooms) – during day time

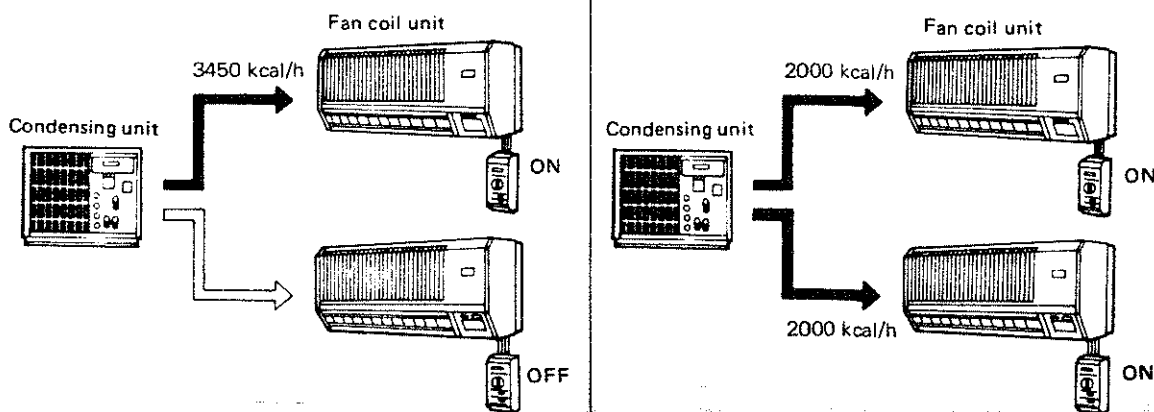

Notes:

1. Cooling and heating cannot be accomplished simultaneously by a single multi-room air conditioner. So do not put one fan coil unit in heating and the other in cooling. This may cause serious trouble.

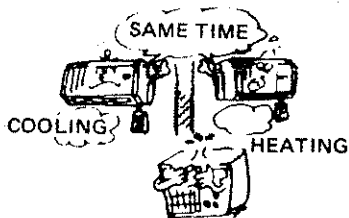

(During heating operation, if one fan coil unit is put in cooling operation, all the other fan coil units connected are put in cooling operation; i.e. the fan coil unit which has been in heating operation is turned in cooling operation with low fan speed.)

2. When two fan coil units come in heating operation simultaneously, period for low fan speed becomes longer than that when a single fan coil unit is in heating operation. Therefore, it is advisable to operate one fan coil unit first until its fan speed turns from low to HI, and then operate the other for quick heating.
3. Although the fan coil units are operated in sequence as stated above, if low fan speed period is prolonged, heating capacity of the multi-room air conditioner must be insufficient. In this case operate only one fan coil unit.

MAINTENANCE

When the air conditioner is inspected or maintained, be sure to stop the operation and disconnect the power supply.

■ Cleaning the air filter

Clean the air filter before and after the operation season and once in two weeks during the operation. If the air filter is kept uncleaned, the flow rate is reduced, which in turn reduces cooling (heating) capacity.

- Be sure to stop the unit before removing the air filter, because dust is scattered away when the air filter is pulled out while operating.
- When the unit is operated for a long time under high humidity, dew may form on the air filter, there may be fear of dew dropping on the floor, if you pull out the air filter without any care.

- (1) Pull the air filter knob and pull it downwards.

(Set the discharge grille horizontally when pulling out and pushing in the air filter.)

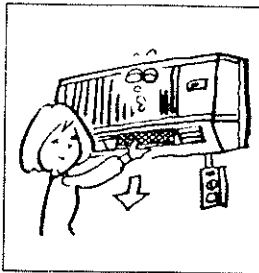

- (2) Wash away dust from the filter or suck up dust by an electric cleaner. When it is washed, dry it out.

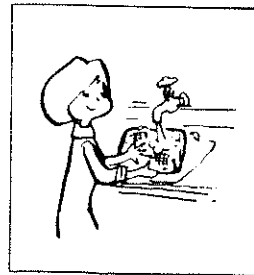

- (3) After cleaning it, put back the air filter as it was.

Do not operate the air conditioner without the air filter.

Without the air filter, air filtering efficiency is eliminated, cooling capacity may be reduced or trouble may occur due to dust stained on the machine.

◀ Notes ▶ :

- Do not wash the air filter with hot water higher than 50°C, because it may shrink.
- Do not dry the air filter directly by fire, because it may burn.
- Do not dry the air filter in sunshine for a long time, because it may shrink.
- In case the air conditioner is used in dusty place, frequently clean it.

■ Cleaning the front grille.

Do not sprinkle water over the front grille to clean it. Dust it or wipe it lightly with a soft and dry cloth. If it is difficult to remove dust, wipe it with a soft cloth dipped in water.

- Do not use hot water higher than 50°C, as it may be deformed or causes colour change.

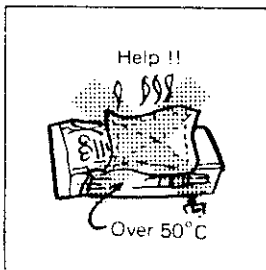

- Do not use benzene, gasoline, thinner, polishing powder, machine oil, or liquid insecticide for the air conditioner, because paint will peel off and casing will crack or be deformed.

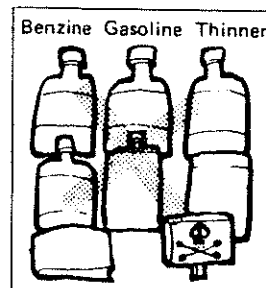

■ Inspection and maintenance

Although staining degree of air conditioners differs with using conditions, it is advisable to inspect and maintain them regularly. Inspection and maintenance can be accomplished by your Daikin dealer on request. In this case, however, actual expenditure for that service should be charged you.

MAINTENANCE BEFORE AND AFTER PROLONGED IDLE PERIOD

1. Maintenance before the operation season

- Check if the earthing wires are disconnected or have come off. If anything unusual is found, contact your Daikin dealer.

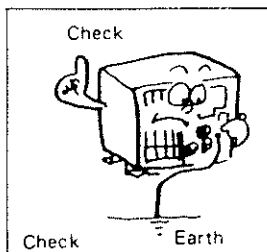

- Check if the air way from the air inlet and outlet of both fan coil and condensing units is not interrupted by obstacles. Remove obstacles.

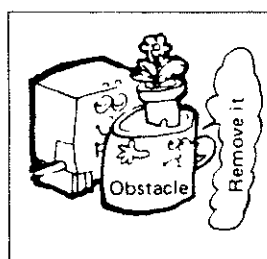

- Connect a circuit breaker exclusively for power supply to room air conditioners.

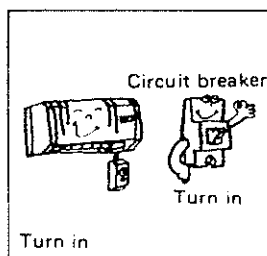

- In case overhaul is required when room air conditioners are stained after 4 ~ 5 year use, ask your Daikin dealer.
- Be certain that the installation base is not corroded or rusted and has a sufficient strength to support the air conditioner. If anything unusual is found, contact your Daikin dealer.

2. Maintenance after the operation season

- Operate the fan alone for half a day on a fine day to dry the internal part.

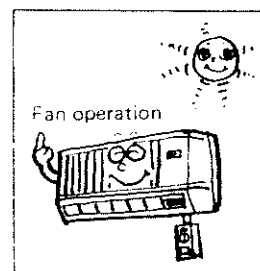

- Disconnect the circuit breaker exclusively for power supply to room air conditioner.

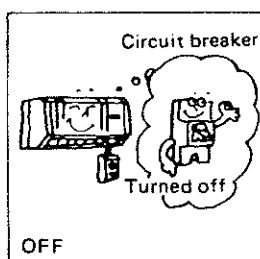

- After having cleaned the air filter, put it back as it was in the air conditioner. (See the article "Cleaning the air filter")

INSPECTION BEFORE CALLING AFTER-SALES SERVICE

When the air conditioner does not work well, inspect the following items.

If the air conditioner still does not work well, inform your Daikin dealer of (1) MODEL NAME (2) MFG. NO. and (3) state of trouble.

■ The air conditioner is completely inoperative.

● Check if the circuit breaker or the fuse is blown.

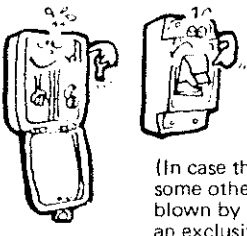

Set the Master control switch on the control panel at OFF and turn on the circuit breaker or replace the fuse with a new one.

(In case the electric circuit is used with some other electric device, it may be blown by determined ampere. Provide an exclusive electric circuit for air conditioner.)

● Check if the master control switch is set at OFF position.

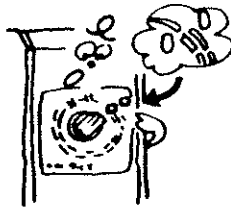

Turn the knob at ON position.

● Check if [safety start circuit] has functioned.
(See the page 12)

● Check if power is interrupted.
Set the Master control switch at OFF and wait until electricity is recirculated.

● Check if one of the safety devices has functioned.

● In case of cooling
When outdoor temperature rises over 46°C, the safety device will come into operation and stop cooling operation.
(1) Confirm that there is not object which interrupts the air way in and out of the condensing unit.

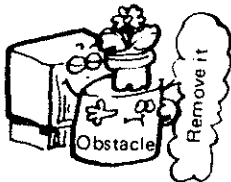

● In case of heating
When outdoor temperature becomes over 21°C and room temperature over 24°C, the safety device will come into operation and stop heating operation.
(1) Confirm that there is no object which interrupts the air ways in and out of the condensing unit and fan coil units.



After having confirmed that no object is in the air ways stated in (1), set the Master control switch at OFF and wait for few minutes. Then start it again. (Once the safety device has functioned, the air conditioner may sometimes not come into operation after lapse of several minutes when the Master control switch is set at OFF.)



■ The air conditioner is operative, but cooling (heating) capacity is insufficient.

● Check if the air filter is clogged.

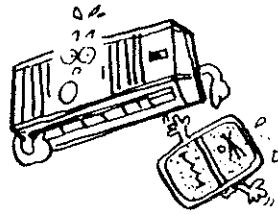

Make air circulation smoothly.

● Check if a window or the door is kept open.

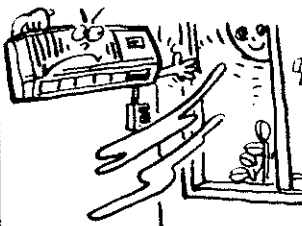

Shut a window or the door to prevent the cool air from slipping away.

- Check if the thermostat knob is set near to 「1」 ~ 「2」 (「6」 ~ 「7」 in case of heating)

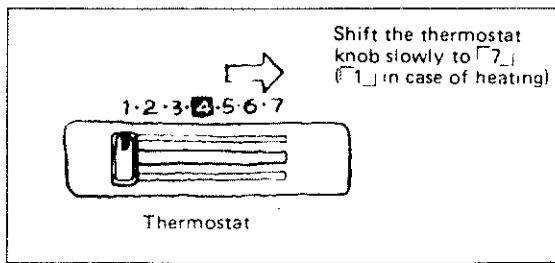

- Check if there is a heat source in the room. (Check if an electric heater or gas stove is used in the room.)

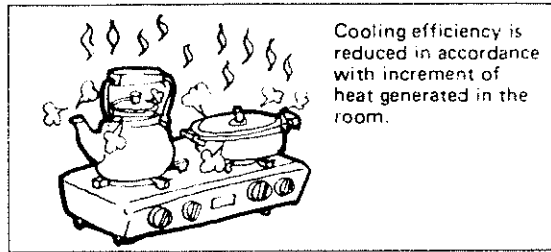

- Check if the air inlet or the air outlet of both fan coil and condensing units are blocked by obstacles.

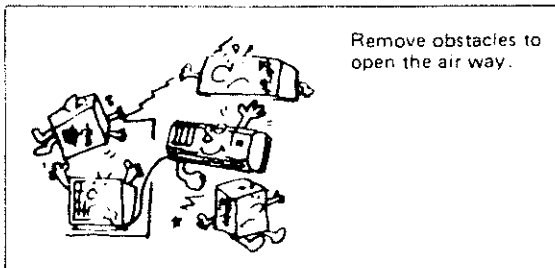

- Check if there are too many people in the room.

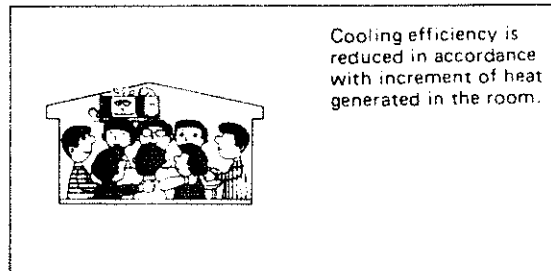

- Check if the fan speed control knob is set at LO.

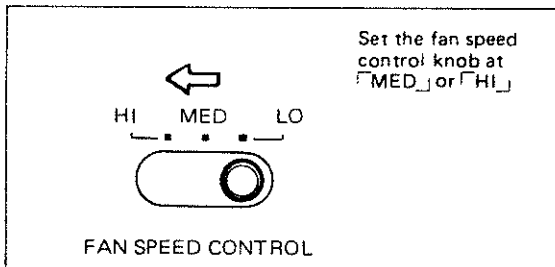

■ The following noises are not abnormal.

- Noise of Shru shru . . . and ZU . . . immediately after operation starting and stopping.
 - This is noise for flowing gaseous refrigerant as state of the air conditioner is not stable immediately after its stopping and starting.
- Noise of Pshshsh . . . after stopping and during heating operation
 - This is noise given out when the refrigerant flow is stopped or changed.
- Noise of "Zu . . ." immediately after operation starting and functioning of the thermostat.
 - This is noise given out when the compressor starts running. However, this noise becomes low in a minute.
- Continuous "Shu . . ." noise when the air conditioner is operated with low fan speed.
 - This is noise given out when the gaseous refrigerant flows.
- Noise of click after a little while when timing count is completed.
 - This is noise given out when the timer counting is completed.
- Continuous noise of Shu . . . given out of the condensing unit in operation under high outdoor temperature.
 - This is noise given out when the control valve has functioned.
- Noise of "tititi" during operation, and after operation starting and stopping.
 - This is noise given out when the internal switch functions.

If other noises rather than those stated above are heard, contact your Daikin dealer.