

---

# Owner's Manual

---

*Using the  
Ducted Gas Central Heating  
Add-on Refrigerated Air Conditioning  
Ducted Evaporative Air Conditioning*

*with your*

## **multi-appliance Comfort Control**

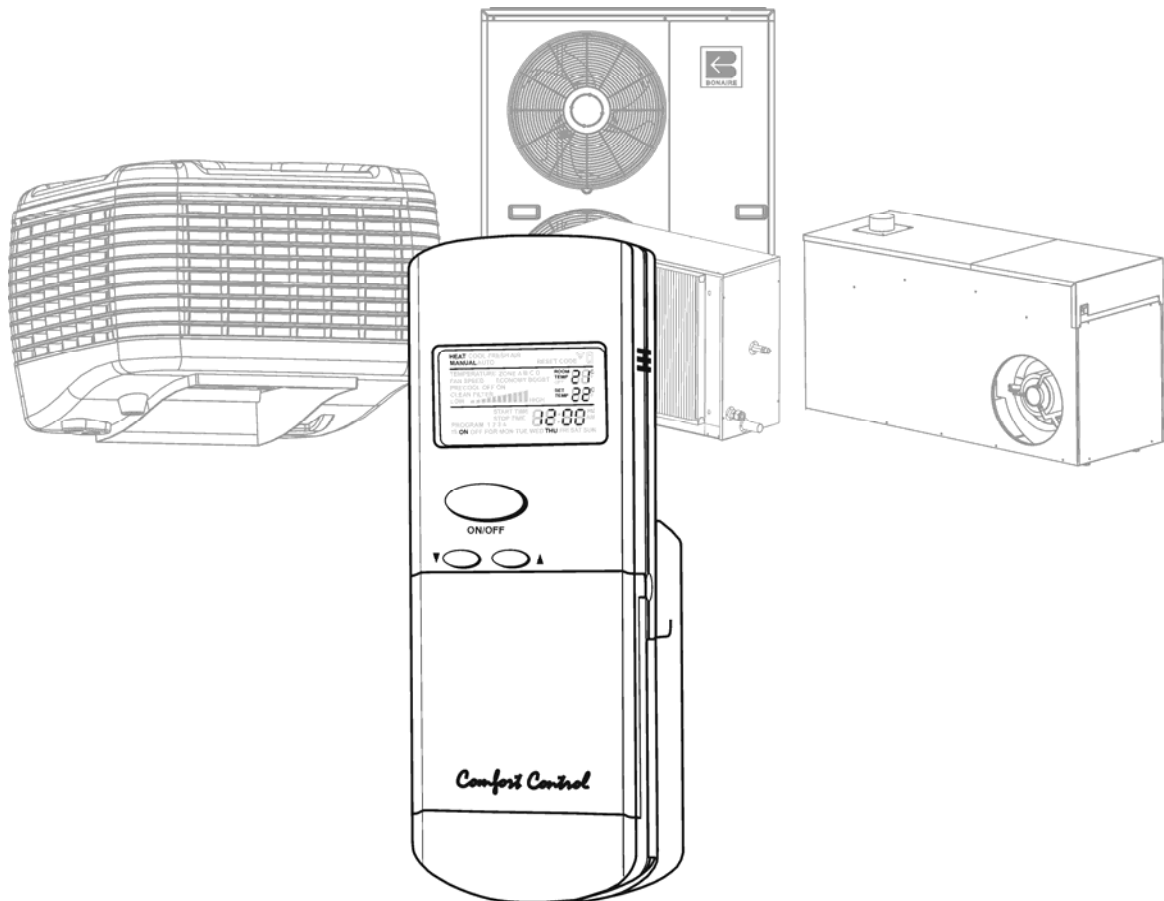

### ***Radio Frequency & Low Voltage***

Please keep this important manual in a safe place. It is the owner's responsibility to ensure that regular maintenance is carried out on this Ducted Evaporative Air Conditioner. Failure to do so will void all guarantees beyond statutory and legal requirements.

[www.climatetechnologies.com.au](http://www.climatetechnologies.com.au)

**Contents**

---

<b>INTRODUCTION.....</b>	<b>4</b>
YOUR MULTI-APPLIANCE COMFORT CONTROLLER.....	4
GENERAL INFORMATION.....	5
Important Installation Notice.....	5
Data Location.....	5
Warranty.....	5
<b>NAVIGATING THE CONTROLS.....</b>	<b>6</b>
QUICK START.....	6
QUICK START - SIMPLE MANUAL OPERATION.....	6
The Comfort Controller.....	8
THE LCD DISPLAY.....	8
USING THE 9 BUTTONS.....	9
SETTING DAY AND TIME.....	11
<b>DUCTED GAS CENTRAL HEATING.....</b>	<b>13</b>
GENERAL INFORMATION.....	14
Important Notice.....	14
Data Location.....	14
Assembly.....	14
SAFETY.....	15
Safety & Owner Responsibility.....	15
Precautions.....	15
Features.....	15
Power or Gas interruption.....	15
USING YOUR COMFORT CONTROL.....	16
Manual Operation.....	16
ECONOMY & BOOST for heating.....	17
Summer Fan.....	17
ZONES - Selecting ABCD options.....	18
Optional Summer Shutdown.....	18
First Startup or Restart After Shutdown.....	18
Auto Mode.....	19
Programming Your Comfort Control.....	19
HEATER MAINTENANCE.....	21
SCHEDULED MAINTENANCE.....	21
PROBLEM SOLVING.....	22
<b>ADD-ON REFRIGERATED AIR CONDITIONING.....</b>	<b>23</b>
GENERAL INFORMATION.....	24
Important Notice.....	24
Data Location.....	24
Assembly.....	24
SAFETY.....	24
Safety & Owner Responsibility.....	24
Precautions.....	24
Features.....	24
Power interruption.....	24
COMFORT CONTROL.....	25
Manual Operation.....	25
ZONES - Selecting ABCD Options.....	26
Fan Operation.....	26
Programming Your Comfort Control.....	26

**Contents**

Using the Programming Sequence ..... 26

**DUCTED EVAPORATIVE AIR CONDITIONING ..... 27**

INTRODUCTION ..... 28

UNIT OPERATION ..... 28

    Exhaust ..... 28

    Water Management ..... 29

    Comfort Control – Quick Reference..... 30

USING YOUR COMFORT CONTROL..... 31

    Manual Mode ..... 31

    Auto Mode (Thermostat)..... 31

    BOOST..... 32

    TIMER MODE ..... 32

    PRECOOL ON/OFF..... 33

    Filter Cleaning..... 33

Ducted Evaporative Air Conditioner Maintenance ..... 34

    General. .... 34

    Filter Pads..... 34

    Water Tank ..... 34

    Water Level / Float Valve..... 34

    Motor and Fan..... 35

    Electrical ..... 35

    Bleed Off ..... 35

    Pump..... 35

    Water Distribution ..... 35

    No Seasonal Maintenance..... 35

**CONTROL SETUP ..... 38**

    SETTING UP THE CONTROL - GENERAL ..... 38

        Installation..... 38

        Coding The Unit..... 39

        Checking The Signal – RF Remote Control Only..... 39

        Changing the Code..... 39

    SETTING UP THE CONTROLS – DUCTED GAS CENTRAL HEATING..... 40

        Setting Minimum Fan Speed ..... 40

        Setting Maximum Fan Speed ..... 40

        Setting The Zone Availability ..... 40

    SETTING UP THE CONTROLS – DUAL CYCLE REFRIGERATED AIR CONDITIONING..... 41

        Setting the Fan Control from Continuous to Auto Mode..... 41

        Setting the Fan Control from Auto to Continuous Mode..... 41

        Setting Minimum Fan Speed ..... 42

        Setting Maximum Fan Speed ..... 42

        Setting The Zone Availability Filter ..... 42

    SETTING UP THE CONTROLS – DUCTED EVAPORATIVE AIR CONDITIONING ..... 43

        Setting Minimum Fan Speed ..... 43

        Setting Maximum Fan Speed ..... 43

        Setting up the Dump Valve (Where Fitted)..... 44

    COMMISSIONING CHECK LIST ..... 45

**WARRANTY ..... 47**

**SERVICE..... 51**

**Introduction**

---

**YOUR MULTI-APPLIANCE COMFORT CONTROLLER**

*You have chosen one of the world's most advanced comfort control systems incorporating the latest technology.*

*Your Comfort Control has been designed to operate various Climate Technologies products:*

**Heating** – 3, 4, 5 Star Ducted Gas Central Heaters.

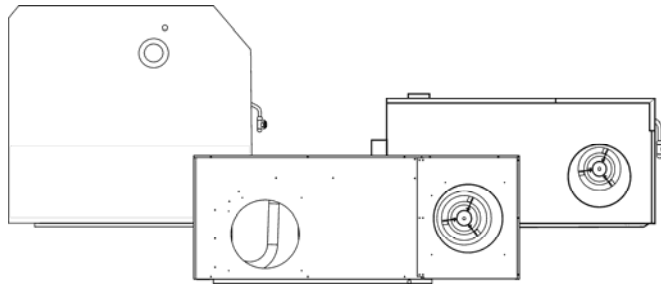

**Dual Cycle Cooling** - Refrigerated Air Conditioning (cooling only) designed to Dual Cycle to Ducted Gas Central Heaters.

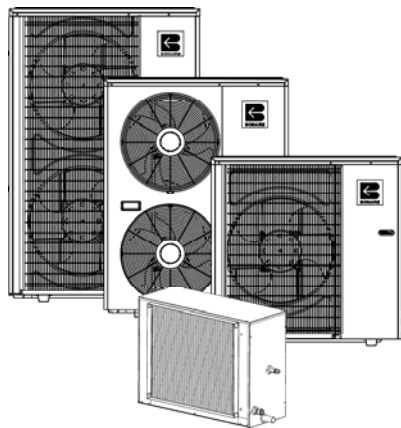

**Fresh Air Conditioners** - Ducted Evaporative Air Conditioners.

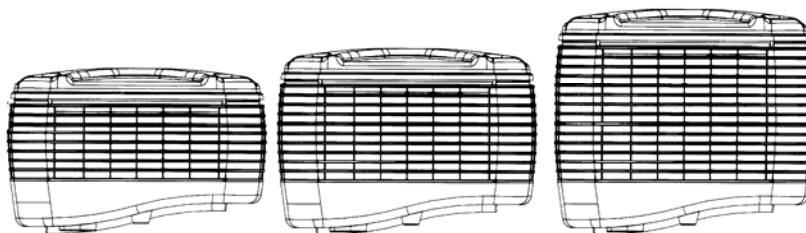

## Introduction

---

*Your Comfort Controller is designed to automatically detect the appliances during the commissioning of the unit by the installer. Controller options not required for your appliances will usually not be visible on your Comfort Control display.*

*Whether hand held or wall mounted take advantage of the versatility your Comfort Controller offers.*

*Use your Comfort Controller to reduce your energy bills by selectively conditioning part or your entire home at an economical reduced rate or by setting programs to suit your needs.*

*Your Comfort Control is designed in Australia to suit Australian conditions and will ensure that your home is comfortable all year round.*

### **GENERAL INFORMATION.**

#### **IMPORTANT INSTALLATION NOTICE.**

A licensed person is required to install Climate Technologies equipment. If the equipment is not installed in accordance with the installation instructions and the governing body regulations, Climate Technologies reserves the right to refuse service on non compliant installations.

Subject to state regulations and by laws a certificate of compliance must be issued for the electrical and plumbing connections certifying that the work complies with all the relevant standards.

Note: Only a licensed person will have insurance protecting their workmanship.

#### **DATA LOCATION.**

Your appliance model number, serial number and model description are located on the appliance data plate on the end of the heater or inside the cooler in the vicinity of the electronic controls. These details should also be in the warranty section of this booklet.

You will need this information, should your appliance require servicing, spare parts or just if you require additional information about this product.

#### **WARRANTY**

Warranty service work must only be carried out by Climate Technologies service division or its authorised service providers. See warranty section.

### **Text and Illustration Copyright Climate Technologies 2005**

All rights reserved. No part of this document may be reproduced or transmitted in any form or by any means, electronic or mechanical, including photocopying, recording or by any information storage and retrieval system, without prior permission in writing from Climate Technologies

In the interest of continued product improvement Climate Technologies reserves the right to alter specifications without notice. E.&O.E.



## Navigating the Controls

### QUICK START

#### First - the 15 second delay

To give you time to choose your settings the Comfort Control pauses 15 seconds then sends its signal to your Heater/Cooler. So don't worry if something doesn't happen immediately.

Watch for the transmit symbol  at the top of the screen. This means that the signal has been sent.

If you don't want to wait, pressing and releasing the ENTER button sends your settings immediately. (You don't need to do this when using ON/OFF.)

#### Second - What you'll see is what you've got

Your Comfort Controller is designed to automatically detect the appliances you have installed. Controller options not required for your appliances will usually not be visible on your Comfort Control display. So don't worry if you don't see all the menu items listed in this book.

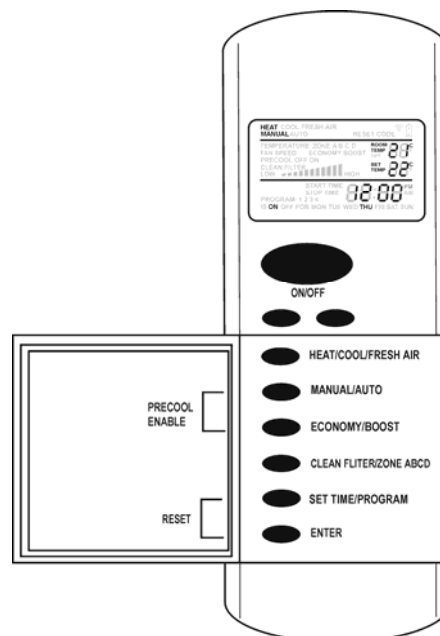

### QUICK START - SIMPLE MANUAL OPERATION

Here's all you have to do to get going (if the installer hasn't already done it for you).

1. If you have a Radio Frequency comfort control make sure the 3 new AAA alkaline batteries have been fitted (see page 6). The wall mounted comfort control gets its power from a cable.
2. Press and release the ON/OFF button until ON appears at the bottom of the display screen.
3. Press & release the **HEAT/COOL/FRESH AIR** button (inside the flip open door) to select the appliance. The choices available will be dependant on the appliances you have installed. Press **MANUAL/AUTO** to select MANUAL.
4. Press ▼ or ▲ buttons to choose the desired setting.

Your unit will now operate in manual mode.

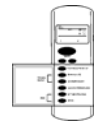

## Navigating the Controls

### IDENTIFY YOUR COMFORT CONTROL MODEL

Use these pictures to identify which model you have.

#### *WALL MOUNTED*

This model is mounted permanently in the cradle on your wall. No batteries are required. Power is supplied via the same cable that takes the controller's signals to your heating and / or cooling appliances.

#### *HAND HELD RF*

This model is hand held and will operate your appliances from most areas of your home – See **IMPORTANT NOTE** for exceptions.

It is powered by 3 AAA batteries. The controller uses radio signals to control your appliance.

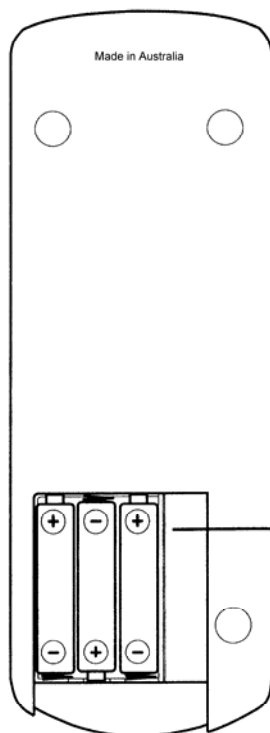
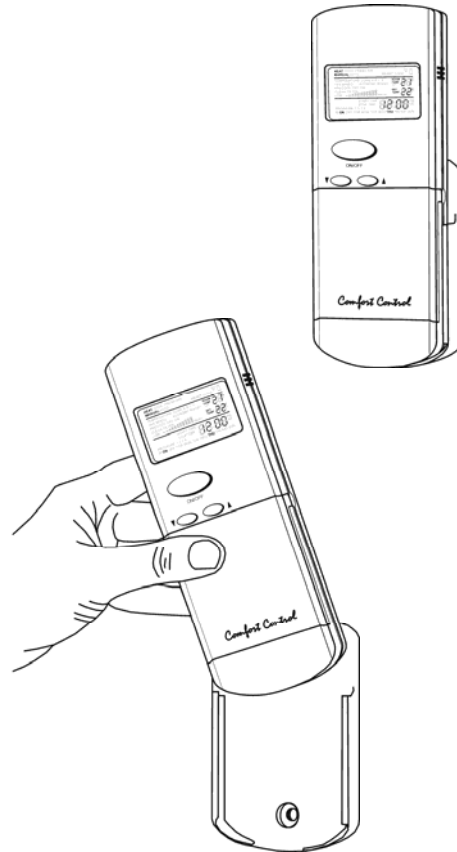

**Batteries (Hand Held RF only)**  
Three alkaline AAA size 1.5V batteries are required. Do not mix old and new batteries.

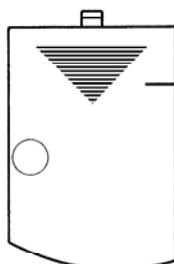

**Battery Door**  
Slide open door allow batteries To be easily installed without the Need for a tool

### **IMPORTANT NOTE**

To reduce the risk of possible RF interference, do not locate your RF control near any electrical equipment e.g. TV's computers, fridges, telecommunications and HI FI equipment or close to metal objects or window frames.

Other RF devices within your home can also cause interference such wireless door bells, gate or door openers, or perhaps baby monitors & intercoms. Such interference can impede the operation of your appliance.

Ensure the RF control unit is not exposed to excessive heat, humidity, moisture or dampness.



## Navigating the Controls

### The Comfort Controller

#### Features of the Controller

1. **Temperature sensor**

Measures room temperature for thermostatic operation.

2. **Display screen LCD (Liquid Crystal Display)**

Displays operational status of mode, time, day, room temperature, set temperature, temporary temperature, fan speed, filter cleaning, batteries and programming.

3. **Flip open door**

Covers the less frequently used secondary buttons.

4. **Soft touch buttons**

9 button layout includes large **ON/OFF** button

5. **Comfort Control cradle**

- Fixed to the wall to permanently mount the LV wall control.
- Fixed to the wall for easy access to the portable RF control.

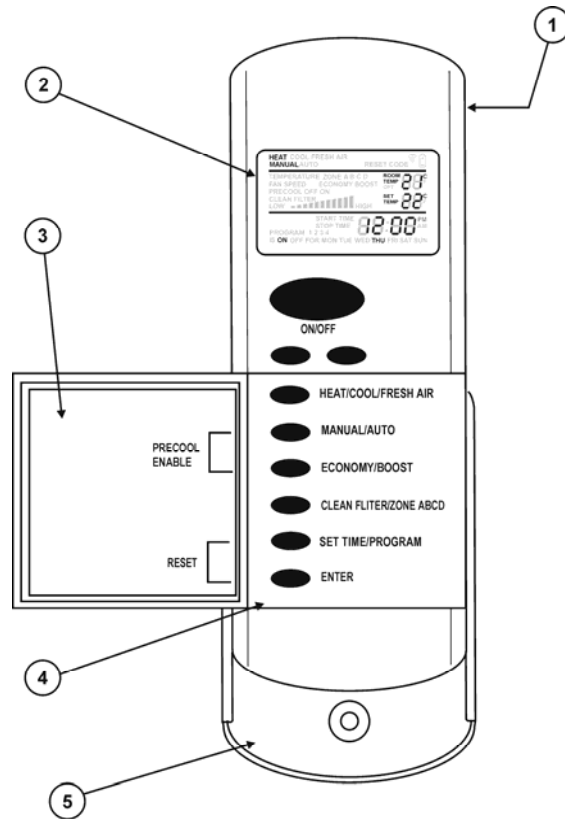

### THE LCD DISPLAY

The Controller display shows different information depending on the functions in use. The Controller usually shows only those items required for the appliances you have installed.

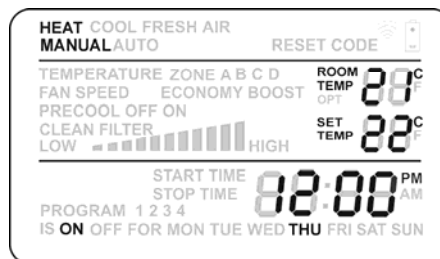

- Operation Mode Area
- Settings Display Area
- Programming Area





## Navigating the Controls

### USING THE 9 BUTTONS

The following explains the function of each of the buttons:

#### ON/OFF

- Turns your heating and / or cooling appliances ON and OFF. When you switch on in AUTO mode your preset programs stored in memory (heating only) will start to operate.
- During programming the **ON/OFF** button selects ON or OFF for the program period.
- Use to set Fresh Air Conditioner TIMER ON/OFF
- Use to turn ZONES on and off (if fitted)

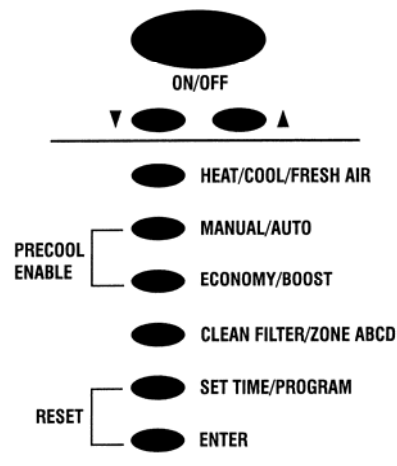

#### ▼ ▲ BUTTONS

- Press & hold ▼ ▲ (DOWN/UP) button to increase or decrease settings.
- Or press & release ▼ ▲ buttons to increase or decrease one setting at a time. Settings include day, time, temperature, fan speed and timer.
- The ▼ ▲ buttons are also used to select the different zones or programs available.

#### HEAT/COOL/FRESH AIR

- Press to select from the heating and or cooling choices (in most cases you will only be able to see the titles for the appliances that you have installed).
- **HEAT** Ducted Gas Central Heaters
- **COOL** Dual Cycle Add-on Refrigerated Air Conditioning
- **COOL FRESH AIR** Ducted Evaporative Air Conditioning
- **FRESH AIR** Fan only from your Fresh Air Conditioner
- **HEAT COOL** Automatic selection of either a Gas Central Heater or Dual Cycle Add-on Refrigerated Air Conditioning to maintain a desired temperature no title





## Navigating the Controls

shows' Fan only from your Heater (when no other appliance is installed)

### MANUAL/AUTO

- Press to select manual thermostat or programmed operation for heating and manual or thermostat for evaporative cooling.



### ECONOMY/BOOST

- Select economy, boost or normal operating modes.



### CLEAN FILTER/ZONE ABCD

- Press to select the different zones within the house (if available) or to activate the **CLEAN FILTER** facility when in **COOL FRESH AIR** mode.



### SET TIME/PROGRAM

- Press & release to select the programming options.
- To SET TIME, press and hold the button until **TIME** is displayed.



### ENTER

- Press and release to save settings when in SET TIME, PROGRAM mode and ZONE setting.
- Press and release to immediately send instructions.



### PRECOOL

- Press & release **MANUAL/AUTO** and **ECONOMY/BOOST** together to access PRECOOL settings. PRECOOL can be set with the Controller OFF.



### RESET

- Press & release **SET TIME/PROGRAM** and **ENTER** simultaneously to reset the unit if RESET is displayed.



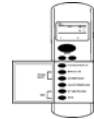

## Navigating the Controls

### FAULT CODE RECALL

- Press & release **SET TIME/PROGRAM** and **ENTER** simultaneously for 10 seconds to display the last fault code.
- Use the up arrow to display the last 4 fault codes.

### SETTING DAY AND TIME



After installing batteries for the first time or replacing old batteries (RF hand held model), or after a power cut (Low voltage hard wired model), the display will indicate OFF and the day and time when the batteries/power were last removed.

### SET TIME

Using SET TIME mode:

1. Press **ON/OFF** to switch the controller ON.
2. Press & hold the **SET TIME/PROGRAM** button for more than 2 seconds until TIME flashes. A DAY will also flash on the bottom row of the display.
3. Press **▲** to advance to next day or **▼** for previous days.
4. Press **ENTER** to select the day. The DAYS will stop flashing and the HOURS segments will flash.
5. Press **▲** to advance to next hour or **▼** for previous hours.
6. Press **ENTER** to select hour. HOUR will stop flashing and MINUTES will flash.
7. Press **▲** to advance to next minute or **▼** for previous minutes.
8. Press **ENTER** to select minutes.
9. Press **SET TIME/PROGRAM** to exit the time setting mode at any stage.



### 12/24 HOUR CLOCK

To change between the 12 hour and 24 hour clock modes

1. Press & hold the **SET TIME/PROGRAM** button for more than 2 seconds until TIME flashes.

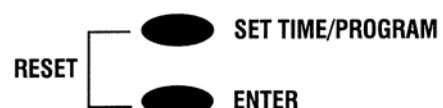

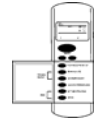

## Navigating the Controls

---

2. When TIME is flashing press the **SET TIME/PROGRAM** button again for approximately 3 seconds. The time will switch between the 12 and 24 hour clock. (AM or PM shows next to the clock in 12 hour clock mode.) Press **SET TIME/PROGRAM** to exit.

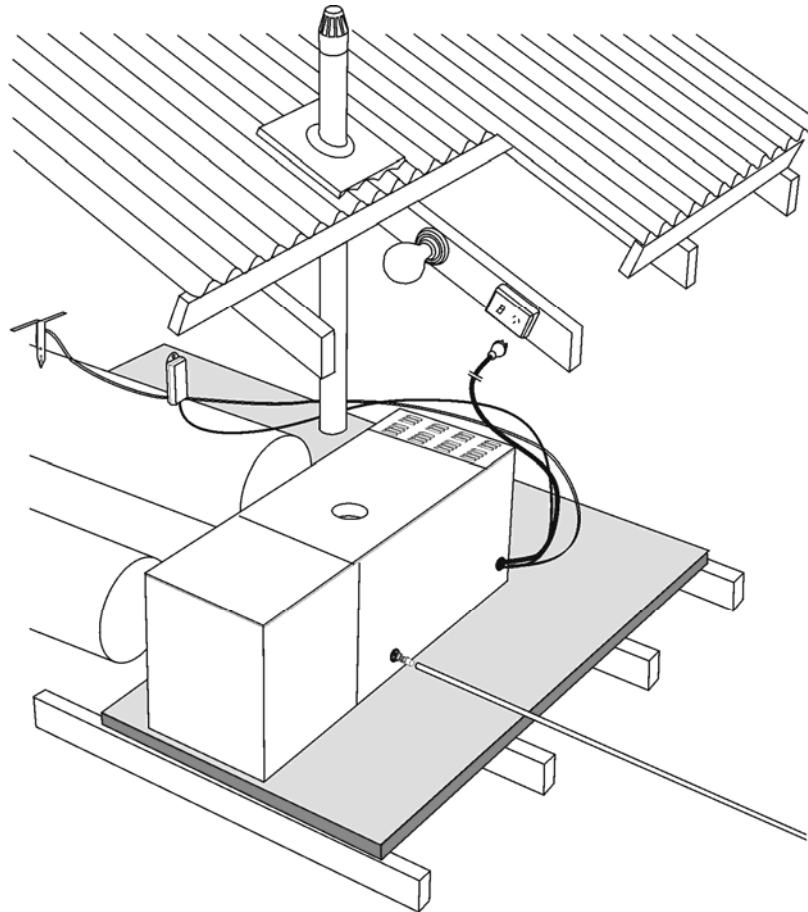
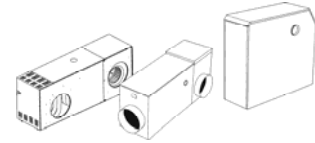

### *Owner's Operation and Maintenance Details*

**Please keep this important manual in a safe place. It is the owner's responsibility to ensure that regular maintenance is carried out on this Ducted Gas Central Heater. Failure to do so will void all guarantees beyond statutory and legal requirements.**

## Ducted Gas Heating

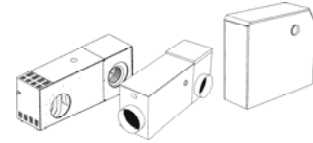

Congratulations on purchasing this Ducted Gas Central Heating system, an exciting new product manufactured by Climate Technologies.

Wholly designed and manufactured in Australia, this Ducted Gas Central Heater represents an exciting new development in warm air furnace design. It embodies the latest advances in gas heating technology.

Your heater is supported by Climate Technologies, Australia's most advanced manufacturer of a complete range of climate control products.

To ensure you fully enjoy the benefits of this Ducted Gas Central Heater, please read these instructions carefully and keep them handy for future reference.

Operated and maintained in accordance with this manual, this unit will provide you with years of warm and environmentally friendly operation. Please take the time to read this manual.

**NOTE: The manufacturer and its service providers reserve the right to refuse service unless safety and accessibility to the unit can be guaranteed in accordance with the installation instructions and Australian Standards. The cost of any extra equipment required to provide access to the unit for servicing is the responsibility of the owner.**

### GENERAL INFORMATION.

#### **IMPORTANT NOTICE.**

A licensed person is required to install Climate Technologies equipment. If the equipment is not installed in accordance with the installation instructions and the governing body regulations, Climate Technologies reserves the right to refuse service on non compliant installations.

Subject to state regulations and by laws a certificate of compliance must be issued for the electrical and plumbing connections certifying that the work complies with all the relevant standards.

Note: Only a licensed person will have insurance protecting their workmanship.

#### **DATA LOCATION.**

Your appliance model number, serial number and model description are located on the appliance data plate on the end of the heater or under the lid in the vicinity of the electronic controls. These details should also be in the warranty section of this booklet.

You will need this information, should your appliance require servicing, spare parts or just if you require additional information about this product.

#### **ASSEMBLY.**

There is no assembly required of this Ducted Gas Central Heater. Your Dealer or installer will carry out all assembly and commissioning upon installation.

## Ducted Gas Heating

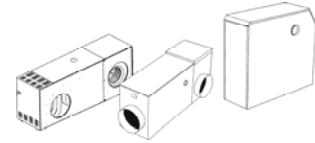

### SAFETY

#### **SAFETY & OWNER RESPONSIBILITY**

The manufacturer and its service providers reserve the right to refuse service unless safety and accessibility to the unit can be guaranteed in accordance with the installation instructions and Australian Standards. The cost of any extra equipment required to provide access to the unit for servicing is the responsibility of the owner.

#### **PRECAUTIONS.**

DO NOT PLACE ARTICLES ON OR AGAINST THIS APPLIANCE.

DO NOT USE OR STORE FLAMMABLE MATERIALS NEAR THIS APPLIANCE.

DO NOT SPRAY AEROSOLS IN THE VICINITY OF THIS APPLIANCE WHILE IT IS IN OPERATION.

DO NOT PLACE ARTICLES IN FRONT OF OR OVER THE RETURN AIR GRILLE.

#### **FEATURES.**

Your Ducted Gas Central Heater has all the safety devices to ensure safe operation. These devices conform to the standards set out by Standards Australian.

#### **POWER OR GAS INTERRUPTION.**

Should there be an interruption to the power supply during the heating operation the controls will automatically turn off the gas.

The heater will automatically resume operation once the power has been restored.

Should there be an interruption to the gas supply, the heater will endeavor to re-light 3 times and if unsuccessful will lock out. (This is part of the safety features). Should this occur the heater will need to be reset. To reset the heater press the **SET TIME/ ENTER** button for 5 seconds.

Please refer to your problem-solving chart to assist resolving other problems.

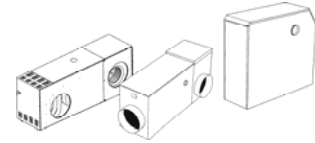

## Ducted Gas Heating

### USING YOUR COMFORT CONTROL

There is 2 ways to operate your Comfort Control. You can use **MANUAL** and select the operation modes or you can use the **AUTO** and program the operation modes to happen automatically.

#### MANUAL OPERATION

1. Turn the comfort control on, press and release the **ON/OFF** button. If there is only a central heater fitted the control will default to **Heat Cool**.

NOTE: Your Comfort Controller is designed to automatically detect the appliances you have installed, once coded. Controller options not required for your appliances will usually not be visible on your Comfort Control display. So don't worry if you don't see all the menu items listed in this book.

2. Press the **MANUAL/AUTO** button until **Manual** is displayed.
3. Press the **HEAT/COOL/FRESH AIR** button until **Heat** appears at the top of the display.
4. Press & hold the ▼ or ▲ buttons to decrease or increase SET TEMP or, press & release buttons to change the SET TEMP one degree at a time.
5. The Comfort Control measures the room temperature using a thermostat inside its case. When the room temperature is colder than the SET TEMP the Heater will come on after a 30 seconds ignition process.
6. The Comfort Control will run both the modulating and non modulating heaters until it measures temperature a little above your SET TEMP. The thermostat will then turn off the heater until the temperature falls a little below set temperature before restarting.
7. For modulating heaters, the operation of the heater is as follows:
  - If at start up the room temperature is more than 2.0° below the set temperature, the central heater will start up at high fan speed and high gas rate quickly bringing your house up to temperature.
  - As the room temperature gets closer to the set temperature the central heater will reduce the room air fan and the gas rate to the burner.
  - When the thermostat reaches the set temperature the central heater will be on low fan and the gas will modulate to low fire.

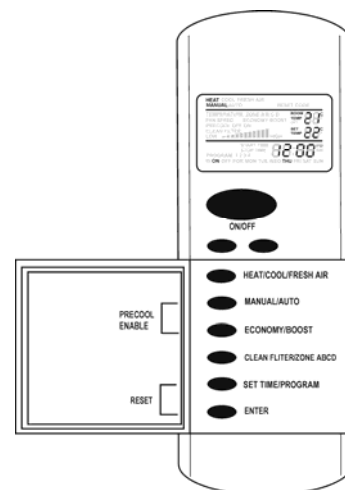



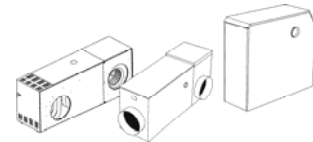

## Ducted Gas Heating

- When the temperature has gone past the set temperature by approximately a  $\frac{1}{2}^{\circ}$  the central heater will shut down.
  - When the temperature has dropped approximately  $1^{\circ}$  below set temperature the unit will restart.
  - As your activities vary, you may find you need different temperature settings, e.g. a temperature comfortable for sitting is usually too warm compared to when you're moving about.
  - For economical operation, set a low SET TEMP during the day when you are active, or use ECONOMY. Switch the Comfort Control OFF when asleep and ON again when awake. These cost saving functions can be programmed to operate automatically (see Programmed Control).
8. Press the **ON/OFF** button to switch the heater OFF. OFF will appear on the display.
  9. The Comfort Control remembers your SET TEMP setting and uses it next time you turn it ON.

### ECONOMY & BOOST FOR HEATING

ECONOMY operates the heater at the lowest fan speed and a lowest possible gas rate continuously.

Note: - Continual use of economy may not heat the environment effectively.

BOOST operates at the highest fan speed and a highest possible gas rate continuously.

1. To select ECONOMY or BOOST switch the Controller ON and select HEAT and MANUAL.
2. Now press **ECONOMY/BOOST**. The display will first show ECONOMY. Press again and BOOST is shown. Save your selection by pressing **ENTER**.
3. Set Temperature to the desired level.



### SUMMER FAN

With Gas Ducted Central Heating the control default is to run a Dual Cycle Add-on Cooling system if installed. If there is no Add-on Cooling you can use the fan only to circulate the air. To operate:

1. Press **ON/OFF** to switch the controller ON.
2. Press the **HEAT/COOL/FRESH AIR** button until **COOL** appears by it's self in the mode selection line of the LCD.  
The room air fan will now run.

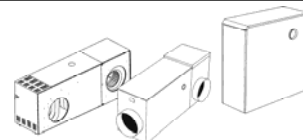

## Ducted Gas Heating

### ZONES - SELECTING ABCD OPTIONS

Selecting ZONE ABCD only applies if your home is fitted with optional motorised ductwork dampers (please consult your installer) that allow opening or closing of each section of ducting.

Many homes have no motorised ductwork dampers fitted, however the control will still display the 'A' zone. Where zone motors are fitted the installer can set your controller to show only the zones available for use.

In homes with more than one zone, at least one zone must be open at all times. The default zone is A if no other is selected.

The Controller will not allow you to turn all off. If you press and release ENTER with all zones set to off the Controller will recall your last correct zone setting.

To set the open or closed status of a ZONE:

1. Press and release the **CLEAN FILTER/ZONE ABCD** button. ZONE A (or the current open zone) will flash.
2. Press ▼ or ▲ to select the zone you wish to control.
3. Press the **ON/OFF** button to set a zone as open (ON) or closed (OFF). Repeat to open or close more zones. If the letter is already displayed on the LCD screen the zone is open / on.
4. Press and release **ENTER** to save your selections. Now the Heater operates only in your selected zone.

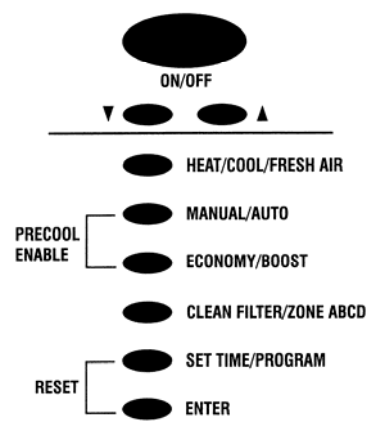

 **CLEAN FILTER/ZONE ABCD**

### OPTIONAL SUMMER SHUTDOWN

1. Switch the Comfort Control **OFF**
2. Switch the power point OFF and turn the gas tap OFF. They are usually located close to the Heater.

### FIRST STARTUP OR RESTART AFTER SHUTDOWN

1. Switch the Comfort Control ON, (Check the batteries are still good – RF remote model only. It's a good idea to replace them at the beginning of the season.)
2. Switch on the power point to the heater. Turn on the gas tap on the gas supply line into the heater.
3. Select **HEAT** and **MANUAL**. Press & hold ▼ or ▲ button to decrease or increase the **SET TEMP**. Press **ENTER**.

**Ducted Gas Heating**

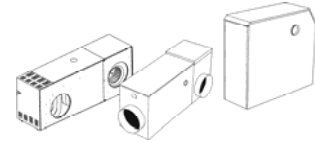

**AUTO MODE**

Auto mode is where the Comfort control operates your unit to a specific set of program settings. The default sequence is as per the chart. To set your program, see next section *Programming Your Comfort Control*.

To operate your unit in AUTO mode, press the MANUAL/AUTO for the screen to display the word AUTO. The unit will now turn on and off at specific times and will change operational functions as programmed.

**Factory Settings**

MON,TUE,WED,THU,FRI,SAT,SUN			
PROGRAM	START TIME	SET TEMP	ACTION
1	6:00AM	20°C	HEAT ON
2	9:00AM		OFF
3	5:00PM	20°C	HEAT ON
4	10:00PM		OFF

**PROGRAMMING YOUR COMFORT CONTROL**

Programming your Comfort Control will provide energy and time savings. Your heating and or cooling system will only operate when you need it, and at your chosen comfort levels.

Determine your most comfortable settings, program them and let your Comfort Control do the rest automatically.

**Programming Sequence**

Heater / Dual Cycle Add-on Refrigerated Air Conditioning

If you've never programmed your Comfort Controller before (or it's been a while) remember it's easiest to program the whole week to the same settings (by selecting the whole week MON TUE WED THU FRI SAT SUN day choice) and then program variations for particular days or the weekend as you become more familiar with programming.

If the Controller exits program mode it may be because you've paused longer than about 15 seconds to make your next choice. All the settings you've made up to then will be saved. Just switch back to program mode, scroll through your settings using the ENTER key and carry on from where you left off.

The following is the programming sequence once the control is turned on:-

1. *To Start Program:* Press the **SET TIME/PROGRAM** button. PROGRAM 1 and the current day will flash.
2. *Selecting the Days / Day Group:* Press the ▲ ▼ arrows to select the day or day group to be modified. Options are: Single Day, MON TUE WED THU FRI or SAT SUN or MON TUE WED THU FRI SAT SUN. Press **ENTER** to complete the selection
3. *Turning the unit On or Off:* Press the **ON/OFF** button to turn the unit ON or OFF. At this point the control display will be ON or OFF and the timer hour number will be flashing.
4. *Selecting the Product: if unit ON:* If your heater has been fitted with an add-on refrigerated air conditioner your can now select between heating and cooling. Press the **HEAT/COOL/FRESH AIR** button to select the product require, else proceed to the next step.

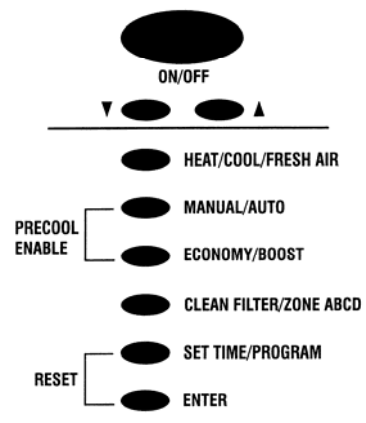

**SET TIME/PROGRAM**

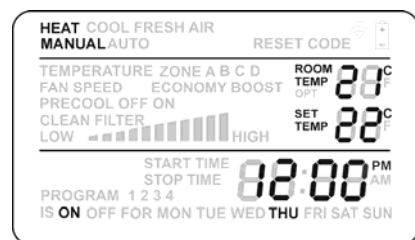

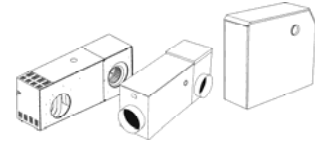

## Ducted Gas Heating

5. *Setting the time to start the program:* Using the ▲ ▼ arrows set the HOUR required and press **ENTER**. The MINUTES number will flash. Using the ▲ ▼ arrows set the minutes number required. The time will now be set. Press **ENTER** to proceed.
6. *Setting the operation parameters:* Before accepting or adjusting the temperature you can also set:-
  - ZONE Requirements - If ZONE motors fitted select the zones to be open or closed.
    - Press and release the **CLEAN FILTER/ZONE ABCD** button. ZONE A (or the current open zone) will flash
    - Press ▼ or ▲ to go to the next zone. Press the **ON/OFF** button to set a zone as open (ON) or closed (OFF). Repeat to open or close more zones.
    - Press and release **ENTER** to save your selections. Now the Heater operates only in your selected zone.
  - ECONOMY / BOOST - press **ECONOMY/BOOST**. The display will first show ECONOMY. Press again and BOOST is shown.
7. *Setting the Temperature:* use the ▲ ▼ arrows set the required temperature. Press **ENTER**. The next PROGRAM period will flash.
8. If next program is required to be OFF use function steps 3 & 5. The next PROGRAM will now be flashing.
9. If next program is required to be ON. Use steps 3, 4, 5, 6 & 7. After steps 3, 4, 5, 6 & 7 are completed the next PROGRAM period will be flashing.

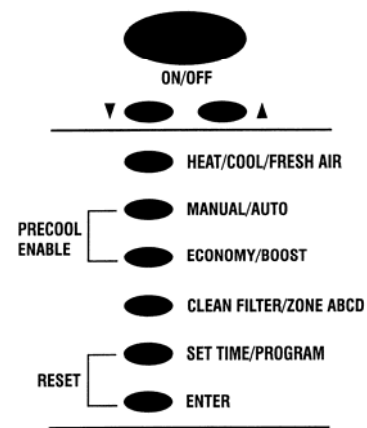

If you want to make corrections to what you've entered, press SET TIME/PROGRAM twice and you'll start the programming sequence again. Scroll through the program selections by pressing the ENTER key and change any items as you come to them.

If at any stage in programming mode you want to revert to the factory default settings, remove the batteries (RF model only) or turn the power off to the unit for hardwired controls and the settings will be as they were before you started.

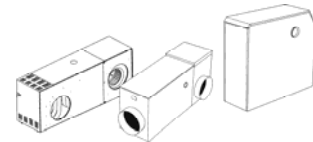

## **HEATER MAINTENANCE**

### *CLEANING.*

**Warning:** Before commencing any maintenance work on your unit, isolate the power at the supply (Fuse Box).

**Note:** It is essential that your central heater be maintained in accordance with this manual. Failure to do so will affect the life of the product and reduce the level of efficiency.

### *ELECTRICAL*

No general maintenance is required to the electrical system.

A Qualified Electrician should only carry out electrical connections and maintenance.

### *RETURN AIR GRILLE FILTER.*

If your heating system has a filter in the return air grille, it is extremely important it is cleaned every 3 – 4 weeks during the operating period to ensure correct operation of the heating unit. Failure to do so may cause your heater to stop because of over temperature and cause an unnecessary service call not covered by warranty.

### *FLUE.*

The flue and cowl assembly should be clean and free of obstructions.

## **SCHEDULED MAINTENANCE.**

Your Ducted Gas Central Heater should be serviced annually to ensure trouble free operation.

1. To ensure that your heater continues to operate at peak efficiency it is recommended that it be periodically serviced by a qualified service technician
2. Fan blades, motors should ignition systems and burners should be checked every year. Heater cabinet and immediate surroundings should be kept clean.
3. Replace the batteries in the Radio Frequency Comfort Controller (where fitted) at the start of each heating season with new AAA alkaline batteries.

### *OTHER ITEMS.*

There are other items your Climate Technologies service technician will attend to on scheduled maintenance.

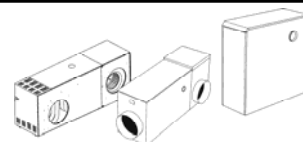
**Ducted Gas Heating****PROBLEM SOLVING.***CENTRAL HEATER WILL NOT OPERATE!*

	Question	Y/N	Solution
1.	Has the unit been run since installation?	Yes	Refer to question 4
		No	Check the unit is turned on at the power point and the gas cock is turned on. Call the installer to commission the unit.
2.	Is the unit installed in a new home?	Yes	Refer to question 3
		No	Refer to question 4
3.	Has the installer run the unit?	Yes	Refer to question 4
		No	Check the unit is turned on at the power point and the gas cock is turned on. Call the installer to commission the unit.
4.	Is the set temperature greater than the room temperature?	Yes	Press the reset buttons or turn the unit off then on to reset unit. If the unit still does not start call for service. (refer to solution 6 for reset instructions)
		No	Increase the set temperature so the thermostat calls for heat.
5.	Is the thermostat in program mode?	Yes	The heater may be programmed to be OFF. To operate the heater manually press the Manual / Auto button until the MANUAL is displayed. Adjust the room thermostat greater than set temperature.
		No	Adjust the room thermostat greater than set temperature.
6.	Has there been a known power surge?	Yes	Reset the unit. This can be done by: <ol style="list-style-type: none"> <li>1. Turn the power OFF then ON at the power point</li> <li>2. Turn the control to OFF</li> <li>3. Pressing the reset button on the circuit control board</li> </ol>
		No	Unit should operate normally. If not a service call will be required.

THIS TROUBLE SHOOTING GUIDE IS A REFERENCE ONLY.  
FOR SERVICE OR WARRANTY REQUIREMENTS PLEASE REFER TO  
THE WARRANTY SECTION OF THIS BOOK

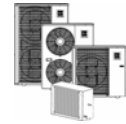

## Dual Cycle Addon Refrigerated Air Conditioning

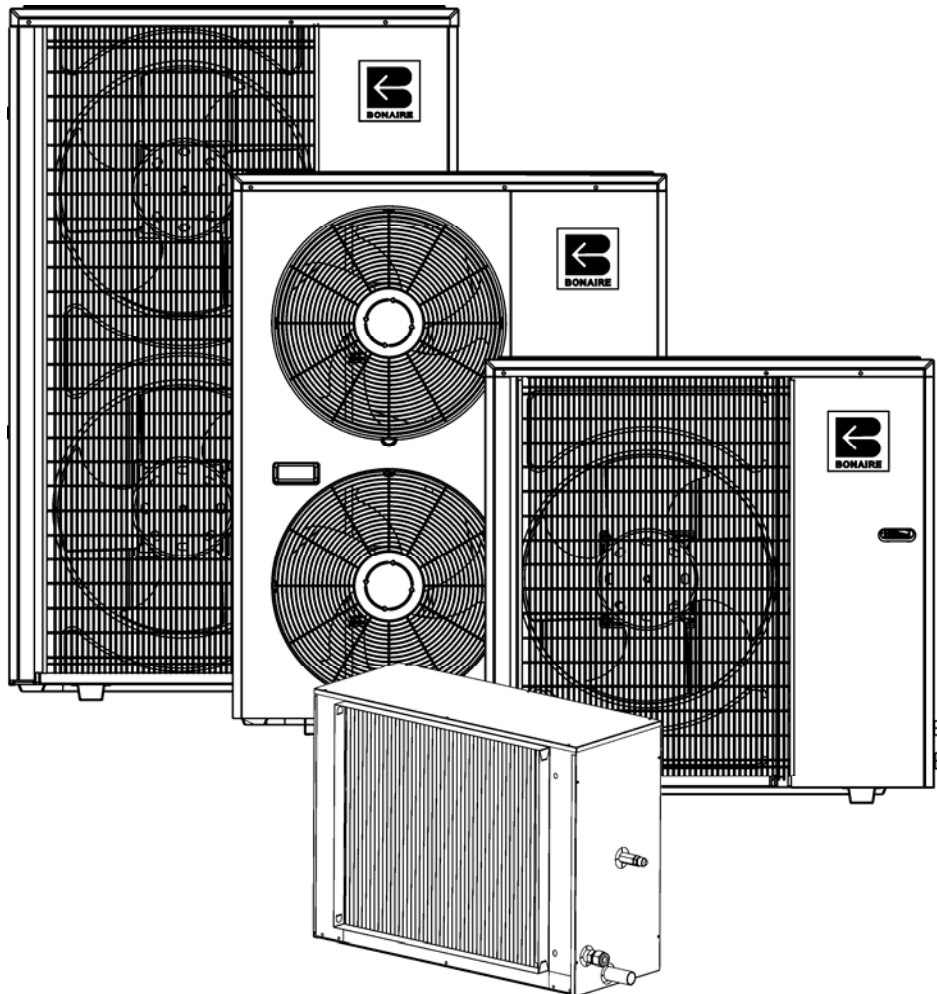

Please keep this important manual in a safe place. It is the owner's responsibility to ensure that regular maintenance is carried out on this Dual Cycle Ducted Gas Central Heater / Add-on Refrigerated Air Conditioner. Failure to do so will void all guarantees beyond statutory and legal requirements.

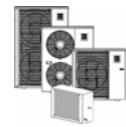

---

## Dual Cycle Addon Refrigerated Air Conditioning

---

### **GENERAL INFORMATION.**

#### **IMPORTANT NOTICE.**

If an appropriately qualified and licensed person is not used to install the equipment or if it's not installed according to the guidelines, then Climate Technologies will not accept responsibility for any problems, which occur as a result.

#### **DATA LOCATION.**

Your appliance model number, serial number and model description are located on the appliance data plate on the access panel. These details should also be in the warranty section of this booklet.

You will need this information, should your appliance require servicing, spare parts or just if you require additional information about this product.

#### **ASSEMBLY.**

There is no assembly required of this Add-on Refrigerated Air Conditioner. Your Dealer or installer will carry out all assembly and commissioning upon installation

### **SAFETY**

#### **SAFETY & OWNER RESPONSIBILITY**

The manufacturer and its service providers reserve the right to refuse service unless safety and accessibility to the unit can be guaranteed. The cost of any extra equipment required to provide access to the unit for servicing is the responsibility of the owner.

#### **PRECAUTIONS.**

DO NOT PLACE ARTICLES ON OR AGAINST THE CONDENSER.

DO NOT PLACE ARTICLES IN FRONT OF THE CONDENSER.

ENSURE THE CLEARANCES BETWEEN THE UNIT AND WALL ARE KEPT CLEAR.

DO NOT PLACE ARTICLES IN FRONT OF OR OVER THE RETURN AIR GRILLE.

#### **FEATURES.**

Your Ducted Gas Central Heater and Add-on Refrigerated air conditioner has all the safety devices to ensure safe operation. These devices conform to the standards set out by Standards Australia.

#### **POWER INTERRUPTION.**

Should there be an interruption to the power supply during the cooling operation the controls will automatically shut down.

Your gas ducted heater and or add-on cooler will automatically resume operation once the power has been restored.



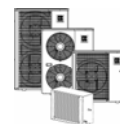

## Dual Cycle Addon Refrigerated Air Conditioning

### COMFORT CONTROL

Using your Comfort Control for manual operation of your Add-on Refrigerated Air Conditioner is the same as your gas central heater where you want direct control, without timers or programming.

**Note: When the Add-on cooler is selected, the default setup for the room air fan is to thermostatically cycle with the condenser unit until the control is turned OFF or the control is programmed OFF.**

### MANUAL OPERATION

1. To turn the comfort control ON, press and release the **ON/OFF** button. The controls will display HEAT and or COOL.
2. Press the **MANUAL/AUTO** button until **Manual** is displayed.
3. Press the **HEAT/COOL/FRESH AIR** button until COOL appears at the top of the display. The heater fan will start immediately.
4. Press & hold the ▼ or ▲ buttons to decrease or increase **Set Temp** or, press & release buttons to change the **Set Temp** one degree at a time.
5. The Comfort Control measures the room temperature using a thermostat inside its case. When the room temperature is warmer than the **Set Temp** the add-on cooler condenser will cycle on.
6. The Comfort Control will run the Add-on Cooler until it measures temperature a little below your **Set Temp** and turn off the add-on cooler condenser.
7. The operation of the Add-on cooler is as follows:
  - The Add-on cooler will start almost immediately when first turned ON. Once the unit has turned OFF when in operation there is a 5 - 8 minute delay before it will resume again and a minimum of 5 minutes operating timer before it can turn off again.
  - When the room temperature has gone below the set temperature by approximately a  $\frac{1}{2}^{\circ}$  the add-on cooler condenser will cycle off. The room air fan will also cycle off.
  - When the temperature has increased to approximately  $1^{\circ}$  above set temperature the add-on cooler condenser and room air fan will restart.
  - As your activities vary, you may find you need different temperature settings, e.g. a temperature comfortable for sitting is usually too cold compared to when you're moving about.
  - For economical operation, set a low SET TEMP during the day when you are active. Switch the Comfort Control OFF when asleep and ON again when awake. These cost saving functions can be programmed to operate automatically (see Programmed Control).

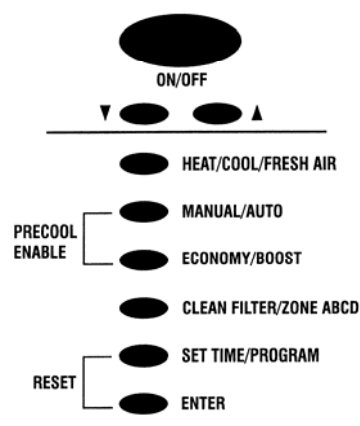

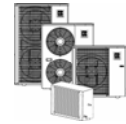

## Dual Cycle Addon Refrigerated Air Conditioning

8. Press the **ON/OFF** button to switch the cooler OFF. OFF will appear on the display.
9. The Comfort Control remembers your SET TEMP setting and uses it next time you turn it ON.

### ZONES - SELECTING ABCD OPTIONS

Selecting ZONE ABCD only applies if your home is fitted with optional motorised ductwork dampers (please consult your installer) that allow opening or closing of each section of ducting.

Many homes have no motorised ductwork dampers fitted, however the control will still display the 'A' zone. Where zone motors are fitted the installer can set your controller to show only the zones available for use.

In homes with more than one zone, at least one zone must be open at all times. The default zone is A if no other is selected.

The Controller will not allow you to turn all off. If you press and release ENTER with all zones set to off the Controller will recall your last correct zone setting.

To set the open or closed status of a ZONE:

1. Press and release the **CLEAN FILTER/ZONE ABCD** button. ZONE A (or the current open zone) will flash
2. Press ▼ or ▲ to go to your selected zone. Press the **ON/OFF** button to set a zone as open (ON) or closed (OFF). Repeat to open or close more zones.
3. Press and release **ENTER** to save your selections. Now the Add-on air conditioner operates only in your selected zone.

 **CLEAN FILTER/ZONE ABCD**

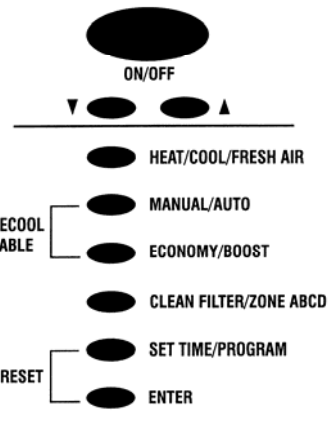

### FAN OPERATION

The default setting is for the fan to run at the same time as the condenser unit, therefore thermostatically cycling on and off with the cooling.

Should you require the fan to run continuously with the condenser only cycling on and off, refer to the setup section of this document.

### PROGRAMMING YOUR COMFORT CONTROL

Programming your Comfort Control will provide energy and time savings. Your heating/cooling system will only operate when you need it, and at your chosen comfort levels.

Determine your most comfortable settings, program them and let your Comfort Control do the rest automatically.

### USING THE PROGRAMMING SEQUENCE

Refer to Ducted Gas Central Heating Section for *Auto Mode* and *Programming Your Comfort Control*.

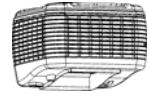

## Ducted Evaporative Air Conditioning

---

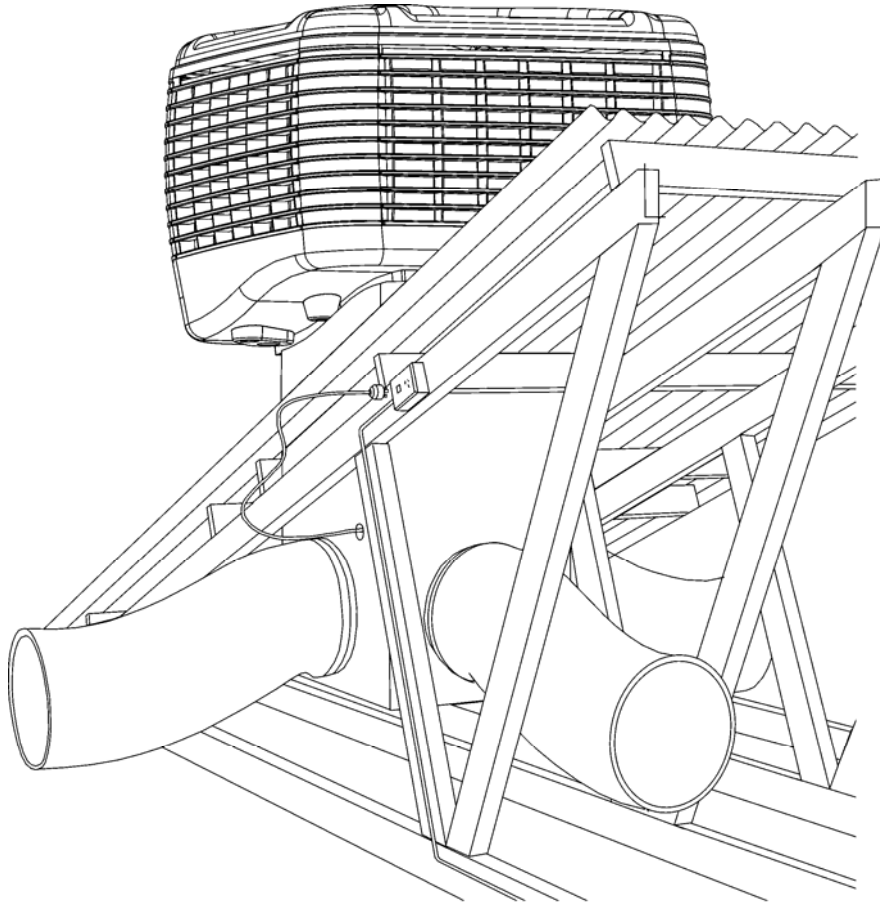

### Owners Operating and Maintenance

**Please keep this important manual in a safe place. It is the owner's responsibility to ensure that regular maintenance is carried out on this Ducted Evaporative Air Conditioner. Failure to do so will void all guarantees beyond statutory and legal requirements.**

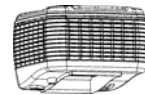

## Ducted Evaporative Air Conditioning

### INTRODUCTION

Your ducted evaporative air conditioner is engineered to meet the rigours of our harsh Australian environment. Operated and maintained in accordance with this manual, it will provide you with years of quiet, cool and environmentally friendly operation. Please take the time to read this manual.

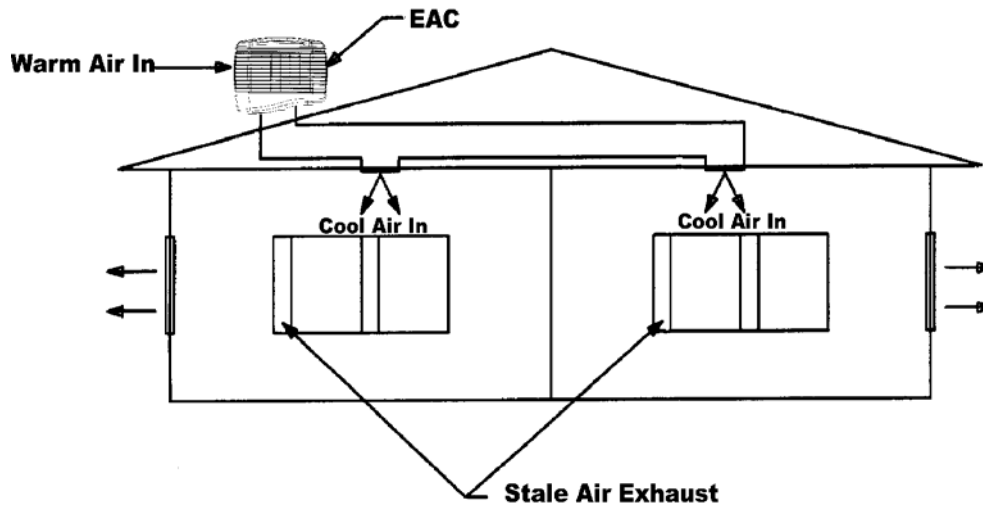

The principal of your unit is to introduce fresh air, which is washed through the filter pads to provided cool fresh air. The air is exhausted taking with it any heat loading on the home.

### UNIT OPERATION

#### EXHAUST

It is essential for successful operation of evaporative air-conditioning that there are sufficient exhaust openings in the area to be ventilated. Open doors and windows will usually provide this.

The minimum exhaust opening should be as per the table guide set out below. It is recommended that ceiling vents or exhaust fans be used where there is any doubt about there being sufficient exhaust area available. Ceiling exhaust fans or ceiling vents should have a capacity equivalent to that of the air conditioner.

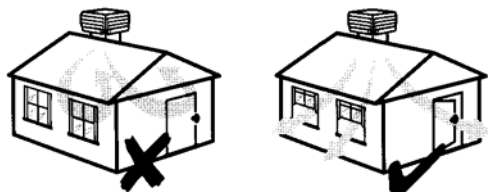

Vent Area for Doors and Windows

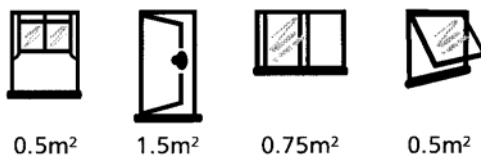

MODEL	MINIMUM EXHAUST AREA
Small	0.85 m <sup>2</sup>
Medium	1.19 m <sup>2</sup> to 1.48 m <sup>2</sup>
Large	2.02 m <sup>2</sup>

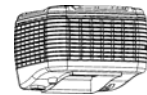

## Ducted Evaporative Air Conditioning

### WATER MANAGEMENT

All evaporative air conditioners need some water to go to waste to prevent build-up of mineral deposits in the system. Your unit has been supplied with a dump valve as well as a bleed control to provide maximum options for best water management.

The correct setting of the dump valve and bleed will ultimately govern the life of the unit. Should there be evidence of a build up of mineral deposits in the unit, review the dump and or bleed-off values.

Failure to manage the correct levels of dissolved solids in the unit will void warranty. Refer to your local dealer for best settings.

#### Dump Valve

The dump valve provided with your unit is able to be operated with various timed dumping options (0, 1, 2, 4, 8, 12, 24 hours).

Dumping cycles will have to be activated (refer to the setup section of this document) and set in accordance with the water quality in your area. In areas of good water quality, the correct dumping cycle only may suffice and the bleed-off function in the Dialflo may not be required. Increased water hardness may require a bleed rate as well as a dump cycle and increased maintenance.

Drainage from the dump valve must be plumbed away in accordance with local and state plumbing requirements. However this water could also be stored in a non drinking water tank for other use.

#### Set the Water Distribution Flow Rate

To set the water distribution rate locate the DIALFLO externally on one of the unit corner posts. Rotate the filter knob (the outer knob) anti-clockwise for more water and clockwise for less water. Do this before setting a bleed rate.

#### Set the BLEED-OFF Rate.

Use the DIALFLO to rotate the BLEED knob (the inner knob) clockwise for more water flow and anti clockwise for less.

Note: Hold the distribution knob (Filters) while setting the bleed rate as the distribution flow rate may go out of adjustment.

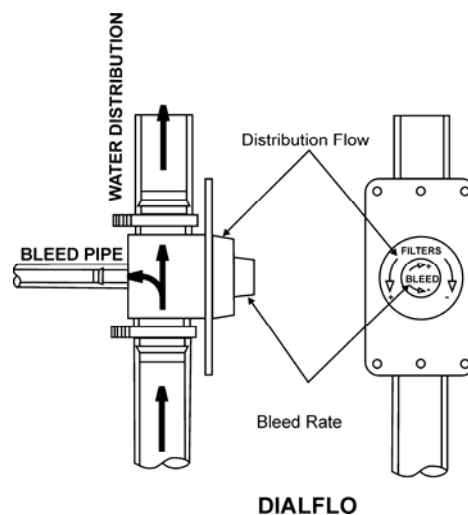
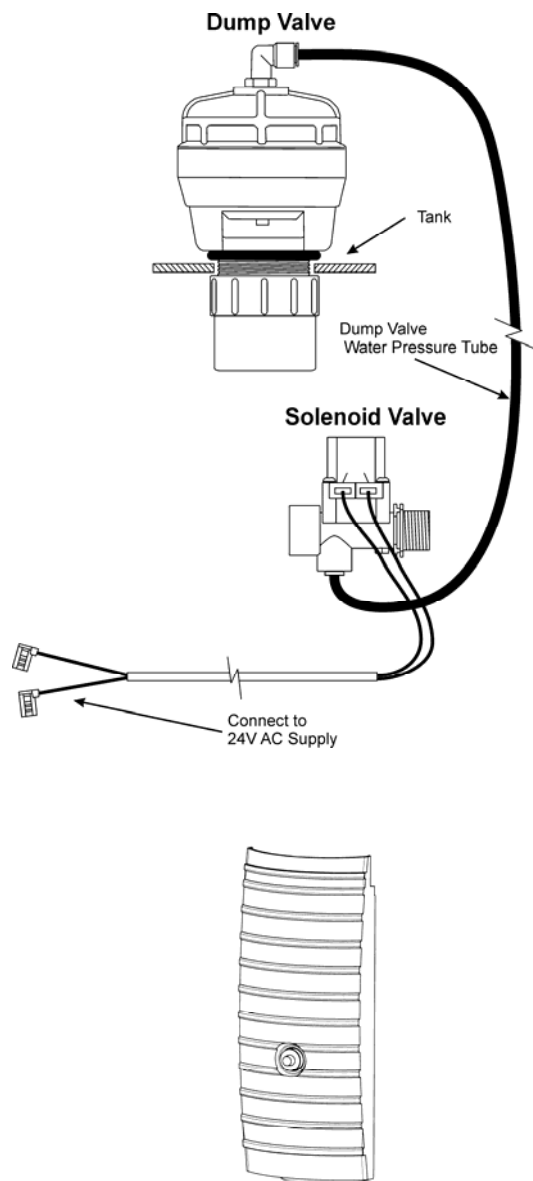

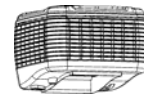

## Ducted Evaporative Air Conditioning

### COMFORT CONTROL – QUICK REFERENCE

Your Comfort Controller can be used to operate your ducted evaporative air conditioner 3 ways being Manual, Auto and Timer modes:

1. **Manual Mode** – to operate:
  - 1.1. Turn ON the unit.
  - 1.2. Set the fan speed to the desired level.
  - 1.3. Set the pump ON or OFF.
  - 1.4. Set the mode of operation e.g. ECONOMY, BOOST OR NORMAL.
  - 1.5. Turn OFF the unit when you no longer wish to operate it.
  
2. **Auto Mode (Thermostat)** – to operate:
  - 2.1. Turn ON the unit.
  - 2.2. Press the MANUAL/AUTO button to select AUTO.
  - 2.3. Set the temperature scale to the desired level.
  - 2.4. The unit will now operate until the comfort level has been achieved, adjusting the fan speed as required. When the temperature in the space increases, the unit will resume operation.
  - 2.5. Turn the control OFF when you no longer wish to operate the unit.
  
3. **Timer Mode** – using the timer STOP or START mode.
  - 3.1. Select the evaporative cooler settings to operate e.g. FRESH AIR, COOL FRESH AIR, FAN SPEED or AUTO.
  - 3.2. START or STOP at a specified time.
  - 3.3. Use the ▼ or ▲ buttons to set the time for ON or OFF.
  - 3.4. To cancel the settings, press the control ON/OFF button.

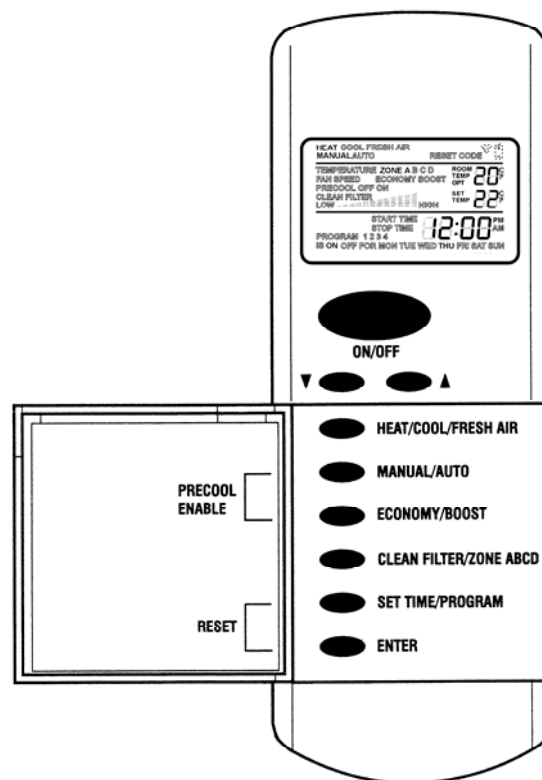

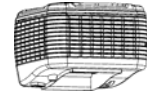

## Ducted Evaporative Air Conditioning

### USING YOUR COMFORT CONTROL

Your Comfort Controller can be used to operate your ducted evaporative air conditioner 3 ways being Manual, Auto and Timer modes.

#### MANUAL MODE

Using the Comfort Control to manual operation the fan and pump without using timers or programming.

1. Turn the comfort control ON, press and release the **ON/OFF** button. If there is only an evaporative ducted air conditioner fitted the control will default to COOL FRESH AIR.

NOTE: Your Comfort Controller is designed to automatically detect the appliances you have installed. Controller options not required for your appliances will usually not be visible on your Comfort Control display. So don't worry if you don't see all the menu items listed in this book.

2. Press the **MANUAL/AUTO** button until MANUAL is displayed.
3. Press the **HEAT/COOL/FRESH AIR** button until FRESH AIR appears at the top of the screen for fan only  
or  
**COOL FRESH AIR** appears at the top of the screen for pump and fan operation.
4. Press & hold the ▼ or ▲ buttons to decrease or increase FAN SPEED on step at a time.
5. To turn the unit OFF press the ON/OFF button.



#### AUTO MODE (THERMOSTAT)

Using your Comfort Control for thermostatic operation of the fan speed and the pump operation.

1. Turn the comfort control ON by pressing and releasing the **ON/OFF** button. If there is only an evaporative ducted air conditioner fitted the control will default to **COOL FRESH AIR**.
2. Press the **MANUAL/AUTO** button until **AUTO** is displayed.
3. Press & hold the ▼ or ▲ buttons to decrease or increase the temperature. Less bars = cooler, more bars = warmer.
  - Set the temperature scale to a relative point where you feel comfortable.
  - The fan will now be adjusting itself up and down according to need automatically.
  - As the room temperature nears the selected relative temperature the water pump will turn off with the fan still running. The fan will only stop if the room temperature is more than 1 degree below the required relative temperature.
4. To turn the unit OFF, press the ON/OFF button.

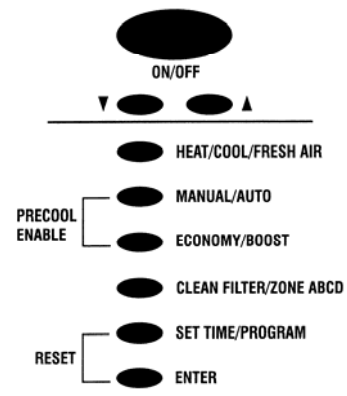

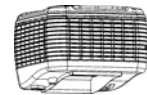

## Ducted Evaporative Air Conditioning

### BOOST

BOOST operates the Fresh Air Conditioner at its highest fan speed. This function can be used to give a quick over ride to your normal operating settings.

- BOOST is used only in MANUAL mode.
- Press the ECONOMY/BOOST button. All the bars are displayed for full fan speed.

Press the ECONOMY/BOOST button again and the unit will resume its previous manual settings.



### TIMER MODE

Using your Comfort Control for timer controlled operation of your ducted evaporative air conditioner when you want the unit to turn ON or OFF at a specific time at predetermined settings. The timer modes are only able to be set for any one day at a time.

#### 1. START TIME – Before setting the start time

- Press MANUAL/AUTO button for MANUAL or THERMOSTAT mode.
- For MANUAL mode select COOL FRESH AIR or FRESH AIR only and set the FAN SPEED.
- For THERMOSTAT mode adjust the thermostat setting as required
- Press the SET TIME/PROGRAM button until START TIME flashes on the screen.
- Set the timer by using the ▼ or ▲ buttons. Hold the button down until the correct hours and minutes appear.
- The unit will now start at the time set using the last mode setting used on the controls.



#### 2. STOP TIME –

- Press the SET TIME/PROGRAM button until STOP TIME flashes on the screen.
- Set the timer by using the ▼ or ▲ buttons. Hold the button down until the correct hours and minutes appear.
- The unit will now start at the time set using the last mode setting used on the controls.

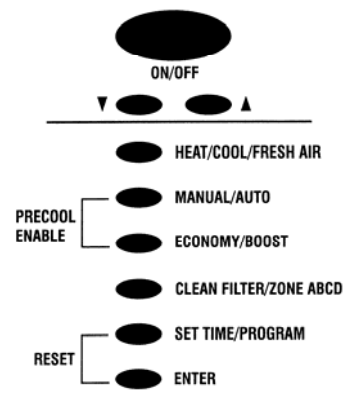



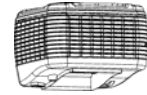

## Ducted Evaporative Air Conditioning

### PRECOOL ON/OFF

The PRECOOL option pre-wets the Fresh Air Conditioner filter pads before any air is circulated through your home. PRECOOL will flash on the display.

If PRECOOL is enabled, the unit will run the pump with no fan for 3 minutes every time the air conditioner is turned ON in COOL FRESH AIR mode.



### Setting PRECOOL

- The Controller can be ON or OFF to set PRECOOL.
- Press the MANUAL/AUTO and ECONOMY/BOOST buttons at the same time.
- PRECOOL ON or OFF will flash. Use the ▼ or ▲ buttons to select PRECOOL ON or OFF.
- The words will flash for 15 seconds and then the signal will be sent to your Conditioner. Pressing ENTER will send the signal immediately.
- The PRECOOL option can be disabled at any time by pressing MANUAL/AUTO and ECONOMY/BOOST together then selecting PRECOOL OFF.

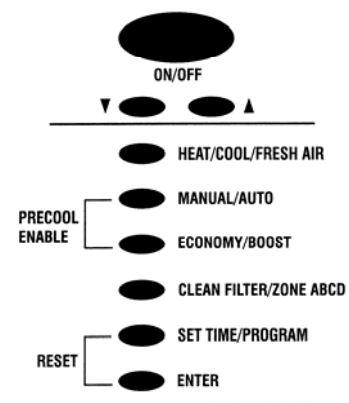

### FILTER CLEANING

CLEAN FILTER function operates the pump only for 30 minutes allowing a nominal wash down of the filter pads. This can help extend the life of the pads. To activate CLEAN FILTER

1. Press CLEAN FILTER. The unit will perform a self cleaning procedure which will last for around half an hour. CLEAN FILTER will flash on the display during this operation.
2. You can exit the CLEAN FILTER procedure at any time by selecting any of the Fresh Air Conditioning options.

NOTE: Normally during the first 10 days of operation a slight odor will be present from the CELDEK filter pads. This 'new smell' is quite normal, and will quickly disappear as your unit is operated.



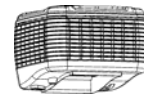

---

## Ducted Evaporative Air Conditioning

---

### Ducted Evaporative Air Conditioner Maintenance

#### GENERAL.

All Ducted Evaporative Air Conditioners benefit from some general maintenance to ensure continued cooling efficiency and a long life. Maintenance is carried out at the beginning and end of summer to start up and close down your unit.

We recommend that all maintenance work be undertaken by our fully trained and accredited Service Technicians or an authorised Climate Technologies Service Provider.

The frequency of general maintenance will depend on local operating conditions such as water quality, air borne dust and pollen.

It is essential that your evaporative air conditioner is maintained in accordance with this manual. Failure to do so will affect the life of the product, reduce the level of efficiency and may void warranty.

For service Australia wide refer to the details on the service section of this manual.

**NOTE: The manufacturer and its agents reserve the right to refuse service unless safety and accessibility to the unit can be guaranteed. The cost of any extra equipment required to provide access to the unit for servicing is the responsibility of the owner.**

**SAFETY: Prior to commencing any maintenance isolate the unit at the power source. Ensure the roof is safe to access, your ladder is securely positioned and use suitable safety equipment.**

#### FILTER PADS

Visually check CELDEK pads for damage or blockage. Hose down pads from both sides to remove any build up of salts, dust and pollen. In dusty areas more regular cleaning is recommended. Check the water distributor, making sure it is clear and free from blockage. Failure to do so may lead to uneven water distribution and therefore less efficient operation.

#### WATER TANK

It is important to keep the water tank clean and free from sediment and algae growth. To clean the tank, use a soft brush or similar. Wipe all surfaces in the tank while it is full of water (DO NOT FORGET THE PUMP STRAINER). Turn off the water inlet to the unit (an Isolation Valve should be fitted to the water inlet before the Float Valve). Drain the tank by removing the 40mm standpipe. It may be necessary to repeat this procedure if the tank is very dirty.

**SAFETY: Wet roofs are dangerous – Take Care When Draining Tank.**

#### WATER LEVEL / FLOAT VALVE

The water level should be set at nominal 65-70mm from the top of the overflow before filter pads are saturated. After run off from operating filters the level from the top of the overflow fitting should be 25 – 30mm. The float valve is a mechanical type and is factory set. If it requires adjustment keep bends tight. If the valve is leaking the seal may require cleaning or replacing. Turn off the water. Remove the split pin and then float arm. Remove piston and clean or turn seal. Flush system and replace piston, float arm and split pin.

**Note: Water supply line to float valve must be flushed before connecting.**

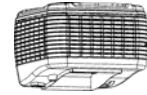

---

## Ducted Evaporative Air Conditioning

---

**Note: Some discharge from the overflow may be experienced after shut down due to water draining back from the Celdek pads. This is normal.**

### MOTOR AND FAN

Check that the fan spins freely and that there is no build up on the blades.

### ELECTRICAL

No general maintenance is required to the electrical system.

A Qualified Electrician should only carry out electrical connections and maintenance.

### BLEED OFF

The bleed rate should be checked to ensure it is adequate and that there is no build up of mineral deposits in or on your air conditioner. White deposits indicate high mineral content and the Bleed Rate should be increased. If it is at maximum and the deposits are still forming, then more regular maintenance is required.

### PUMP

Check the pump spins freely and that the strainer is clean.

### WATER DISTRIBUTION

Check the water distribution system for blockage. Check the delivery tube for kinks or holes. Check that the clamps are secure and in place.

### NO SEASONAL MAINTENANCE

Your unit has been supplied with a dump valve system. As long as the dump valve has been fitted, there is no need for regular checking of the system during the operating (summer) period. This however does not remove the responsibility of the customer to have the unit service on an annual basis to check the unit function and to ensure the unit is clean and free from any mineral deposit build up.

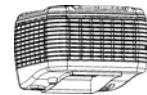

## Ducted Evaporative Air Conditioning

### PROBLEM SOLVING

PROBLEM	PROBABLE CAUSE	REMEDY
<b>Unit fails to start</b>	<ul style="list-style-type: none"> <li>a Black – out</li> <li>b Tripped Circuit Breaker</li> <li>c Blown Fuse</li> <li>d Electrical Fault</li> </ul>	<ul style="list-style-type: none"> <li>a Wait</li> <li>b Reset</li> <li>c Replace</li> <li>d Call Climate Technologies Service Provider</li> </ul>
<b>Pump fails to start</b>	<ul style="list-style-type: none"> <li>a Pump Seized</li> <li>b Pump Burnt Out</li> </ul>	<ul style="list-style-type: none"> <li>a Isolate power and then take off top of pump and try to free it. Some lubricant may help.</li> <li>b Call Climate Technologies Service Provider</li> </ul>
<b>Water leaking from overflow</b>	<ul style="list-style-type: none"> <li>a Float Valve Leaking</li> <li>b Drain from Celdek Pads</li> </ul>	<ul style="list-style-type: none"> <li>a Check adjustment or replace seal</li> <li>b Normal Operation</li> </ul>
<b>Water Droplets in air stream</b>	<ul style="list-style-type: none"> <li>a Loose Delivery Tube</li> <li>b Break in tubing</li> <li>c Pump Delivers Excessive Water to Pads</li> </ul>	<ul style="list-style-type: none"> <li>a Check and tighten</li> <li>b Replace as necessary</li> <li>c Adjust the Dialflo to reduce the flow</li> </ul>
<b>Excessive humidity</b>	<ul style="list-style-type: none"> <li>a Inadequate Exhaust</li> <li>b Outside humidity high</li> </ul>	<ul style="list-style-type: none"> <li>a Provide more open area to exhaust stale air</li> <li>b Turn pump off.</li> </ul>
<b>Inadequate Cooling</b>	<ul style="list-style-type: none"> <li>a Dirty Filters</li> <li>b Dry Filters</li> <li>c Dialflo not set correctly</li> </ul>	<ul style="list-style-type: none"> <li>a Clean</li> <li>b Check water delivery system. Adjust if necessary.</li> <li>c Adjust Dialflo so that the pads have even saturation.</li> </ul>
<b>Unpleasant Odor</b>	<ul style="list-style-type: none"> <li>a Unit located near odor source</li> <li>b New Celdek filter smell</li> </ul>	<ul style="list-style-type: none"> <li>a Remove source</li> <li>b Smell will disappear after a period of operation.</li> </ul>
<b>Rapid formation of white deposits on pads</b>	High Mineral Content	Bleed off should be set at maximum. More regular maintenance may be required.

THIS TROUBLE SHOOTING GUIDE IS A REFERENCE ONLY.

FOR SERVICE OR WARRANTY REQUIREMENTS PLEASE REFER  
TO THE LAST PAGE OF THESE INSTRUCTIONS



# Unit Setup

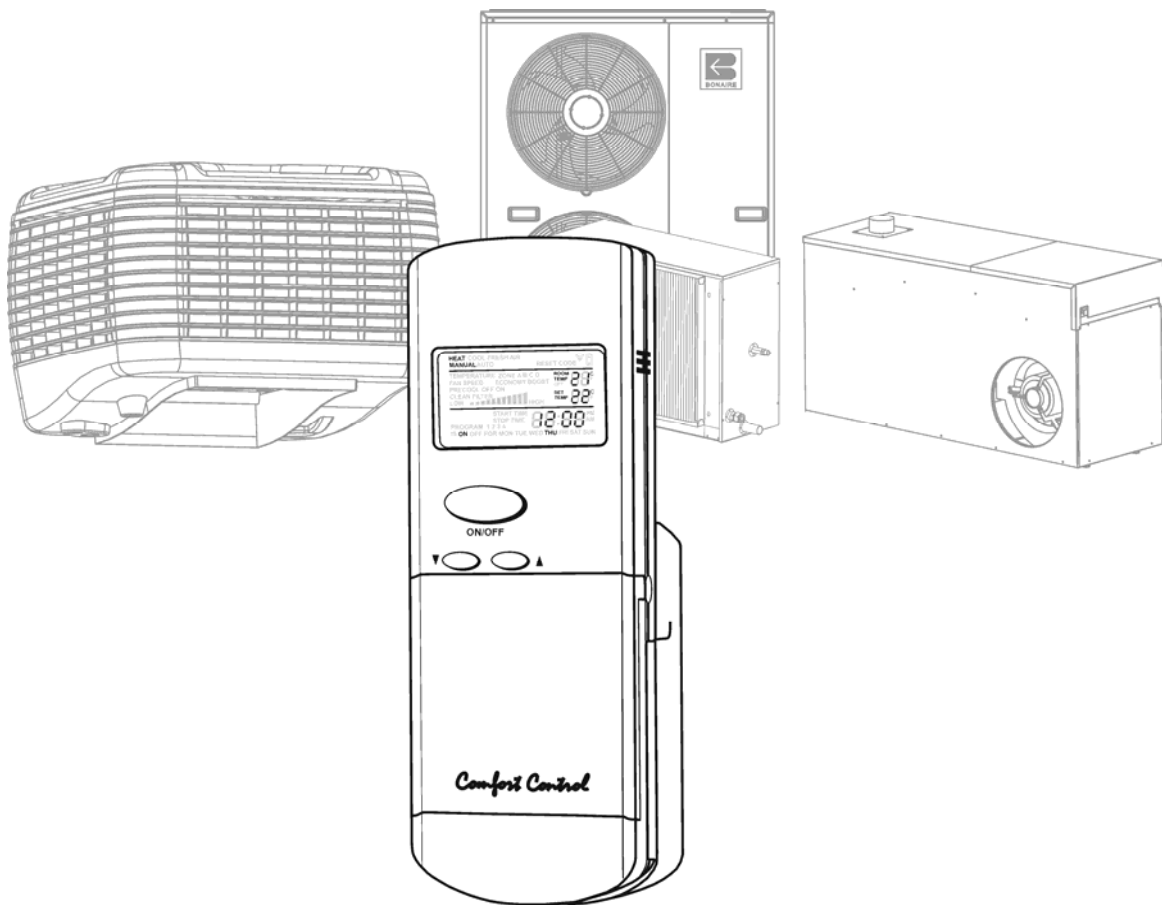



## Controls- Installation / Setup / Commissioning

### SETTING UP THE CONTROL - GENERAL

#### *BEFORE STARTING*

Before attempting to use the setup instructions for the controls system, make sure the antenna (RF units only) or the low voltage cable is connected, batteries have been correctly installed in the remote control (RF units only) and the 240 volt power has been turned on to the product.

**NOTE: Do not run the low voltage loom in long parallel runs with 240V mains cables. Keep the low voltage loom 200mm away from any long runs of mains wiring.**

**Cross over mains wiring at right angles.**

**Do not use existing access holes in wall cavities where 240V mains wiring exist. Drill a new access hole 200mm from the existing hole.**

#### **INSTALLATION**

Where the control is using the thermostat for operation, it must be installed approximately 1.5 metres above the floor level on a room wall which is most commonly used for best average sensing.

Secure the Comfort Control cradle to the wall using the screws and plugs provided.

- For hard wired versions drill an access hole through the cradle to bring the cable into the control. Once connected snap the control into the cradle.
- For radio frequency controls install batteries and slide the Comfort Control into the cradle. The Comfort Control should remain in the cradle during normal operating conditions for optimum temperature thermostat control.



Do not locate Comfort Control near concealed hot or cold water pipes, warm air ducts, radiators, sunlight, televisions or draughts from hallways, stairways and fireplaces. These can all affect the temperature.

#### **RF Control Units ONLY**

Ensure the antenna has been installed at least 500 mm clear of all metal masses. The transmissions between the RF Remote Control and the unit control box are radio signals which are subject to interference. The primary causes for signal interference are:

- Metal Construction buildings or metal masses near the antenna.
- Incorrect location of the antenna
- Cordless RF door bells
- Other Faulty appliances
- Remote Control too close to computers
- Powerful radio scanners

If transmission cannot be achieved successfully a Low voltage cable control will need to be installed by the installer.



## Controls- Installation / Setup / Commissioning

### CODING THE UNIT

There is a 4 minute window from the timer the 240V has been turned on to the control board in which to code the unit.

1. Turn the 240V power ON to the unit. If the power has already been applied, turn the power OFF, then ON again.
2. Press the ▲ arrow and the ON/OFF button for 5 seconds until the word “CODE” flashes.
3. Code flashes for 15 seconds. When code stops flashing the unit is now ready to turn on.

### CHECKING THE SIGNAL – RF REMOTE CONTROL ONLY.

There are 3 ways you can check if the wall control is communicating with unit control board.

1. The green light on the unit control board will flicker when receiving a signal.
2. The transmission symbol on the control will show for a flash only. If it hangs for approximately 2 seconds there is no transmission.
3. Press the **MANUAL/AUTO** and **CLEAN FILTER/ZONE ABCD** for 15 seconds.
  - If the 2 dots between the hours and the minutes flash together signal OK. If the 2 dots alternate there is no communication.
  - Press **ENTER** in each location to check the signal.
  - The test function stays active for 5 minutes after the last time ENTER is pressed. Where there is no signal, re-coding the unit.

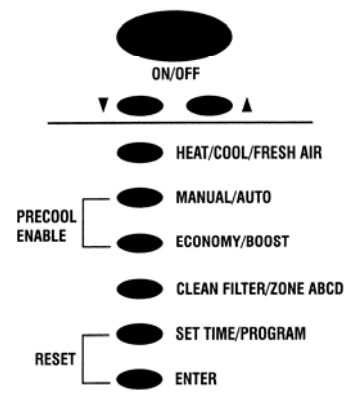

### CHANGING THE CODE

It is possible for the Code (digital address) to be duplicated in another installation nearby which will interfere with the successful operation of your unit. To change the code:

1. Turn the electricity to the unit OFF, then ON.
2. Press the **HEAT/COOL/FRESH AIR** button and the **ON/OFF** button for 5 seconds until the words SET CODE and 4 digits show.
3. Each digit can be altered using the ▼ or ▲ buttons. Press **ENTER** after each digit or digit change. When all digits have been changed the word CODE will appear briefly until the update has taken place.

There is a 4 minute window in which to code the unit. Code flashes for 15 seconds. When code stops flashing the unit is now ready to turn on.

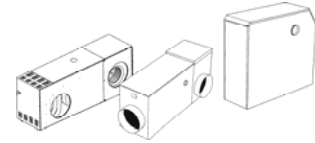

**Controls- Installation / Setup / Commissioning**

**SETTING UP THE CONTROLS – DUCTED GAS CENTRAL HEATING**

**SETTING MINIMUM FAN SPEED**

1. Using the **MANUAL/AUTO** button set the unit to MANUAL.
2. Using the **ECONOMY/BOOST** button set the unit to ECONOMY.
3. Press the **ENTER** and **ECONOMY/ BOOST** buttons for approximately 10 seconds pressing the ENTER button first.
4. The words FAN SPEED and a number under the room temperature will flash.
5. Adjust minimum fan speed to 27 or a number suitable that the heater does not go out on over-temperature.

Press **ENTER** to keep new fan speed.

**SETTING MAXIMUM FAN SPEED**

1. Using the **MANUAL/AUTO** button set the unit to MANUAL
2. Using the **ECONOMY/BOOST** button set the unit to BOOST
3. Press the **ENTER** and **ECONOMY/ BOOST** buttons for approximately 10 seconds pressing the ENTER button first.
4. The words FAN SPEED and a number between the 2 bars will flash.
5. Adjust maximum fan speed to 35 or a number suitable that the unit does not go out on over-temperature.

Press **ENTER** to keep new fan speed.

Setting the fan speeds to a low setting should be completed by an authorised installer / service technician. Motor warranty may be voided for incorrect settings.

**SETTING THE ZONE AVAILABILITY**

The unit default is for all zones to be available. To filter out the zones not being used:

1. Press the **ENTER** and **CLEAN FILTER/ZONE ABCD** buttons for 10 seconds pressing the ENTER button first.
2. Using the ▼ or ▲ buttons select the zone combination required AB, ABC or ABCD.
3. Press **ENTER** to keep the combination.

Now only the zone combination selected will be available for use when operating the zone requirements.

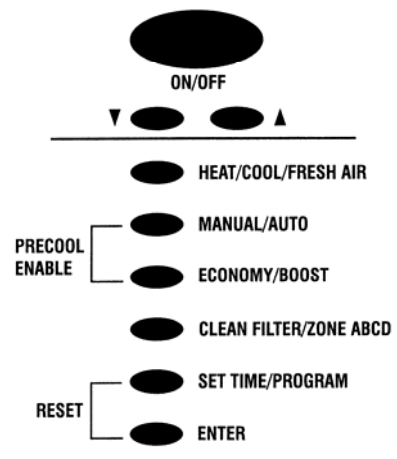



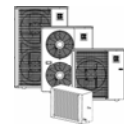

## Controls- Installation / Setup / Commissioning

### SETTING UP THE CONTROLS – DUAL CYCLE REFRIGERATIVE AIR CONDITIONING

The PNE control board in the Bonaire Central Heating units, has the option to run the room air fan in continuous mode or cycling OFF / ON with the dual cycle refrigerative condenser unit.

#### SETTING THE FAN CONTROL FROM AUTO TO CONTINUOUS MODE

##### SETTING PROCEDURE

To alter the fan operation mode, you will need to change the screen display to reflect evaporative air conditioning **COOL FRESH AIR** for a short period of time.

- Step 1** Using the HEAT / COOL / FRESH AIR button set the unit operation to **COOL** (for dual cycle refrigerative air conditioning) only.
- Step 2** Press and hold down the HEAT / COOL / FRESH AIR and the ECONOMY / BOOST BUTTONS for approximately 5 seconds and the screen display will change to **COOL FRESH AIR**.
- Step 3** Setting the fan cycle mode
1. Make sure the controller is in **MANUAL** mode and is set to **COOL FRESH AIR**.
  2. Press the ENTER button and the MANUAL / AUTO buttons together for 10 seconds pressing the ENTER button first. The word **OPT** and some numbers will flash on the screen.
  3. Using the ▼ or ▲ buttons make the top number read **02**. Press ENTER.
  4. Using the ▼ or ▲ buttons change the number of the second line to **01**. Press ENTER.

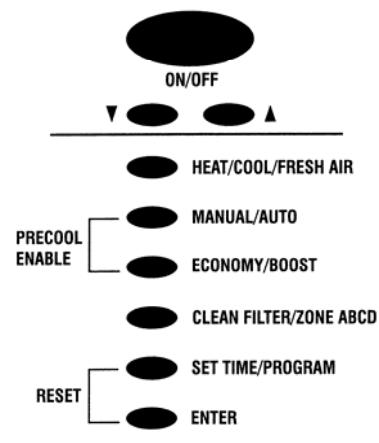

The central heater fan is now set to “continuous operation” for the dual cycle refrigerative air conditioning.

- Step 4** Turn the controller **OFF** then **ON** again to transmit the new information to the heater control board.
- Step 5** Finally, you will need to change the screen back to **COOL** for dual cycle refrigerated air conditioner mode. Ensure the screen displays COOL FRESH AIR.

Press and hold down the HEAT / COOL / FRESH AIR and the ECONOMY / BOOST BUTTONS for approximately 5 seconds and the screen display will change to **COOL**.

The central heater fan is now set to “continuous operation” for the dual cycle refrigerative air conditioning. The room air fan will now run continuously and the condenser will cycle on and off.

As the add-on cooler is an add-on to your ducted gas central heater there are no further setup functions to be completed.

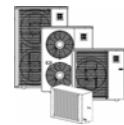

## Controls- Installation / Setup / Commissioning

### SETTING THE FAN CONTROL FROM CONTINUOUS TO AUTO MODE

#### SETTING PROCEDURE

The comfort control should be in the COOL (for Refrigerative air conditioning) and the manual mode.

To alter the fan operation mode, you will need to change the screen display to reflect evaporative air conditioning **COOL FRESH AIR** for a short period of time.

- Step 1** Using the HEAT / COOL / FRESH AIR button set the unit operation to **COOL** (for dual cycle refrigerative air conditioning) only. Press Enter.
- Step 2** Press and hold down the HEAT / COOL / FRESH AIR and the ECONOMY / BOOST BUTTONS for approximately 5 seconds and the screen display will change to **COOL FRESH AIR**.
- Step 3** **Set the fan cycle mode**

1. Make sure the controller is in **MANUAL** mode and is set to **COOL FRESH AIR**.
2. Press the ENTER button and the MANUAL / AUTO buttons together for 10 seconds pressing the ENTER button first. The word **OPT** and some numbers will flash on the screen.
3. Using the ▼ or ▲ buttons make the top number read **02**. Press ENTER.
4. Using the ▼ or ▲ buttons change the number of the second line to **00**. Press ENTER.

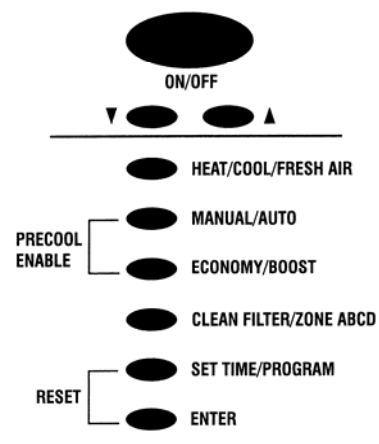

**Step 4** Turning the controller **OFF** then **ON** will transmit the new information to the heater control board.

**Step 5** Finally, you will need to change the screen back to **COOL** for dual cycle refrigerated air conditioner mode. Ensure the screen displays COOL FRESH AIR.

Press and hold down the HEAT / COOL / FRESH AIR and the ECONOMY / BOOST BUTTONS for approximately 5 seconds and the screen display will change to **COOL**.

The central heater fan is now set to “auto operation” for the dual cycle refrigerative air conditioning. The room air fan will now cycle on and off with the dual cycle refrigerative condensing unit. Please note there will be time delays with the on and off cycling of the refrigerative condensing unit.

#### SETTING MINIMUM FAN SPEED

The add-on cooling only has one speed of operation.

#### SETTING MAXIMUM FAN SPEED

There is no maximum speed adjustment as the add-on cooler default is maximum speed.

#### SETTING THE ZONE AVAILABILITY FILTER

This will be the same setup as already available for Ducted Gas Central Heating.

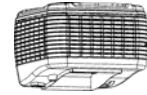

## Controls- Installation / Setup / Commissioning

### SETTING UP THE CONTROLS – DUCTED EVAPORATIVE AIR CONDITIONING

#### SETTING MINIMUM FAN SPEED

1. Using the **MANUAL/AUTO** button set the unit to MANUAL
2. Using the **HEAT/COOL/FRESH AIR** button set the unit to COOL FRESH AIR
3. Adjust the fan speed to the minimum fan speed level and press ENTER.
4. Press the **ENTER** and **ECONOMY/ BOOST** buttons together for approximately 10 seconds pressing the ENTER button first.
5. The words FAN SPEED and a number under the room temperature will flash.
6. Adjust minimum fan speed to a number suitable to the system design. Ensure that the motor does not over-temp if setting the fan speed lower.
7. Press **ENTER** to keep new fan speed.

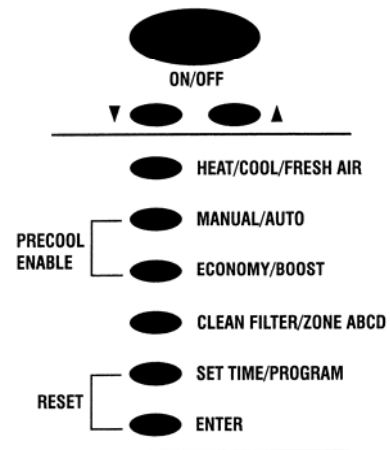

#### SETTING MAXIMUM FAN SPEED

Maximum fan speed can only be access after the minimum fan speed has been checked.

1. Using the **MANUAL/AUTO** button set the unit to MANUAL.
2. Using the **HEAT/COOL/FRESH AIR** button set the unit to COOL FRESH AIR.
3. Using the **ECONOMY/BOOST** button set the unit to BOOST. Press ENTER.
4. Press the **ENTER** and **ECONOMY/ BOOST** buttons together for approximately 10 seconds pressing the ENTER button first.
5. The words FAN SPEED and a number under the room temperature will flash.
6. Adjust maximum fan speed to 35 or a number to suit the system design.
7. Press **ENTER** to keep new fan speed.

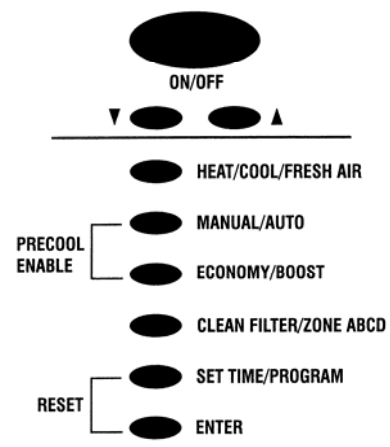

Setting the fan speeds to a low setting should be completed by an authorised installer / service technician. Motor warranty may be voided for incorrect settings.

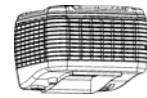

## Controls- Installation / Setup / Commissioning

### SETTING UP THE DUMP VALVE (WHERE FITTED)

Dump valve settings have two parts to the setup.

- Setting the dumping cycle time
- Setting the Dump OFF delay time.

#### SETTING THE DUMP OFF DELAY TIME.

Dump OFF Delay Time gives the option for immediate dumping of the water from the Tank or a one hour delay after the unit has been turned OFF. Setting the 1 hour delay is preferable if the unit is going to be used in thermostat (AUTO) mode. To set the 1 hour delay:

1. Make sure the unit is in MANUAL mode and is set to COOL FRESH AIR.
2. Press the **ENTER** button and the **MANUAL/AUTO** buttons together for 10 seconds. Press the ENTER button first. The word OPT and some numbers will flash on the screen.
3. Using the ▼ or ▲ buttons make the top number read 00. Press **ENTER**.
4. Using the ▼ or ▲ buttons change the number of the second line to 01. Press **ENTER**.

The one hour delay is now set.

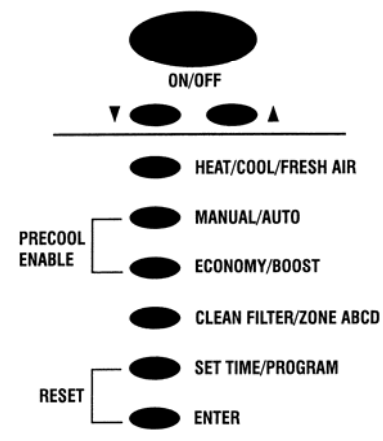

#### SETTING THE DUMPING CYCLE TIMES

1. Make sure the unit is in MANUAL mode and is set to COOL FRESH AIR.
2. Press the **ENTER** button and the **MANUAL/AUTO** buttons together for 10 seconds. Press the ENTER button first. The word OPT and some numbers will flash on the screen.
3. Using the ▼ or ▲ buttons make the top number reads 01. Press **ENTER**.
4. Using the ▼ or ▲ buttons change the number of the second line to hourly required between dumping the water from the tank. Press **ENTER**. Dumping Cycles can be 0, 1, 2, 4, 8, 12, 24 hours.

The dumping cycle times have now been set.



---

## **COMMISSIONING CHECK LIST**

### *GENERAL*

- All equipment ordered by the customer is installed.
- The unit is level and secure.
- The mains and control wiring are complete and the circuit breaker and GPO are turned ON.
- All Controller functions for the appliance operate.
- All electrical or gas connections are to manufacturers specifications and the relevant electrical or gas standards and codes.

### *DUCTED EVAPORATIVE AIR CONDITIONER UNIT*

- The water supply line has been flushed to clear swarf and debris and is free of leaks.
- The tank is free of foreign matter and debris and the water isolating tap is turned ON.
- Water drainpipe work is completed and sealed.
- The water basin fills with water and the float valve closes correctly when the water level is 65-70mm below the overflow level.
- The water pump operates correctly when turned ON at the controller.
- The Dialflo water bleed rate is adjusted to suit local water conditions.
- The Superclean Dump Valve (option). The tank drains correctly when unit turns off.
- The fan deck is correctly located and the fan blade spins freely.
- The fan operates through the entire speed range.
- The minimum fan speed is correctly set.
- Water distribution is even with the filter pads fitted and the air conditioner operating pump and fan.

### *DUCTED HEATING UNIT*

- Electrical polarity of the power outlet is correct.
- Heater is installed away from sources of dust and fumes (i.e. pool chlorine/petrol etc).
- Gas leaks checked for, none present.
- Flue outlet pipe complies with limits given / code and is sealed waterproof.
- Combustion air meets requirements (internal, under floor).

## Controls- Installation / Setup / Commissioning



- Fan speed set is correct.
- Burner pressure is correct.
- Mounting pad/platform complies with requirements / codes.

### *ADD-ON REFRIGERATED AIR CONDITIONING UNIT*

- Unit Foundation correct
- All pipe work is welded and vacuumed down.
- Condenser Coil is purged before charging.
- System is charged, all joints checked and pressures set correctly
- Condenser unit is level
- All clearances around the condenser set to manufacturer's specifications.

### *DUCTWORK*

- All ductwork is completed to plan, correctly supported and airtight, with no bend less than 1.5 x the ductwork diameter.
- Air distribution checked, dampers are adjusted and all outlets correctly adjusted and wiped clean.
- All roof penetrations are fully sealed and watertight.
- Manhole cover replaced.

### *SITE*

- All rubbish has been removed from inside and on the roof.

### *CUSTOMER HAND OVER*

- The operation of the Controller.
- The need to open windows and doors for the correct operation of Fresh Air Conditioning
- The operation of the bleed or dumping system and it's importance to operate all the time in ducted fresh air conditioning
- Maintenance requirements

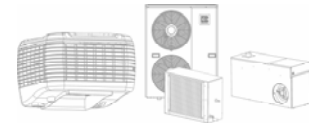

## Warranty – Australia ONLY

---

### IMPORTANT:

Please read this warranty information and complete the Dealer/Product information on the following page. KEEP this with your original purchase documents for any claim under warranty. Firstly refer to your owners manual to ensure you have followed the correct operating procedures of your product, and refer to the trouble shooting guide to assist solving any problems you may have.

1. Read this warranty statement carefully before you request warranty service as items relation to installation are not covered by this appliance warranty.
2. A proof of product purchase must be provided for warranty service, to validate the appliance is within the manufacturer's warranty periods.
3. This warranty is only for products and associated original controls for Climate Technologies manufactured product.
4. Only an authorised Climate Technologies service provider must carry out warranty service.

Climate Technologies provides the following Manufacturers warranty additional to all implied warranties and other statutory rights which you may have under the Trade Practices Act and similar State & Territory Laws, subject to the following terms and conditions.

### Conditions to warranty

- Subject to the exclusions noted, Climate Technologies warrant the product for the period as prescribed in the table following this statement to be free from Inherent defects in materials and workmanship for functional and structural components.
- This product is only valid if the product is operated in accordance with the manufacturers instructions
- The appliance must not be modified or changed in any way.
- Your proof of purchase MUST be produced before free service will be provided.
- Traveling time and mileage are included within 30km of either your authorised Climate Technologies dealer or service provider's premises. Customers in areas other than the above are responsible for any traveling time and mileage required to carry out warranty repairs.
- The product must be installed by a qualified person in the manner prescribed by local & statutory regulations and to the manufacturer's specifications.
- Service within the terms of this warranty will be recognised where we are satisfied that the appliance or part was supplied within the relevant time limits. Documents of purchase and Dealer/Installer information will assist in this process.
- Product fitness for purpose and overall system design / sizing is solely the responsibility of the dealer / installer. This includes but is not limited to heat load calculations, air flow, system balancing, humidity, water quality etc.
- The product must be installed in an easily and safe accessible area for service, appliances installed in areas not easily and safely assessable, costs will be borne by the owner for access equipment should maintenance be required.

### DIY installation Warranty

- If the product has been installed as a DIY, a supply part only warranty will apply. Parts only will be supplied free of charge on the return of the faulty part and the owner will be responsible for all labour charges incurred for the part to be fitted by a qualified person. Labour warranty as prescribed in the following table is void in this situation.

### Remote Location Warranty

- If the product has been installed outside the Climate Technologies service network, a supply part only warranty will apply. Parts only will be supplied free of charge on the return of the faulty part and the owner will be responsible for all labour charges incurred for the part to be fitted by a qualified person. Labour warranty as prescribed in the following table is void in this situation.

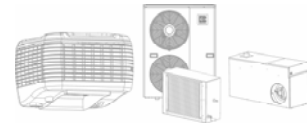

## Warranty – Australia ONLY

---

### Exclusions to warranty.

- Consumable items subject to wear and tear such as filter pads, drive belts and bearings are not covered by this warranty.
- Components used as part of the installation such as grilles filters, ducting, fittings, zone motors and consumer services pipe work are warranted from your place of purchase and not covered by this warranty.
- Damage caused by elements such as wind, rain, lighting, floods etc along with power spiking and brownouts are not considered defective material or workmanship and as such are not considered warranty.
- No responsibility will be accepted for outside elements such as pests, animals, pets and vermin that may cause damage to the unit.
- Harsh environmental situations such as salt air that may cause cabinet damage / rusting can not be considered warranty.
- The manufacturer does not accept liability or any claims for damage to building contents, carpet, walls, ceilings, foundations or any other consequential loss either direct or indirect. Damage resulting from, power spikes, incorrect operation, incorrect installation, incorrect maintenance is also not covered.
- All warranties are NOT transferable.

### Conditions where warranty may be void.

- If there is no certificate of compliance for plumbing, electrical or refrigeration as required by State & Territory Laws. Climate Technologies reserves the right to refuse service on non-compliant installations.
- The defective operation of the appliance that is due to failure of electricity, gas, water or refrigerant gas supplied.
- Defects are caused by neglect, incorrect application, abuse or by accidental damage of the appliance.
- An unauthorised person has attempting to repair the appliance.
- A situation arises referenced in the trouble-shooting guide.
- A charge will be made for work done or a service call where there is nothing wrong with the appliance.

### AGED NEW PRODUCT WARRANTIES

For a New Product warranty to apply, a product needs to be sold and installed within 3 years of the manufacturing date.

Product that is aged as the result of extended storage or being used for demonstration purposes, the following warranty will apply.

- For a product that is greater than 3 years and less than 5 years old from date of manufacture the statutory warranty will apply and any voluntary warranty originally supplied will be reduced by 1 year
- For a product that is greater than 5 years of age from date of manufacture, the statutory warranty will apply to electrically functioning components only. All other components being cabinets, louvres, filters etc. will not be covered by warranty.



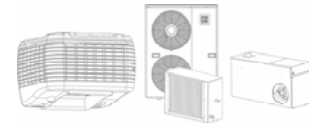

## Warranty – Australia ONLY

### PERIODS OF WARRANTY – YEARS BY PRODUCT AND APPLICATION:

#### DUCTED GAS HEATING

Unit Components	RESIDENTIAL		COMMERCIAL	
	Parts	Labour	Parts	Labour
Heat Exchanger	10	3	2	2
Burner	10	3	2	2
**All other components	3	3	1	1

\*\* Return air filter/s and zone motors are field supplied and therefore are not covered by the above warranty periods.

#### DUAL CYCLE REFRIGERATED AIR CONDITIONING

Unit Components	RESIDENTIAL		COMMERCIAL	
	Parts	Labour	Parts	Labour
Compressor	5	5	2	2
All other components	5	5	2	2

\*\* RETURN AIR FILTER/S AND ZONE MOTORS ARE FIELD SUPPLIED AND THEREFORE ARE NOT COVERED BY THE ABOVE WARRANTY PERIODS.

#### DUCTED EVAPORATIVE AIR CONDITIONING - DOMESTIC

Unit Components	RESIDENTIAL		COMMERCIAL	
	Parts	Labour	Parts	Labour
Corrosion on Cabinet	25	3	2	2
Structural Guarantee	10	3	2	2
** All other components	3	3	1	1

\*\* Filter pads are a consumable and are therefore not covered by this warranty

### 2 Year Extended Warranty

Where a 2 year extended warranty has been sold / provided, a validation service must be conducted during the 3<sup>rd</sup> year of the product's life. The validation service form must be signed by a Climate Technologies service technician or a Climate Technologies approved service provider for any warranty work to be valid during years 4 and 5 of the product life.

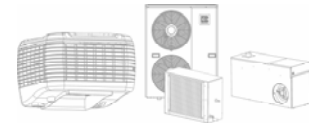

**Warranty – Australia ONLY**

**WARRANTY ON REPLACEMENT PARTS:**

Parts replaced under warranty are warranted for the balance of the original warranty period.

**PROOF OF PURCHASE:**

It is important that the name of the Dealer or Retailer from whom you purchased your product and the name of the installer are recorded on this page. The installer is responsible for the correct installation, start up and demonstrating the operation of this product. The Dealer or retailer is also responsible for issuing the relevant certificates of compliance for the electrical connections. (These may differ from state to state)

Please attach your proof of purchase here. Your receipt is your warranty and will be required to validate any warranty.

**DEALER PRODUCT INFORMATION:**

Dealer/Retailer:	
Dealer Address:	
Dealer Phone Number:	
Unit Model Number:	
Serial No:	
Date Installed:	
Installed by:	
Date Commissioned:	
Commissioned by:	Signature:

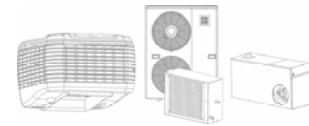

**Service**

**SERVICE CENTRES:**

Only qualified service personnel should conduct any service work carried out on your ducted reverse cycle air conditioning system. It is important that periodical service is carried out on your product to ensure you will receive the efficiency benefits the product provides.

For Metro Service only ring the numbers below.

**South Australia/  
Northern Territory** (08) 8307 5230

**New South Wales /  
Australian Capital Territory** (03) 8795 2457

**Western Australia** (08) 9454 1000

**Victoria/Tasmania** (03) 8795 2456

**Queensland** (03) 8795 2457

Outside Metro areas please contact your nearest Climate Technologies Service Provider.

**New Zealand (ABERGAS LTD)** 0800 161 161



*“Excelling today for a better tomorrow”*

Manufactured by  
**Climate Technologies**  
ABN 13 001 418 042

26 Nylex Avenue  
Salisbury, SA 5108  
Australia

[www.climatetechnologies.com.au](http://www.climatetechnologies.com.au)