

Owner's Manual

Using the
Ducted Gas Central Heating
Dual Cycle Refrigerated Air Conditioning
Ducted Evaporative Air Conditioning

with your

multi-appliance
Navigator Controller

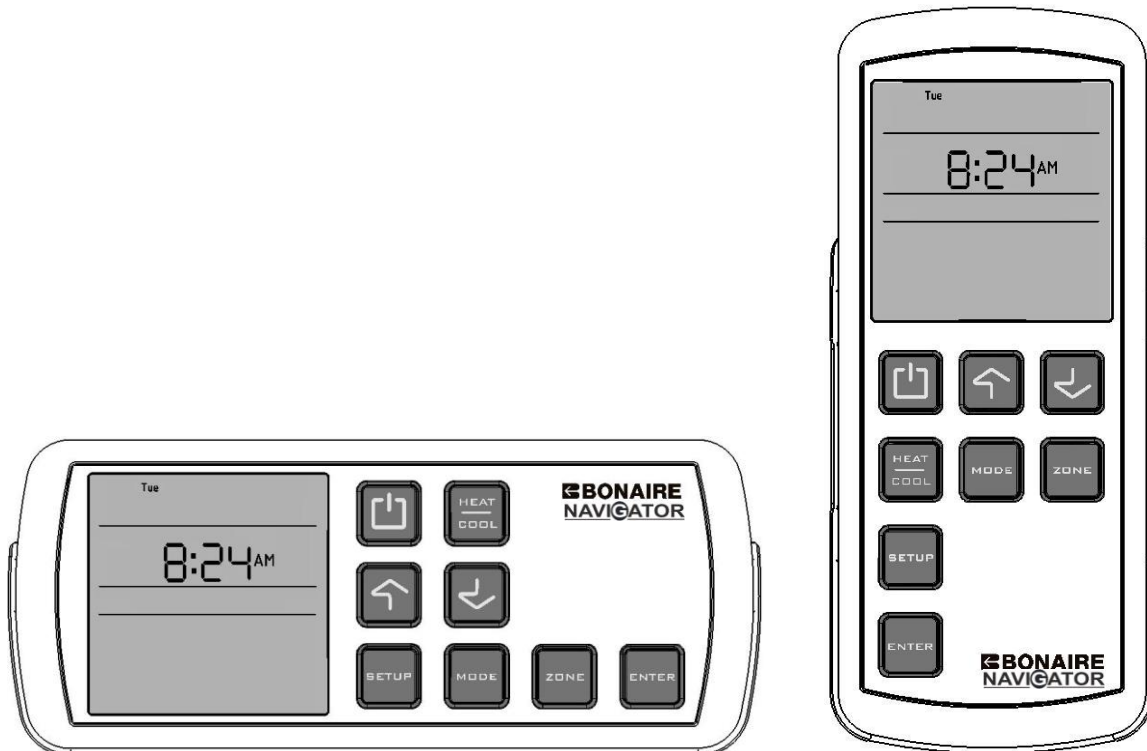

Wired Wall Mounted and Wireless Remote Control`

Please keep this important manual in a safe place. It is the owner's responsibility to ensure that regular maintenance is carried out on units. Failure to do so will void all guarantees beyond statutory and legal requirements.

www.climatetechnologies.com.au

Contents

INTRODUCTION..... 4

1. YOUR MULTI-APPLIANCES CONTROLLER 4

2. GENERAL INFORMATION..... 5

 IMPORTANT INSTALLATION NOTICE 5

 MODEL & SERIAL NUMBER..... 5

 LIMITATIONS..... 5

 WARRANTY..... 5

NAVIGATING THE CONTROLS 6

3. TYPES OF NAVIGATOR CONTROLLER 6

4. FEATURES OF THE NAVIGATOR CONTROLLER..... 7

5. USING THE 8 BUTTONS 8

6. THE LCD DISPLAY 9

7. BACKLIGHT..... 9

8. REMOTE TRANSMISSION 9

9. SETTING THE DAY AND TIME..... 10

10. SIMPLE MANUAL OPERATION (Heating or Cooling) 11

11. APPLIANCE TYPE SELECTION 11

12. CHILD LOCK 12

DUCTED GAS CENTRAL HEATING 13

13. GENERAL INFORMATION..... 14

 IMPORTANT NOTICE 14

 ASSEMBLY..... 14

14. SAFETY 15

 SAFETY & OWNER RESPONSIBILITY..... 15

 PRECAUTIONS 15

 FEATURES..... 15

 POWER OR GAS INTERRUPTION..... 15

15. USING YOUR NAVIGATOR CONTROLLER 16

 MANUAL CONTROL..... 16

 ECONOMY MODE..... 17

 FAN MODE 18

 ZONING (IF INSTALLED)..... 18

 PROGRAMMING YOUR NAVIGATOR CONTROLLER 19

16. HEATER MAINTENANCE 21

17. SCHEDULED MAINTENANCE..... 21

18. PROBLEM SOLVING 22

DUAL CYCLE REFRIGERATED AIR CONDITIONING 23

19. GENERAL INFORMATION..... 24

 IMPORTANT NOTICE 24

 MODEL & SERIAL NUMBER..... 24

 ASSEMBLY..... 24

20. SAFETY 24

 SAFETY & OWNER RESPONSIBILITY..... 24

 PRECAUTIONS 24

 FEATURES..... 24

 POWER INTERRUPTION..... 24

21. USING YOUR NAVIGATOR CONTROLLER 25

 COOLING 25

 HEATING 25

 HEAT & COOL 25

Contents

ZONING	26
22. PROGRAMMING YOUR NAVIGATOR CONTROLLER.....	26
USING THE PROGRAMMING SEQUENCE.....	26
DUCTED EVAPORATIVE AIR CONDITIONING	27
23. INTRODUCTION	28
24. UNIT OPERATION	28
EXHAUST	28
WATER MANAGEMENT	29
25. USING YOUR NAVIGATOR CONTROLLER	30
MANUAL MODE	30
THERMO MODE.....	30
BOOST MODE.....	31
FAN MODE	31
PINNACLE ADDITIONAL FEATURES.....	31
26. TIMED OPERATION.....	32
27. DUCTED EVAPORATIVE AIR CONDITIONER MAINTENANCE	33
SERVICE ICON	33
FILTER PADS	33
WATER TANK.....	33
MOTOR AND FAN	34
ELECTRICAL	34
BLEED OFF	34
PUMP.....	34
WATER DISTRIBUTION	34
NO SEASONAL MAINTENANCE	34
28. PROBLEM SOLVING	35
APPLIANCE WARRANTY – AUSTRALIA ONLY (2012).....	36

Introduction

1. YOUR MULTI-APPLIANCES CONTROLLER

You have chosen one of the world's most advanced control systems. The Navigator Controller is intended for use in controlling BONAIRE Gas Heaters, Evaporative Coolers or Dual Cycle Refrigerated Coolers.

The Navigator Controller can control multiple units.

Your Navigator Controller has been designed to operate various BONAIRE products:-

HEATING – MB-3, 4 & 5 Star BONAIRE Ducted Gas Central Heaters.

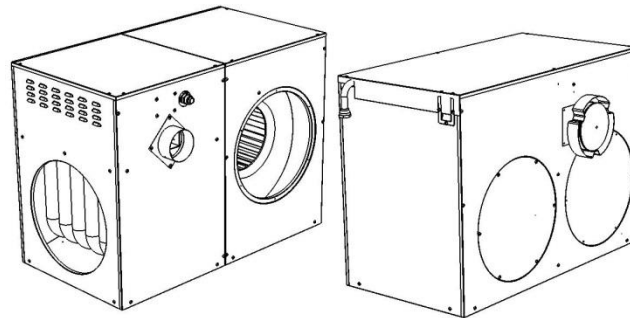

DUAL CYCLE HEATING & COOLING – A BONAIRE Gas Central Heater with a matched BONAIRE Dual Cycle Refrigerative Cooling System attached.

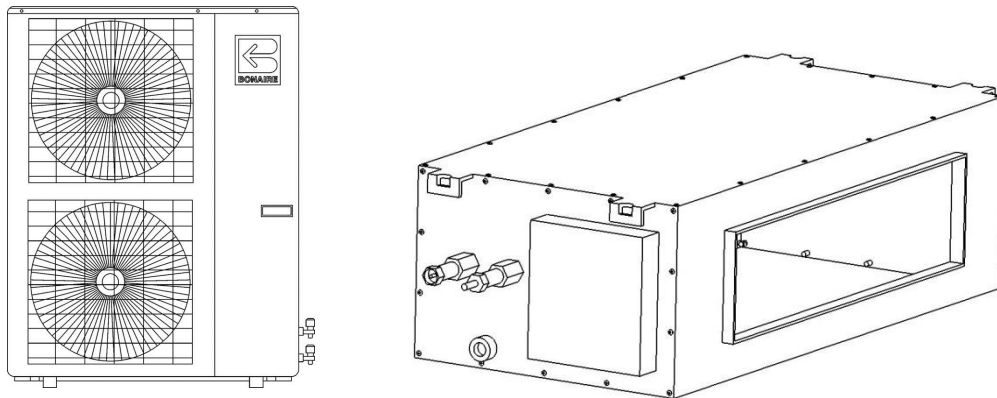

FRESH AIR CONDITIONERS – BONAIRE Ducted Evaporative Air Conditioners.

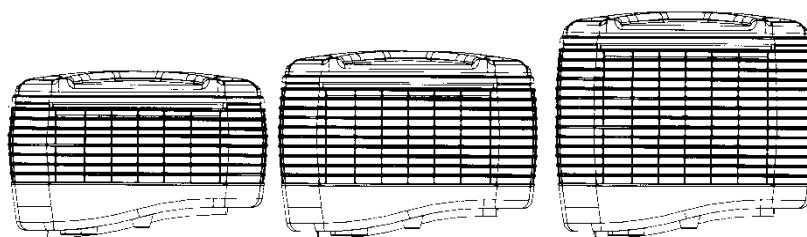

Introduction

Your Navigator Controller is available in two versions -

1. Wall Mounted Control (Wired)
2. Remote Control (Wireless)

These operating notes cover both versions. Whether hand held or wall mounted, take advantage of the versatility your Navigator Controller offers.

Use your Navigator Controller to reduce your energy bills by selectively conditioning part of or your entire home at an economical reduced rate or by setting programs to suit your needs (Not available on Evaporative Air Conditioning).

Your Navigator Controller is designed in Australia to suit Australian conditions and will ensure that your home is comfortable all year round.

2. GENERAL INFORMATION



IMPORTANT INSTALLATION NOTICE

A licensed person is required to install BONAIRE equipment. If the equipment is not installed in accordance with the installation instructions and the governing body regulations, Climate Technologies reserves the right to refuse service on non-compliant installations.

Subject to state regulations and by law, a certificate of compliance must be issued for the electrical and plumbing works certifying that the work complies with all the relevant standards.

NOTE: Only a registered person will have insurance protecting their workmanship.

MODEL & SERIAL NUMBER

Your appliance model number, serial number and model description are located on the appliance data plate on the end of the heater, inside the Evaporative Cooler in the vicinity of the electronic controls, or on the Dual Cycle Outdoor Unit end panel and the Indoor Unit end panel. These details should also be in the warranty section of this booklet.

You will need this information, should your appliance require servicing, spare parts or if you require additional information about this product.

LIMITATIONS

The Navigator Controller does not support systems that have both Evaporative Cooler and Dual Cycle Refrigerated Cooler units together.

WARRANTY

Warranty service work must only be carried out by Climate Technologies service division or its authorised service providers. Please refer to the warranty section.

SAFETY

These appliances are not intended for use by persons (including children) with reduced physical, sensory or mental capacities, lack of experience and knowledge, unless they have been given supervision or instruction concerning use of the appliance by a person responsible for their safety. Children should be supervised to ensure that they do not play with these appliances.

Text and Illustration Copyright Climate Technologies 2011

All rights reserved. No part of this document may be reproduced or transmitted in any form or by any means, electronic or mechanical, including photocopying, recording or by any information storage and retrieval system, without prior permission in writing from Climate Technologies

In the interest of continued product improvement Climate Technologies reserves the right to alter specifications without notice. E.&O.E.

Navigating the Controls



3. TYPES OF NAVIGATOR CONTROLLER

Use these pictures to identify which model you have.

WALL MOUNTED CONTROL

This model is mounted permanently in the cradle on your wall. No batteries are required. Power is supplied via the same cable that takes the controller's signals to your heating and / or cooling appliances.

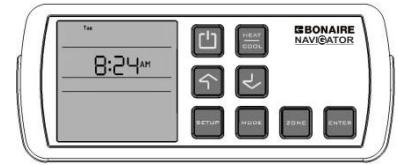

REMOTE CONTROL

This model is hand held and will operate your appliances from most areas of your home – See **IMPORTANT NOTE** for exceptions.

The remote Navigator Controller (wireless) is powered by 3 AAA batteries. The battery icon indicates the battery strength. The wave icon indicates transmission of a communication to your appliance.

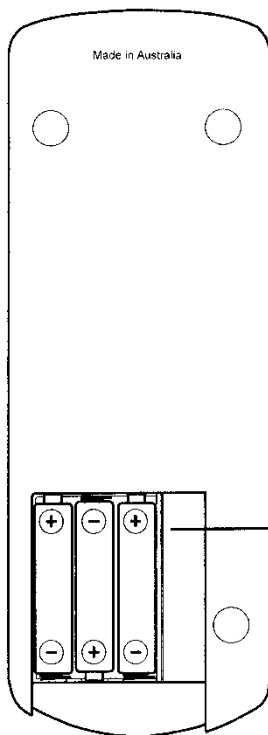
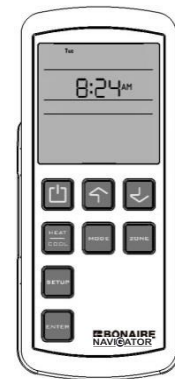

Batteries (Hand Held RF only)
Three alkaline AAA size 1.5V batteries are required. Do not mix old and new batteries.

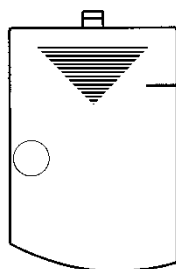

Battery Door
Slide open door allow batteries To be easily installed without the Need for a tool

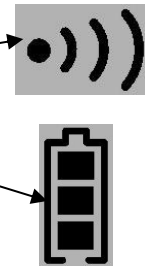

IMPORTANT NOTE

To reduce the risk of possible RF interference, do not locate your remote control near any electrical equipment e.g. TVs, computers, fridges, telecommunications and HI FI equipment or close to metal objects or window frames.

Some other wireless devices around your home may occasionally cause interference (such as wireless door bells, gates & door openers, or baby monitors & intercoms). Such interference can impede the operation of your appliance.

Ensure the remote control unit is not exposed to excessive heat, humidity, moisture or dampness.

Navigating the Controls



4. FEATURES OF THE NAVIGATOR CONTROLLER

1. TEMPERATURE SENSOR

The temperature sensor measures the room temperature for thermostatic operation (REMOTE SHOWN).

2. LCD DISPLAY

This displays the operational status of the control - appliance mode, time, day, room temperature, set temperature, comfort level, fan speed, batteries and programming.

3. SOFT TOUCH BUTTONS

8 button layout

4. NAVIGATOR CONTROL CRADLE

- Fixed to the wall, this permanently mounts the wired Navigator wall control.
- Fixed to the wall for easy access to the wireless remote control.

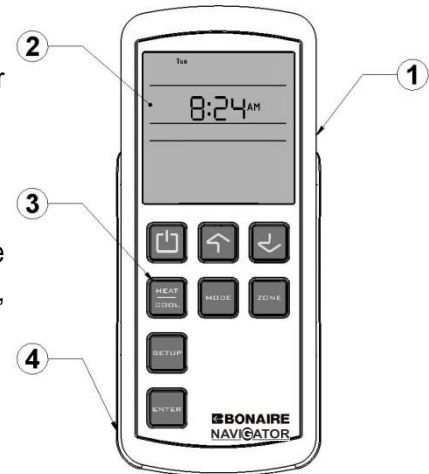

OTHER FEATURES

- Time and day: The user can set the Time Format, Hours, Minutes and Day.
- Zone control: The Navigator Controller allows you to control zone dampers if installed. Zone motors are not supplied by Climate Technologies P/L.
- Child Lock: The user can protect the Navigator Control program settings.
- Programmed operation: The Navigator Controller can program the appliances by day or week (heating and dual cycle).
- Home automation compatibility
- Control of multiple appliances: Your Navigator Controller is designed to operate multiple appliances.
- Error reporting: Your Navigator Controller will report any errors or faults.
- Installer system setup procedure
- Service, diagnostic and error log modes
- Multiple control options
- Additional features for Pinnacle evaporative cooler units



Navigating the Controls

5. USING THE 8 BUTTONS

The following explains the function of each of the buttons:-

ON/OFF BUTTON

- Turns your heating and / or cooling appliances ON and OFF.

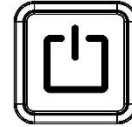

↕ ↘ BUTTONS

- Press & hold the **UP/DOWN** button to increase or decrease settings
- Or press & release the **UP/DOWN** button to increase or decrease one point at a time. Settings include day, time, temperature, fan speed.
- The **UP/DOWN** buttons are also used to select the different zones or programs available.

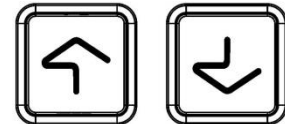

HEAT/COOL BUTTON

- Press to select from the heating and or cooling choices available. (In most cases you will only be able to see the names of the appliances that you have installed. If there is only one appliance installed, pressing the heat/cool button will result in "Error" being displayed).
- **Heat:** Ducted Gas Central Heaters
- **Cool:** Evaporative or Dual Cycle Refrigerative Air Conditioning
- **Heat/Cool:** Ducted Gas Central Heater and Dual cycle Refrigerated Air Conditioning

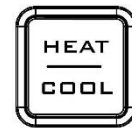

MODE BUTTON

- The MODE button allows the user to select the operating mode for the currently selected appliance type.
- There are six modes of operation defined. Thermo and Fan are common to all appliances. Program, Manual, Boost and Economy are only available on certain appliance types.
- Also for **Pinnacle evaporative cooler** units (only) press & hold Mode button functions – humidity control (if handset is in the ON state) & exhaust function (if handset is in off state)

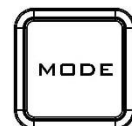

Program Thermo Manual Fan Boost Economy



Navigating the Controls

ZONE BUTTON

- The ZONE button allows the user to select the area or section of your house for heating and cooling control (if zones are available).



SETUP BUTTON

- The SETUP button is used to configure the Navigator Controller in either the ON or OFF condition. It allows time setting, programming and advanced setup. The advanced setup will only be enabled if the Navigator Controller is in the OFF condition.



ENTER BUTTON

- Press and release the ENTER button to save settings when in SET TIME, PROGRAM mode and ZONE setting.
- Press and release the ENTER button to immediately send instructions.



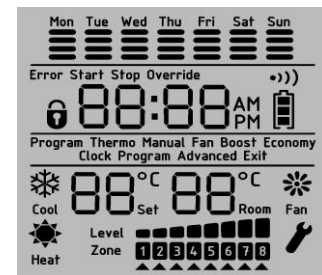

6. THE LCD DISPLAY

The Navigator Controller LCD display shows different information depending on the functions in use. The Navigator Controller usually shows only those items relevant to the appliances you have installed.



7. BACKLIGHT

The Navigator Controller provides a **BLUE** and **ORANGE** backlight. The blue backlight is illuminated for cooling appliances and the orange backlight is illuminated for heating appliances. To adjust the backlight brightness level,

- Press and hold the **SETUP** button until "LitE" appears on the display.
- Press the  or  button to decrease or increase the backlight level.
- Press the **ENTER** button to save the new backlight level selection.

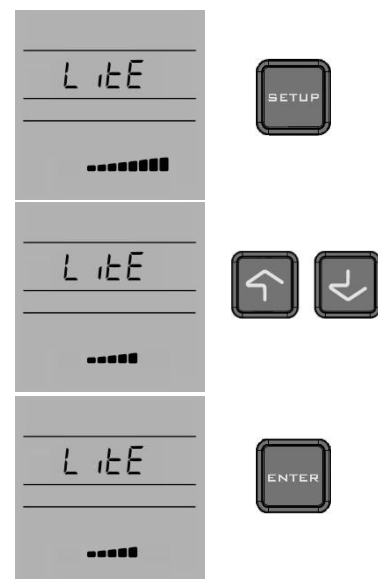

8. REMOTE TRANSMISSION

To give you time to choose your settings, the remote Navigator Controller pauses 15 seconds and then sends its signal to your Heater/Cooler. Watch for the transmit symbol  on the screen. This means that the signal has been sent. (Wireless remote only).

Navigating the Controls



Your Navigator Controller is designed to automatically detect the appliances connected. Controller options not required for your connected appliances will be hidden and not displayed on your Navigator Controller, therefore some menu items shown in this instruction may not appear.

9. SETTING THE DAY AND TIME

On first power up or after a reset, the time display will flash 12:00 am until the user sets the time or it receives a set time command from another device. The user can set the time with the controller in an ON or OFF state.

To set the time,

1. Press the **SETUP** button and it will display the Clock, Program and Advanced (OFF state only) icons on the display. The Clock icon will be flashing.
2. Press the **ENTER** button to select the clock and it will display the time format **12: h** or **24: h**. To select the time format, press the **UP/DOWN** button and then press the **ENTER** button to save.
3. The display will then flash the HOURS. Press the **UP/DOWN** button to increase or decrease the hours. Press the **ENTER** button to set the hours.
4. The display will then flash the MINUTES. Press the **UP/DOWN** button to increase or decrease the minutes. Press the **ENTER** button to set the minutes.
5. The display will flash the DAY on the top row of the display. Press the **UP/DOWN** button to change the day. Press the **ENTER** button to select the day.
6. The Navigator Controller will now display the Clock, Program and Advanced icons again. Press the **ON/OFF** button (OFF state) or the **SETUP** (ON state) button to go to the main display.

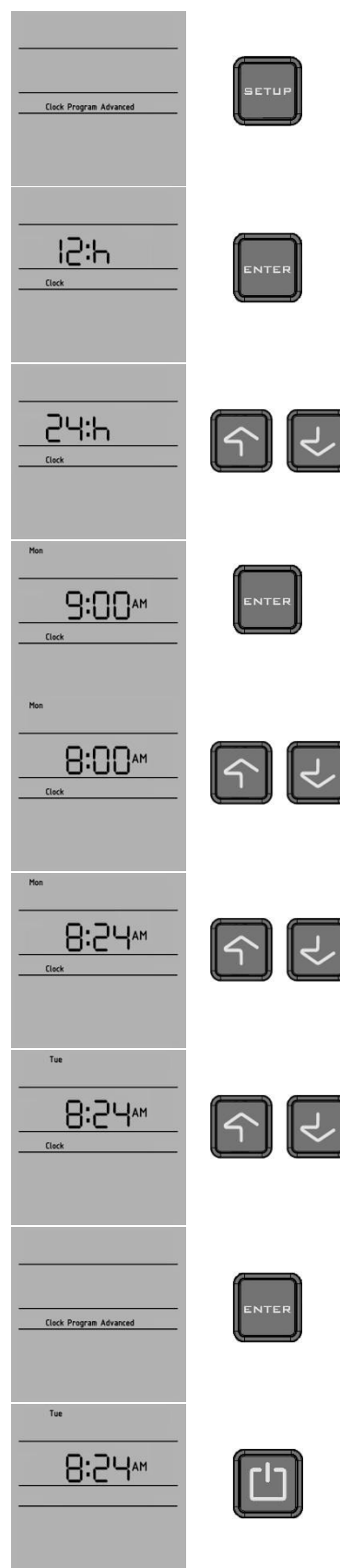

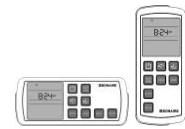



Navigating the Controls

10. SIMPLE MANUAL OPERATION (Heating or Cooling)

Here's all you have to do to get the system going (if the installer hasn't already done it for you).

1. Turn the Navigator Controller ON by pressing the **ON/OFF** button.
2. Press the **HEAT/COOL** button to select the appliance (if more than one appliance is connected).
3. Press the **MODE** button to select different modes of operation.
4. Press the  or  buttons to set the temperature, fan speed or comfort setting.

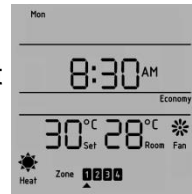

Your unit will now operate as required.

**NOTE: When the back light is blue, it is in cooling mode.
When the back light is orange, it is in heating mode.**





11. APPLIANCE TYPE SELECTION

Your Navigator Controller can operate multiple appliances (where more than one type of appliance has been connected). You can select the appliance type by pressing the HEAT/COOL button. You will see the Heat, Cool or Heat/Cool icons on the display of the Navigator Controller.

NOTE: Heat/Cool is only allowed on installations with a heater and Dual Cycle Refrigerative cooling.

 **Heat** Icon indicates that your appliance is in heating mode.

 **Cool** Icon indicates that your appliance is in cooling mode.

 **Cool**
 **Heat** Icon indicates that your appliance is in heating and cooling mode.

To select different appliances,

1. Turn the Navigator Controller ON by pressing the **ON/OFF** button.
2. Press the **HEAT/COOL** button to operate the different appliances if more than one appliance is connected.
3. Press the **ENTER** button to select your desired appliance type.

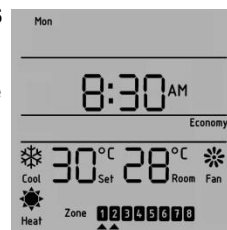
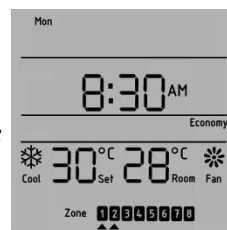
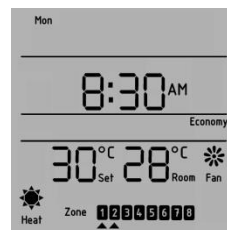

Navigating the Controls



12. CHILD LOCK

Your Navigator Controller provides a special child lock function to protect the current operation or program. To activate the **CHILD LOCK** function at any time,

1. Press and hold the **HEAT/COOL** and **MODE** buttons.
2. The child lock is enabled and the lock icon  will appear on the display. Any key press will be ignored and the error icon will flash.
3. Press and hold the **HEAT/COOL** and **MODE** buttons again to disable the child lock.

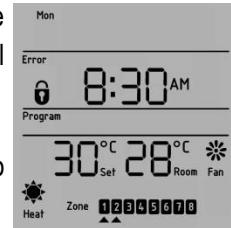



Ducted Gas Central Heating

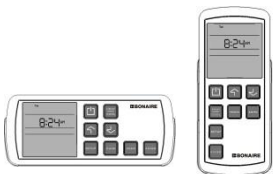
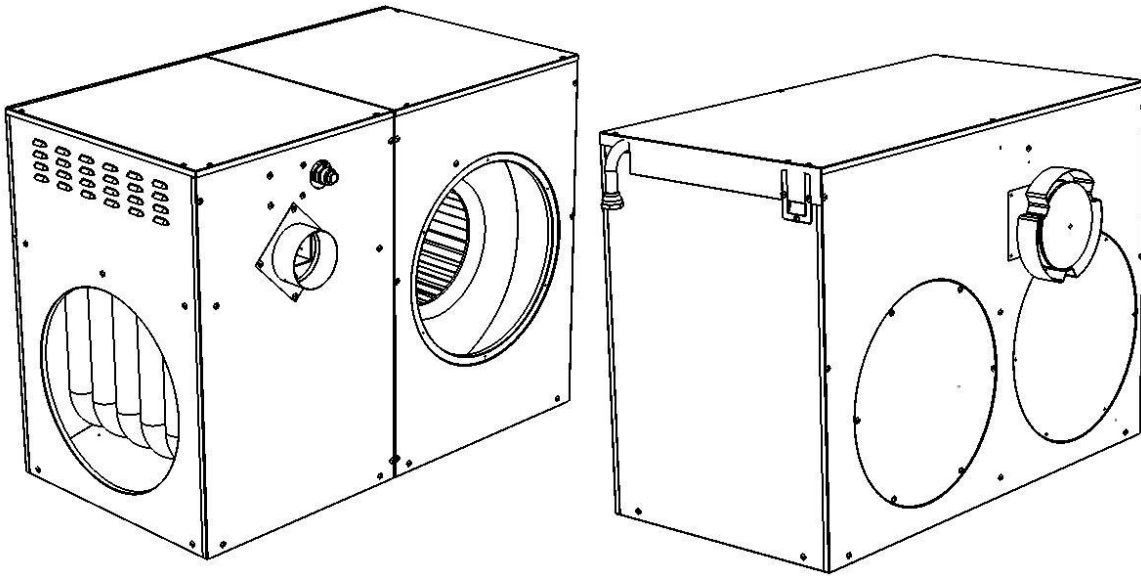

Owner's Operation and Maintenance Instructions

Please keep this important manual in a safe place. It is the owner's responsibility to ensure that regular maintenance is carried out on the Ducted Gas Central Heater. Failure to do so will void all guarantees beyond statutory and legal requirements.

Ducted Gas Central Heating



Congratulations on purchasing a BONAIRE Ducted Gas Central Heating system, an exciting new product manufactured by Climate Technologies.

Wholly designed and manufactured in Australia, BONAIRE Ducted Gas Central Heaters represent an exciting new development in warm air furnace design. It embodies the latest advances in gas heating technology.

Your heater is supported by Climate Technologies, Australia's most advanced manufacturer of a complete range of climate control products.

To ensure you fully enjoy the benefits of your BONAIRE Ducted Gas Central Heater, please read these instructions carefully and keep them handy for future reference.

If operated and maintained in accordance with this manual, your BONAIRE unit will provide you with years of warm and environmentally friendly operation. Please take the time to read this manual.

13. GENERAL INFORMATION



IMPORTANT NOTICE

A licensed person is required to install any Heating/Cooling equipment. If the equipment is not installed in accordance with the installation instructions and the governing body regulations, Climate Technologies reserves the right to refuse service on non-compliant installations.

Subject to state regulations and laws a certificate of compliance must be issued for the electrical and plumbing work certifying that the work complies with all the relevant standards.

Note: Only a registered person will have insurance protecting their workmanship.

MODEL & SERIAL NUMBER

Your appliance model number, serial number and model description are located on the appliance data plate on the end of the heater or under the lid in the vicinity of the electronic controls. These details should also be in the warranty section of this booklet.

You will need the model & serial number, should your appliance require servicing, spare parts or if you require additional information about this product.

ASSEMBLY

There is no assembly required of this Ducted Gas Central Heater. Your Dealer or installer will carry out all assembly and commissioning upon installation.

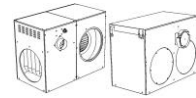

Ducted Gas Central Heating

14. SAFETY

SAFETY & OWNER RESPONSIBILITY

The manufacturer and its service providers reserve the right to refuse service unless safety and accessibility to the unit can be guaranteed in accordance with the installation instructions and Australian Standards. The cost of any extra equipment required to provide access to the unit for servicing is the responsibility of the owner.

This appliance is not intended for use by young children or infirm persons unless they have been adequately supervised by a responsible person to ensure that they can use the appliance safely.

Young children should be supervised to ensure that they do not play with the appliance.

PRECAUTIONS

DO NOT PLACE ARTICLES ON OR AGAINST THIS APPLIANCE.

DO NOT USE OR STORE FLAMMABLE MATERIALS NEAR THIS APPLIANCE.

DO NOT SPRAY AEROSOLS IN THE VICINITY OF THIS APPLIANCE WHILE IT IS IN OPERATION.

DO NOT PLACE ARTICLES IN FRONT OF OR OVER THE RETURN AIR GRILLE.

NOTE: If the supply cord is damaged, it must be replaced by the manufacturer, its service agent or similarly qualified persons in order to avoid a hazard.

FEATURES

Your BONAIRE Ducted Gas Central Heater includes all the safety devices required to ensure safe operation. These devices conform to the standards set out by Standards Australia.

POWER OR GAS INTERRUPTION

Should there be an interruption to the power supply during heating operation, the controls will automatically turn off the gas.

NOTE: If there is an interruption to the power supply, the Navigator Controller will remember all settings and programs for 30 minutes. After 30 minutes without power, the Navigator Controller will revert to the default settings. (This also applies to the remote when the batteries are removed).

Depending on the unit installed, the product may not restart when power is resumed. In these cases it will be necessary to manually reset the controller.

Should there be an interruption to the gas supply, the heater will endeavor to re-light and if unsuccessful it will lock out. (This is part of the safety features). Should this occur the heater will need to be reset.

Please refer to your problem-solving chart to assist in resolving other problems.

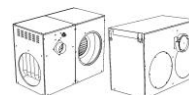

Ducted Gas Central Heating

15. USING YOUR NAVIGATOR CONTROLLER

There are 2 ways to operate your Navigator Controller. You can select MANUAL CONTROL and choose the mode of operation or you can set a PROGRAM for automatic operation.

NOTE: If there is only a central heater fitted in the house, the Navigator Controller will default to Heat. Your Navigator Controller is programmed to automatically detect the appliances connected. Controller options not required for your connected appliances will be hidden and not displayed on your Navigator Controller, therefore some menu items shown in this instruction may not appear.



MANUAL CONTROL

In manual control you can operate in thermo, economy, boost or fan mode and operate zones.

THERMO MODE

In Thermo mode the Heater will operate as set to achieve the desired comfort set temperature.

To use the Thermo mode -

1. Turn the Navigator Controller ON by pressing the **ON/OFF** button.
2. Press the **MODE** button until the Thermo icon appears on the display and press the **ENTER** button to select.
3. Press the  or  buttons to decrease or increase the set temperature. You can set the temperature from 10°C to 32°C. For efficient operation, set the temperature around 20°C to 21°C. Temperatures set over this could result in high energy bills as your appliance may not be operating at optimum efficiency.
4. The Navigator Controller measures the room temperature using a thermostat inside its case. When the room temperature is colder than the set temperature, the heater will come on (after a 30 second ignition process).

NOTE: Do not leave the wireless Remote Navigator controller where air from a heater outlet or other heat & cold sources impact on it as it may affect the thermostat operation.

5. The Navigator Controller will run the heater until it determines that the room temperature has reached your set temperature. The controller will then turn off the heater until the temperature falls below the set temperature before restarting.
6. For MB4 and MB5 star heaters, the operation of the heater is as follows:
 - If at start up, the room temperature is more than 2.0° below the set temperature, the central heater will start up at high fan speed and high gas rate, quickly bringing your house up to temperature.



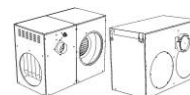

Ducted Gas Central Heating



- As the room temperature gets closer to the set temperature the central heater will reduce the room air fan and the gas rate to the burner.
- When the room temperature reaches the set temperature, the central heater will shut down and when the room temperature has dropped below the set temperature, the unit will restart.
- As your activities vary, you may find you need different temperature settings, e.g. a temperature comfortable for sitting is sometimes too warm compared to when you're moving about.
- For economical operation, set a low set temperature during the day when you are active, or use the ECONOMY mode. Switch the Navigator Controller OFF when asleep and ON again when awake. These cost saving functions can be programmed to operate automatically (see Programmed Control).

The Navigator Controller remembers your set temperature setting and uses it next time you turn it ON.

ECONOMY MODE

The Economy mode operates the heater at the lowest power level if the room temperature is below the set temperature. The Navigator Controller turns off the unit when the set temperature is reached and back on when the room temperature drops again.

To operate the Economy mode -

1. Turn the Navigator Controller ON by pressing the **ON/OFF** button.
2. Press the **MODE** button until the Economy icon appears on the display and press the **ENTER** button to select.
3. Press the  or  buttons to decrease or increase the set temperature. For efficient operation, set the temperature around 20°C to 21°C. Temperatures set over this could result in high energy bills as your appliance will not be operating at optimum efficiency.

For most efficient operation, it is recommended that the economy mode is used after the home comes up to temperature.



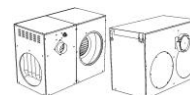

Ducted Gas Central Heating

BOOST MODE

The Boost mode operates the heater at maximum power level if the room temperature is below the set temperature. The Navigator Controller turns off the unit when the set temperature is reached. The Navigator Controller turns the unit back on when the room temperature drops again. To operate Boost mode -

1. Turn the Navigator Controller ON by pressing the **ON/OFF** button.
2. Press the **MODE** button until the Boost icon appears on the display and press the **ENTER** button to select.
3. Press the **UP/DOWN** button to decrease or increase the set temperature. For efficient operation, set the temperature around 20°C to 21°C. Temperatures set over this could result in high energy bills as your appliance will not be operating at optimum efficiency.



FAN MODE

In Fan mode the heater operates the fan only, to circulate air. Fan speed in this mode can be adjusted to the desired level. To operate the FAN mode -

1. Turn the Navigator Controller ON by pressing the **ON/OFF** button.
2. Press the **MODE** button until the Fan icon appears on the display and press the **ENTER** button to select.
3. Press the **UP/DOWN** button to decrease or increase the fan speed. You can set the fan speed up to 8 levels. The room air fan will now run.



ZONING (IF INSTALLED)

Zoning is an option available on the 4 and 5 star central heaters (not available on 3 star units). The Navigator Controller is capable of controlling up to 8 switched zones and one unswitched zone. (The 4 and 5 star central heaters can operate 4 zones as standard. If more zone control is required, then a zone extension kit is available. This will increase zone control from 4 to 8 zones with one unswitched zone). Selecting ZONE only applies if your home is fitted with optional motorised ductwork dampers (please consult your installer) that allow opening or closing of each section of ducting.

The Navigator Controller will show only installed zones. If no dampers are fitted, no zones will be shown and zone setup can not be selected.

In homes with more than one zone, at least one zone must be open at all times. The default zone is 1 if no other is selected.



To open or close a ZONE: -

1. Press and release the **ZONE** button. ZONE 1 (or the current open zone) will flash.

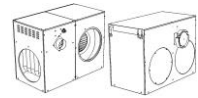



Ducted Gas Central Heating

2. Press the  or  button to select the zone you wish to control.
3. Press the **ZONE** button to toggle a zone open or closed. Repeat to open or close more zones. The arrows under the selected zones on the display indicate which zones are set to open / on.
4. Press the **ENTER** button to exit the Zone setup.

Now the Heater operates only in your selected zones.

PROGRAM MODE

To operate Program mode -

1. Turn the Navigator Controller ON by pressing the **ON/OFF** button.
2. Press the **MODE** button until the Program icon appears on the display & press the **ENTER** button to select.



PROGRAMMING YOUR NAVIGATOR CONTROLLER





Programming your Navigator Controller will provide energy and time savings. Your heating and/or cooling system will only operate when you need it, and at your chosen comfort levels. Determine your most comfortable settings, program them and let your Navigator Controller do the rest automatically.

PROGRAMMING SEQUENCE

Heater / Dual Cycle Refrigerated Air Conditioning

If you've never programmed your Navigator Controller before (or it's been a while) remember it's easiest to program the whole week to the same settings (by selecting the whole week MON TUE WED THU FRI SAT SUN day choice) and then program variations for particular days or the weekend as you become more familiar with programming.

If the Controller exits the program mode, it may be because you've paused longer than about 1 minute to make your next choice. All the settings you've made up to then will be saved. Just switch back to program mode, scroll through your settings using the **ENTER** button and carry on from where you left off. The following is the programming sequence for the Navigator Controller -

1. Press the **SETUP** button and it will display Clock, Program and Advanced (OFF state only) icons on the screen. Currently the Clock icon will be flashing.
2. Press the  or  button to select Program and press **ENTER**.
3. Press the  or  button to change the day or day group to be modified (Single Day, Week Days, Weekend or Whole Week). Press the **ENTER** button to complete the selection.

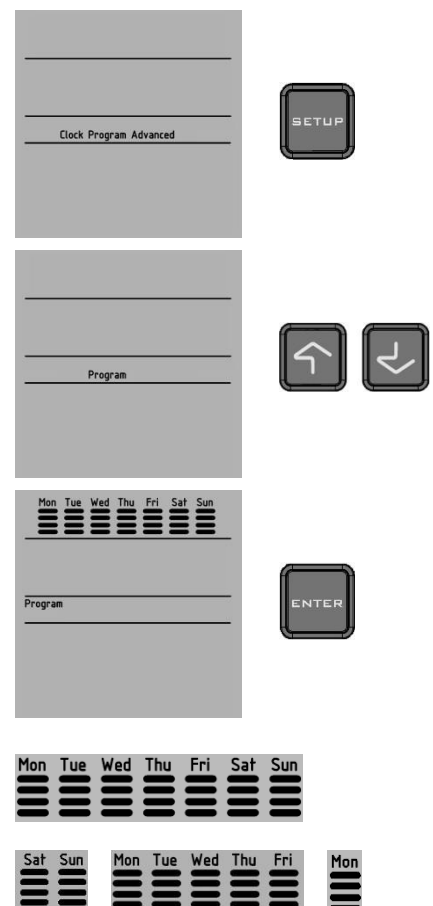



Ducted Gas Central Heating

4. You can set 4 program periods in one single day or day group. To select the program periods, press the or button and press the **ENTER** button. (**NOTE: Set these program periods in time sequence**).
5. The HOURS icon will now be flashing. To set the desired hour, press the or button and press the **ENTER** button to proceed. The MINUTES icon will now flash. Using the or button, set the minutes. Press the **ENTER** button to proceed.
NOTE: If you want to disable a period, set time to "--:--".
6. The temperature will now be flashing. To set the desired temperature, press the or button and then press the **ENTER** button. You can set the temperature from 10°C to 32°C.
NOTE: If you want set an off period, set temperature to "--".
7. ZONE will flash at bottom of the display (if switched zones are installed). ZONE 1 or the current zone will flash.
8. Press the or button to select the different zones. Press the **ZONE** button to open/close the selected ZONE and an arrow will appear under the selected zone.
9. Press the **ENTER** button to finish. The Navigator Controller will display and perform a **"Sort"** function. After the sorting function, the Navigator Controller will display the next period.
10. Press the **SETUP** button to go to the main screen.

If you want to make corrections to what you've entered, press the **SETUP** button and select program by pressing the or button. Now press the **ENTER** button and you'll start the programming sequence again. Scroll through the program selections by pressing the **ENTER** button and change any items as you come to them.

If the unit is running under the Program mode, the user may temporarily override the programmed settings by setting the temperature and the zone. In this case, an **"Override"** icon will appear on the display until the standard programming is resumed (by pressing **SETUP** to go back to the program).

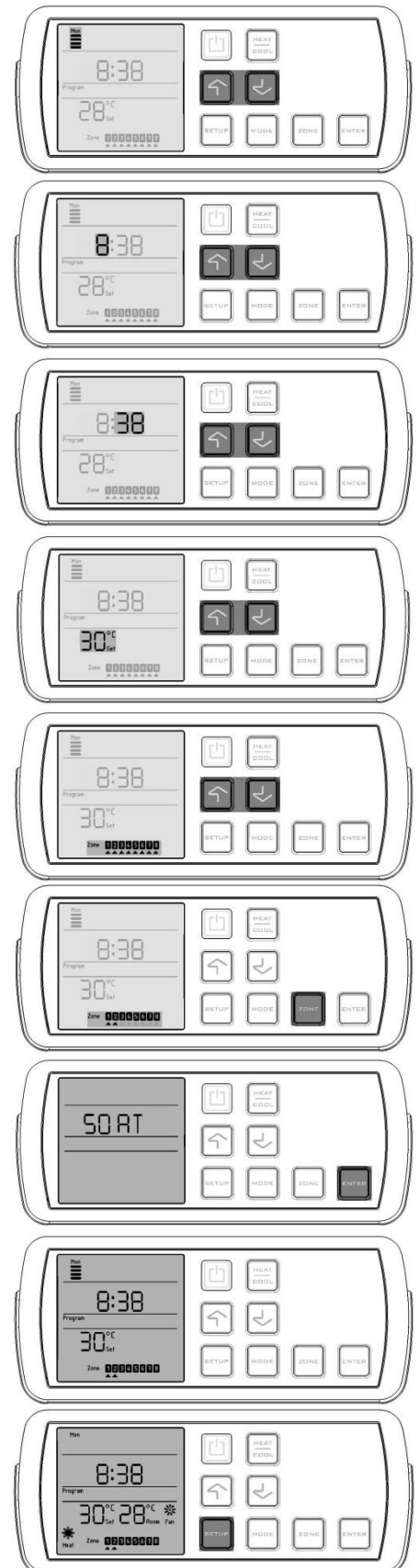

Ducted Gas Central Heating



16. HEATER MAINTENANCE

⚠ WARNING: *Before commencing any maintenance work on your unit, isolate the power at the supply (Switch Board).*

NOTE: *It is essential that your central heater be maintained in accordance with this manual. Failure to do so will affect the life of the product and reduce the level of efficiency.*

ELECTRICAL

No general maintenance is required to the electrical system.

Only a Qualified Electrician should carry out electrical connections and maintenance.

RETURN AIR GRILLE FILTER

If your heating system has a filter in the return air grille, it is extremely important that it is cleaned every 3 – 4 weeks during the operating period to ensure correct operation of the heating unit. Failure to do so may cause your heater to stop because of over temperature and cause an unnecessary service call (not covered by warranty).

FLUE

The flue and cowl assembly should be clean and free of obstructions.

17. SCHEDULED MAINTENANCE

Your BONAIRE Ducted Gas Central Heater should be serviced annually to ensure trouble free operation.

1. To ensure that your heater continues to operate at peak efficiency and safety, your appliance must be periodically serviced by a qualified and licensed service technician.
2. Gas pressures, the gas system & connections, the flue and connections, the drain and connections (MB5), fan blades, motors, ignition systems and burners should be checked every year. The heater cabinet and immediate surroundings should be kept clean.
3. Replace the batteries in the remote Navigator Controller at the start of each heating season with new AAA alkaline batteries.

OTHER ITEMS

There are other items your Climate Technologies service technician will attend to for scheduled maintenance.

Service Call: Service contact details are located on page 39 of this manual.



Ducted Gas Central Heating

18. PROBLEM SOLVING

WHAT IF THE CENTRAL HEATER WILL NOT OPERATE?

	Question	Y/N	Solution
1.	Has the unit been run since installation?	Yes	Refer to question 4
		No	Check the unit is turned on at the power point and the gas shut off valve is turned on. If not, call the installer to commission the unit.
2.	Is the unit installed in a new home?	Yes	Refer to question 3
		No	Refer to question 4
3.	Has the installer run the unit?	Yes	Refer to question 4
		No	Check the unit is turned on at the power point and the gas shut off valve is turned on. If not, call the installer to commission the unit.
4.	Is the set temperature greater than the room temperature?	Yes	Turn the unit off (for more than 2 seconds) and then on to reset the unit. If the unit still does not start, call for service. (refer to solution 6 for reset instructions)
		No	Increase the set temperature so the thermostat calls for heat.
5.	Is the thermostat in program mode?	Yes	The heater may be programmed to be OFF. To operate the heater manually, press the MODE button until Thermo is displayed. Adjust the room temperature to be greater than the set temperature.
		No	Adjust the room temperature to be greater than the set temperature.
6.	Has there been a known power surge?	Yes	Reset the unit - 1. Turn the power OFF then ON at the power point 2. Turn the control to OFF 3. Pressing the reset button on the circuit control board
		No	Unit should operate normally. If not, a service call will be required.

**THIS TROUBLE SHOOTING GUIDE IS A REFERENCE ONLY.
 FOR SERVICE OR WARRANTY REQUIREMENTS PLEASE REFER TO
 THE WARRANTY SECTION OF THIS BOOK**

Dual Cycle Refrigerated Air Conditioning

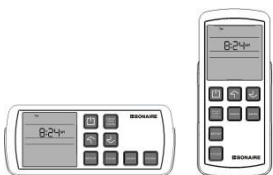
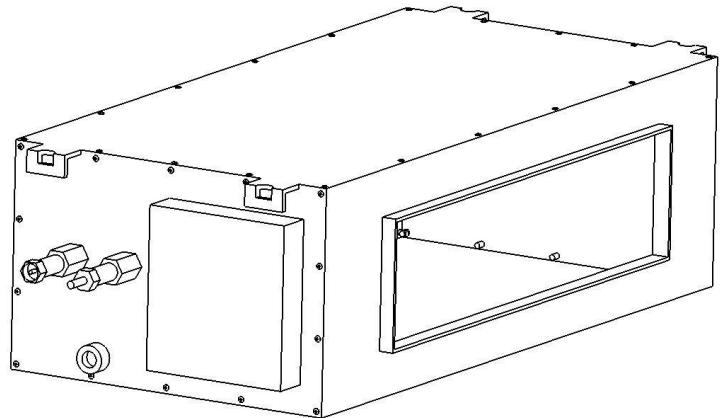
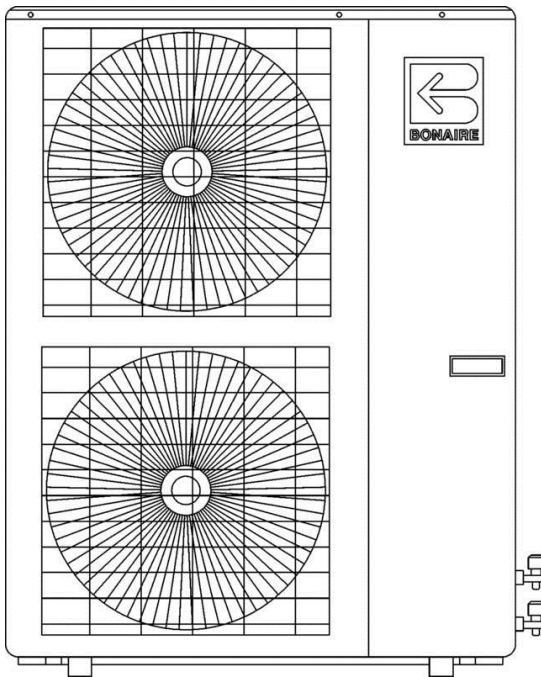
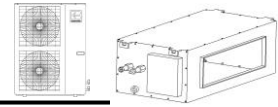

Owner's Operating and Maintenance Instructions

Please keep this important manual in a safe place. It is the owner's responsibility to ensure that regular maintenance is carried out on this Dual Cycle Ducted Gas Central Heater / Refrigerated Air Conditioner. Failure to do so will void all guarantees beyond statutory and legal requirements.

Dual Cycle Refrigerated Air Conditioning

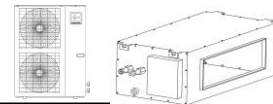

19. GENERAL INFORMATION

IMPORTANT NOTICE

If an appropriately qualified and licensed person is not used to install the equipment or if it's not installed according to the guidelines, then Climate Technologies will not accept responsibility for any problems which occur as a result.

MODEL & SERIAL NUMBER

Your appliance model number, serial number and model description are located on the appliance data plate on the access panel of the outdoor unit. These details should also be in the warranty section of this booklet.

You will need this information, should your appliance require servicing, spare parts or if you require additional information about this product.

ASSEMBLY

There is no assembly required for this Dual Cycle Refrigerated Air Conditioning + Gas Central Heating System. Your Dealer or installer will carry out all assembly and commissioning upon installation.

20. SAFETY

SAFETY & OWNER RESPONSIBILITY

The manufacturer and its service providers reserve the right to refuse service unless safety and accessibility to the unit can be guaranteed. The cost of any extra equipment required to provide access to the unit for servicing is the responsibility of the owner.

This appliance is not intended for use by young children or infirm persons unless they have been adequately supervised by a responsible person to ensure that they can use the appliance safely.

Young children should be supervised to ensure that they do not play with the appliance.

PRECAUTIONS

DO NOT PLACE ARTICLES ON OR AGAINST THE CONDENSER/OUTDOOR UNIT.

DO NOT PLACE ARTICLES IN FRONT OF THE CONDENSER/OUTDOOR UNIT.

ENSURE THE CLEARANCES BETWEEN THE UNIT AND WALLS/OBSTRUCTIONS ARE KEPT CLEAR.

DO NOT PLACE ARTICLES IN FRONT OF OR OVER THE RETURN AIR GRILLE.

FEATURES

Your Ducted Gas Central Heater and Dual Cycle Refrigerated air conditioner have all the safety devices required to ensure safe operation. These devices conform to the standards set out by Standards Australia.

POWER INTERRUPTION

Should there be an interruption to the power supply during the cooling operation the controls will automatically shut down.

NOTE: If there is an interruption to the power supply, the Navigator Controller will remember all settings and programs for 30 minutes. After 30 minutes without power, the Navigator Controller will revert to the default settings. (This also applies to the remote when the batteries are removed).

Your gas ducted heater and/or Dual Cycle cooler will automatically resume operation once the power has been restored.

Dual Cycle Refrigerated Air Conditioning

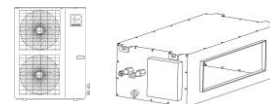



21. USING YOUR NAVIGATOR CONTROLLER

Using your Navigator Controller with your Dual Cycle Refrigerated Air Conditioner is the same as your gas central heater where you want direct manual control, without programming. When you press the HEAT/COOL button, your Navigator Controller will display 3 options - Cool, Heat, or Heat & Cool.

COOLING

In the cool option there are 3 modes of operation - Program, Thermo and Fan. For cooling -

1. Turn the Navigator Controller ON by pressing the **ON/OFF** button.
2. Press the **HEAT/COOL** button until the Cool icon appears on the left side of the display and press the **ENTER** button to select.
3. Press the **MODE** button to change the mode of operation. Press the **ENTER** button to select the mode.
4. Press the  or  button to decrease or increase the

temperature and press the **ENTER** button to set the temperature. You can set the temperature from 10°C to 32°C. For efficient operation, the set temperature should be around 22°C to 25°C. Temperatures set below this could result in high energy bills as your appliance may not be operating at optimum efficiency.

5. Press the **ZONE** button to operate the different available zones.

HEATING

- The heat option is the same as the Ducted Gas Heating. In this state the system has 5 modes of operation - Program, Thermo, Boost, Economy and Fan.
- Please refer to the MANUAL OPERATION of the Ducted Gas Central Heating.

HEAT & COOL

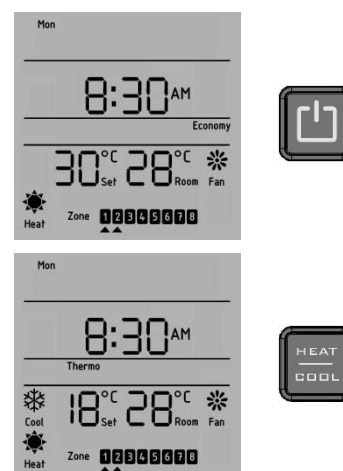

In the Heat & Cool state the system has 3 modes of operation - Program, Thermo and Fan. To turn the Heat & Cool state on -

1. Turn the Navigator Controller ON by pressing the **ON/OFF** button.
2. Press the **HEAT/COOL** button until both the Heat & Cool icons appear on the display and press the **ENTER** button to select.
3. Press the **MODE** button to operate the different modes of operation and press the **ENTER** button to select.

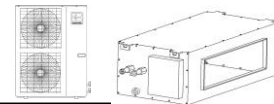



Dual Cycle Refrigerated Air Conditioning

4. Press the  or  button to decrease or increase set temperature. You can set the temperature from 10 to 32 degrees.
5. The Navigator Controller measures the room temperature using a thermostat inside it's case. When the room temperature is warmer than the set temperature, the Dual Cycle Refrigerated Cooling unit will cycle on. When the room temperature is cooler than the set temperature, the heater will be turned on.
6. Press the **ON/OFF** button to switch the appliances OFF.
7. The Navigator Controller remembers your set temperature setting and uses it next time you turn it ON.



ZONING

Selecting ZONES only applies if your home is fitted with optional motorised ductwork dampers (please consult your installer) that allow opening or closing of each section of ducting.

The Navigator Controller will not display any zones if dampers are not fitted and set up. Where dampers are fitted, the installer can set your controller to show only the zones available for use.

In homes with more than one zone, at least one zone must be open at all times. The default zone is 1 if no other is selected.

To open or close a ZONE:-

1. Press the **ZONE** button. ZONE 1 (or the current open zone) will flash
2. Press  or  to select the zone you wish to control.
3. Press the **ZONE** button to set a zone as open (ON) or closed (OFF). The arrow will appear under the selected zone if the zone is ON. Repeat to open or close more zones.

22. PROGRAMMING YOUR NAVIGATOR CONTROLLER

Programming your Navigator Controller will provide energy and time savings. Your heating/cooling system will only operate when you need it, and at your chosen comfort levels.

Determine your most comfortable settings, program them and let your Navigator Control do the rest automatically.

USING THE PROGRAMMING SEQUENCE

Refer to Ducted Gas Central Heating Section for **PROGRAM MODE** and **PROGRAMMING YOUR NAVIGATOR CONTROLLER**.

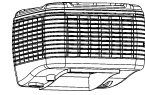

Ducted Evaporative Air Conditioning

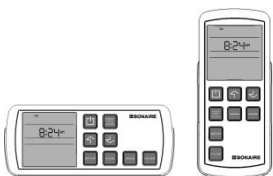
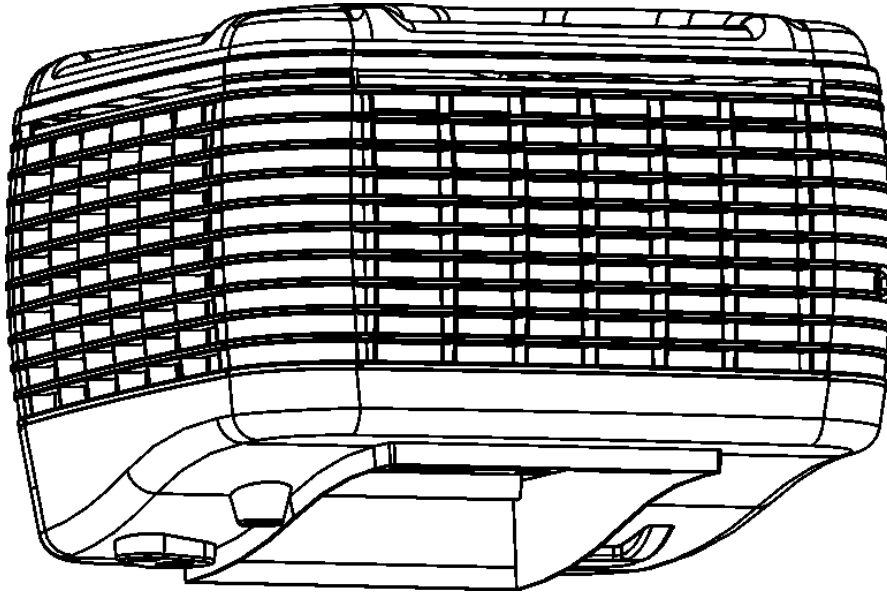

Owner's Operating and Maintenance Instructions

Please keep this important manual in a safe place. It is the owner's responsibility to ensure that regular maintenance is carried out on this Ducted Evaporative Air Conditioner. Failure to do so will void all guarantees beyond statutory and legal requirements.

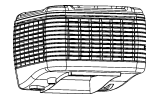

Ducted Evaporative Air Conditioning

23. INTRODUCTION

Your ducted evaporative air conditioner is engineered to meet the rigours of our harsh Australian environment. Operated and maintained in accordance with this manual, it will provide you with years of quiet, cool and environmentally friendly operation. Please take the time to read this manual.

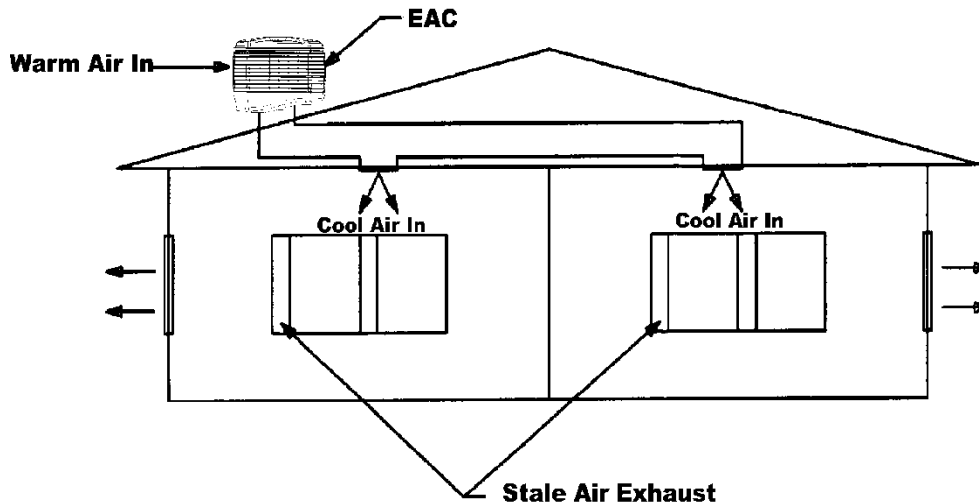

The principle of evaporative cooling is to supply fresh air which is washed through the filter pads to cool it. The cool fresh air circulates through the home, replacing warmer air.

GENERAL INFORMATION

If the appliance supply cord is damaged, it must be replaced by a special cord or assembly available from the manufacturer or it's service agent.

The unit is suitable for operation on mains water supply, water pressure min 100kPa, max 500kPa.

24. UNIT OPERATION

EXHAUST

It is essential for successful operation of evaporative air-conditioning that there are sufficient exhaust openings in the area to be ventilated. Open doors and windows will usually provide this.

The minimum exhaust opening should be as per the table guide set out below. It is recommended that ceiling vents or exhaust fans be used where there is any doubt about there being sufficient exhaust area available. Ceiling exhaust fans or ceiling vents should have a capacity equivalent to that of the Evaporative air conditioner.

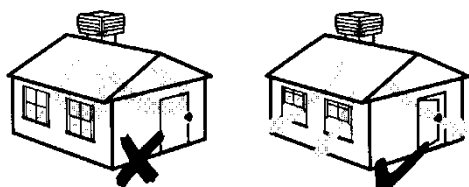

Vent Area for Doors and Windows

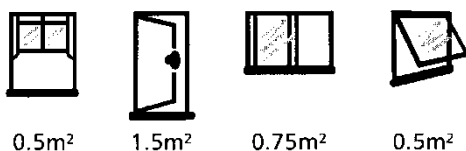

MODEL	MINIMUM EXHAUST AREA
Small	0.85 m ²
Medium	1.19 m ² to 1.48 m ²
Large	2.02 m ²

Ducted Evaporative Air Conditioning

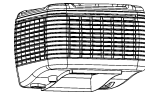

WATER MANAGEMENT

All evaporative air conditioners need some water to go to waste to prevent build-up of mineral deposits in the system. Your unit has been supplied with an Aquamiser as well as a bleed control system to provide maximum options for best water management.

The correct setting of the Aquamiser and bleed will ultimately govern the life of the unit. Should there be evidence of a build up of mineral deposits in the unit, check the draining intervals and/or bleed-off rate.

Failure to manage the correct levels of non dissolved solids in the unit will void warranty. Refer to your local dealer for best settings.

AQUAMISER

The Aquamiser operates as a drain valve. Whenever the fill valve is de-energised or energised, the aquamiser motor is driven open or closed.

Drain cycles will have to be activated and set in accordance with the water quality in your area. In areas of good water quality, the correct drain cycle only may suffice and the bleed-off function in the DIALFLO may not be required. Increased water hardness may require a bleed rate as well as a drain cycle and increased maintenance.

Drainage from the Aquamiser must be plumbed away in accordance with local and state plumbing requirements. However this water could also be stored in a non drinking water tank for other use.

SET THE WATER DISTRIBUTION FLOW RATE

To set the water distribution flow rate, locate the DIALFLO externally on one of the unit corner posts. Rotate the filter knob (the outer knob) anti-clockwise for more water and clockwise for less water. Do this before setting the bleed rate.

NOTE: *If the flow rate is set incorrectly, a lack of cooling may be experienced or damage to the unit/ house may occur. Call your Dealer/Installer.*

SET THE BLEED-OFF RATE

Use the DIALFLO to rotate the BLEED knob (the inner knob) clockwise for more water flow and anti clockwise for less.

Note: Hold the distribution knob (Filters) while setting the bleed rate as the distribution flow rate may go out of adjustment.

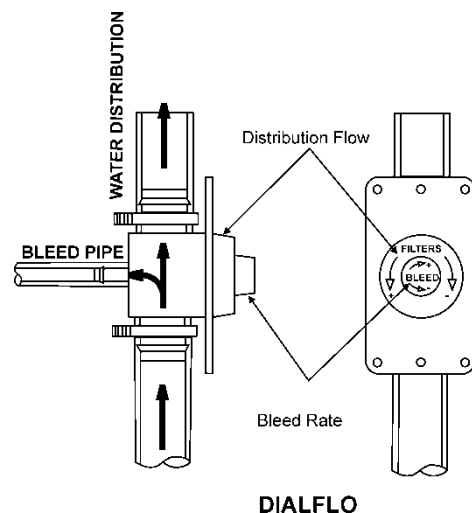
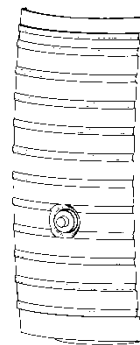
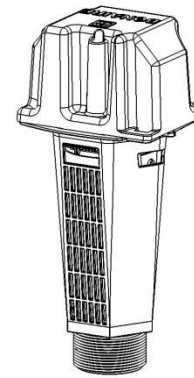

Ducted Evaporative Air Conditioning

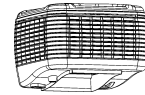



25. USING YOUR NAVIGATOR CONTROLLER

Your Navigator Controller will operate your ducted evaporative air conditioner in 4 modes - Manual, Thermo, Boost and Fan.



NOTE: Your Navigator Controller is designed to automatically detect the appliances you have installed. Controller options not required for your appliances will usually not be visible on your Navigator Controller display.

MANUAL MODE

1. Turn the Navigator Controller ON by pressing the **ON/OFF** button. If there is only an evaporative ducted air conditioner fitted, the Navigator Controller will display Cool icon.
2. Press the **MODE** button until the Manual icon appears on the display and press the **ENTER** button to select.
3. Press the  or  button to decrease or increase fan speed. Your Navigator Controller provides 7 levels operation.
4. To turn the unit OFF, press the **ON/OFF** button.

Note For Pump Only operation, when in manual mode, press the arrow down button to reach "0". "Pu nP on ly" will be displayed on the handset.

THERMO MODE

1. Turn the Navigator Controller ON by pressing the **ON/OFF** button. If there is only an evaporative ducted air conditioner fitted, the Navigator Control will display Cool icon.
2. Press the **MODE** button until the Thermo icon appears on the display and press the **ENTER** button to select.
3. Press the  or  button to decrease or increase the temperature. Minimum bars = warmer, Maximum bars = cooler.
 - Set the temperature scale to a relative point where you feel comfortable.
 - The fan will now adjust itself up and down according to the relative comfort level automatically.
 - As the room temperature nears the selected comfort level, the water pump will turn off with the fan still running. The fan will only stop if the room temperature is more than 1 degree below the required comfort level.
4. To turn the unit OFF, press the **ON/OFF** button.

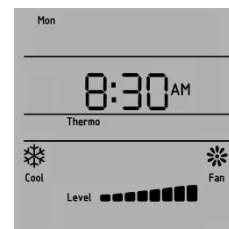

Ducted Evaporative Air Conditioning

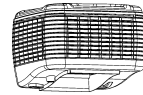

BOOST MODE



In the Boost mode the cooler runs both the pump and fan at maximum output level. To use the Boost mode -

- Press the **MODE** button until the Boost icon appears on the display and press the **ENTER** button to select. All of the 8 bars are displayed indicating full fan speed.
- Press the **MODE** button again to change to a different mode.



FAN MODE

The Navigator Controller provides 8 levels of Fan Only operation. The cooler runs the fan only with the output level set directly by the user (The unit will not cool in the Fan mode). To use the Fan mode -

- Turn the Navigator Controller ON by pressing the **ON/OFF** button.
- Press the **MODE** button until the Fan icon appears on the display and press the **ENTER** button to select.
- Press the  or  button to decrease or increase the fan speed. You can set the fan speed up to 8 levels.



PINNACLE ADDITIONAL FEATURES

- **Humidity Control**

Press & hold the **MODE** button when unit is running and display will show "Hd ty Ct rl".

- **EC motor**

When the fan motor comes on, there is a 5min delay to protect the motor from frequent power ups.

- **Salinity**

Salinity control is on by default factory settings.

- **Ioniser**

The Ioniser will be on all the time that the fan is running.

- **Pad Clean Function**

1. Turn the Navigator Controller ON by pressing the **ON/OFF** button.
2. Press the  button to decrease the fan speed to zero. The controls will display "Pu nP on ly".
3. Press the **MODE** button and it will display "Pad Cln". The unit will then go through its 20 minutes pad clean cycle.

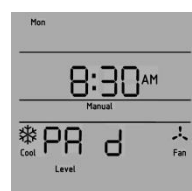
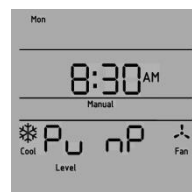
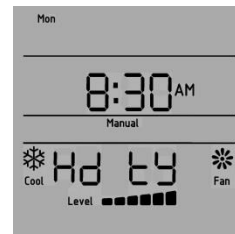

Ducted Evaporative Air Conditioning

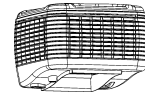

- **Exhaust**

This function is not enabled as default.

If this function is enabled then, press & hold the **MODE** button when the unit is in off state. The motor will run in reverse at 50% speed and the controls will display “EF An” on the screen.



- **Service Due**







This function is not enabled as default.

If this function is enabled then, the spanner icon  will display on the controls screen to indicate that a service is due.



26. TIMED OPERATION

Your Navigator Controller enables the START/STOP time to be set for Evaporative Coolers. If your Navigator Controller is ON, then you can set the OFF time and if your navigator Controller is OFF, then you can set the ON time for the Evaporative Cooler. The timed operation is cancelled by pressing the ON/OFF button. To set up the timed operation -

1. Press the **SETUP** button. The Clock, Program & Advanced (OFF state only) icons will display on the screen. The Clock is flashing.
2. Press the  or  button to select Program and then press the **ENTER** button.
3. The HOUR icon will flash. Press the  or  button to set the START/STOP hours and press the **ENTER** button to set.
4. The MINUTE icon will flash. Press the  or  button to set the START/STOP minutes and press the **ENTER** button to set.
5. Press the **SETUP** button to go to the main display at any time.

Now your program has been set. The Navigator Controller will turn ON/OFF your Cooler according to the program.

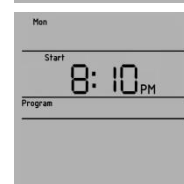
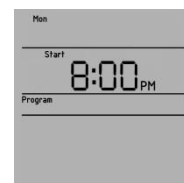
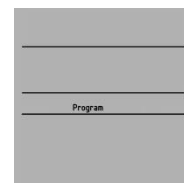
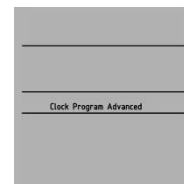

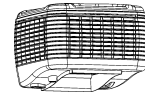

27. DUCTED EVAPORATIVE AIR CONDITIONER MAINTENANCE

GENERAL

All BONAIRE Ducted Evaporative Air Conditioners benefit from some general maintenance to ensure continued cooling efficiency and a long life. Maintenance is carried out at the beginning and end of summer to start up and close down your unit.

We recommend that all maintenance work be undertaken by our fully trained and accredited Service Technicians or an authorised Climate Technologies Service Provider.

The frequency of general maintenance will depend on local operating conditions such as water quality, air borne dust and pollen.

It is essential that your evaporative air conditioner is maintained in accordance with this manual. Failure to do so will affect the life of the product, reduce the level of efficiency and may void warranty.

For service Australia wide, refer to the details on the service section of this manual.

NOTE: *The manufacturer and its agents reserve the right to refuse service unless safety and accessibility to the unit can be guaranteed. The cost of any extra equipment required to provide access to the unit for servicing is the responsibility of the owner.*

SAFETY: *Prior to commencing any maintenance, isolate the unit from the power source. Ensure the roof is safe to access, your ladder is securely positioned and use suitable safety equipment.*

SERVICE ICON

If this function is enabled then after 700hrs of operation, the spanner icon  should display on the controls screen to indicate a service is due.

FILTER PADS

Visually check the CELDEK pads for damage or blockage. Hose down pads from both sides to remove any build up of salts, dust and pollen. In dusty areas, more regular cleaning is recommended. Check the water distributor, making sure it is clear and free from blockage. Failure to do so may lead to uneven water distribution and therefore less efficient operation.

WATER TANK

It is important to keep the water tank clean and free from sediment and algae growth. To clean the tank, use a soft brush or similar. Wipe all surfaces in the tank while it is full of water (DO NOT FORGET THE PUMP STRAINER). Allow to flush out through the Aquamiser valve (disconnecting and reconnecting power to the unit will open the Aquamiser valve).

SAFETY: *Wet roofs are dangerous – Take Care When Draining Tank.*

WATER LEVEL / FLOAT VALVE

The water level should be set at nominal 65-70mm from the top of the Aquamiser overflow before filter pads are saturated. After run off from operating filters the level from the top of the Aquamiser overflow should be 25 – 30mm. The float valve is a mechanical type and is factory set. If it requires adjustment, adjust the float ball, do not bend arm. If the valve is leaking the seal may require cleaning or replacing. Turn off the water. Remove the split pin and then float arm. Remove piston and clean or turn seal. Flush system and replace piston, float arm and split pin.

Ducted Evaporative Air Conditioning

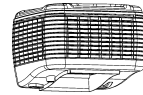

Note: *Water supply line to float valve must be flushed before connecting. Some discharge from the overflow may be experienced after shut down due to water draining back from the Celdek pads. This is normal.*

MOTOR AND FAN

Check that the fan spins freely and that there is no build up on the blades.

ELECTRICAL

No general maintenance is required to the electrical system.

Only a Qualified Electrician should carry out electrical connections and maintenance.

BLEED OFF

The bleed rate should be checked to ensure it is adequate and that there is no build up of mineral deposits in or on your air conditioner. White deposits indicate high mineral content and the Bleed Rate should be increased. If it is at maximum and the deposits are still forming, then more regular maintenance is required.

PUMP

Check the pump spins freely and that the strainer is clean.

WATER DISTRIBUTION

Check the water distribution system for blockage. Check the delivery tube for kinks or holes. Check that the clamps are secure and in place. Check that the flow rate is set correctly.

NO SEASONAL MAINTENANCE

Your unit has been supplied with an Aquamiser. As long as the Aquamiser has been fitted, there is no need for regular checking of the system during the operating (summer) period. This however does not remove the responsibility of the customer to have the unit serviced on an annual basis to check the unit function and to ensure the unit is clean and free from any mineral deposit build up.

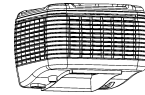
Ducted Evaporative Air Conditioning**28. PROBLEM SOLVING**

PROBLEM	PROBABLE CAUSE	REMEDY
Unit fails to start	a Black – out b Tripped Circuit Breaker c Blown Fuse d Electrical Fault	a Wait until power restored b Reset c Replace d Place a service call
Pump fails to start	a Pump Seized b Pump Burnt Out	a Place a service call b Place a service call
Water leaking from overflow	a Float Valve Leaking b Drain from Celdek Pads	a Check adjustment or replace seal b Normal Operation
Water droplets in air stream	a Loose Delivery Tube b Break in tubing c Pump delivers excessive water to pads	a Place a service call b Place a service call c Adjust DIALFLO valve see p29
Excessive humidity	a Inadequate Exhaust b Outside humidity high	a Provide more open area to exhaust stale air b Turn pump off.
Inadequate Cooling	a Dirty Filters b Dry Filters c Dialflo not set correctly	a Place a service call b Place a service call c Adjust DIALFLO valve see p29
Unpleasant Odor	a Unit located near odor source b New Celdek filter smell	a Remove source b Smell will disappear after a period of operation.
Rapid formation of white deposits on pads	High Mineral Content	Call Installer

THIS TROUBLE SHOOTING GUIDE IS A REFERENCE ONLY.

FOR SERVICE OR WARRANTY REQUIREMENTS PLEASE REFER

TO THE LAST PAGE OF THESE INSTRUCTIONS



Standard Warranty

IMPORTANT:

The warranties contained in this document (“**the warranty**”) are provided voluntarily by Climate Technologies (as manufacturer) to you (as consumer) in relation to your purchase of a product from Climate Technologies (“**the product**”) and are in addition to any rights you may have under the Australian Consumer Law or other applicable legislation. Please read this warranty in full and complete the Dealer / Product information on page 39. KEEP this with your original purchase documents for any claim you may wish to make under this warranty.

WARRANTY PROCEDURES:

Firstly refer to your owner’s manual to ensure that you have followed the correct operating procedures of your product, and refer to the trouble shooting guide to assist solving any problems you may have.

1. Read this warranty statement carefully before you request warranty service as items related to installation are not covered by this appliance warranty.
2. A proof of product purchase must be provided by you to Climate Technologies when exercising any rights under this or any statutory or other warranty, as evidence that the appliance is within the relevant manufacturer’s warranty periods (which are outlined in the tables on pages 41 and 42 of this warranty).
3. This warranty is only for Climate Technologies products and associated original controls for Climate Technologies manufactured product.
4. Only an authorised Climate Technologies service provider may carry out a warranty service.
5. To the extent permitted by law, any statutory warranty that applies to goods sold by Climate Technologies is valid for 12 months from the date of purchase and any additional warranties provided to you are at the sole discretion of Climate Technologies.

Climate Technologies provides the following Manufacturers warranty on new products in addition to all implied warranties and other statutory rights which you may have under the Australian Consumer Law and similar State & Territory Laws, subject to the following terms and conditions.

Terms and Conditions:

This warranty is subject to, and conditional upon, the following terms and conditions:

- Subject to the exclusions noted, Climate Technologies warrant the product for the period as prescribed in the table on pages 41 and 42 of this warranty to be free from inherent defects in materials and workmanship for functional and structural components.
- This warranty is only valid if the product is operated and maintained in accordance with the manufacturer’s instructions
- The appliance must not be modified or changed in any way.
- Your proof of purchase MUST be produced before free service will be provided.
- Travelling time and mileage are included in the service within 30km of either your authorised Climate Technologies dealer or service provider’s premises. Customers in areas other than the above are responsible for any travelling time and mileage required to carry out warranty repairs.
- The product purchased and subject to this warranty must be installed by a qualified person in the manner prescribed by local & statutory regulations and to the manufacturer’s specifications.

Standard Warranty effective May 1, 2012

Appliance Warranty – Australia Only (2012)



- Service within the terms of this warranty will be recognised where Climate Technologies are satisfied that the product or part was supplied within the relevant time limits (prescribed on pages 41 and 42 of this warranty). You are required to keep, and provide Climate Technologies with, proof of purchase and Dealer / Installer information in relation to the product the subject of your warranty claim.
- Product fitness for purpose and overall system design / sizing is solely the responsibility of the dealer / installer and, to the extent permitted by law, Climate Technologies takes no responsibility for, and this warranty is not valid to cover, any loss that is suffered by you as a result directly or indirectly of purchasing a product that is not fit for the purpose you intended or is in any other way inadequate for this purpose. This includes but is not limited to heat load calculations, air flow, system balancing, humidity, water quality etc.
- The product must be installed in an easily and safe accessible area for service. Where appliances are installed in areas not easily and safely accessible, costs will be borne by you for any access equipment required to be utilised by a representative or agent of Climate Technologies, in the event that maintenance of such an appliance is required.

DIY installation Warranty

If the product has been installed DIY or other than by an authorised person, a supply part only warranty will apply. Only parts will be supplied free of charge and then only on the return of the faulty part. In the event that a warranty claim is made to which this provision applies, you will be responsible for all labour charges incurred for the part to be fitted by a qualified person, such person to be appointed by Climate Technologies or one of their authorised dealers. The labour warranty as prescribed in the tables on pages 41 and 42 of this warranty are void where the product in question has not been installed by an authorised person.

Remote Location Warranty

If the product has been installed outside of the Climate Technologies service network, a supply part only warranty will apply. Only parts will be supplied free of charge where the product the subject of the warranty claim was installed further than 30km from the nearest Climate Technologies authorised dealer or service providers premises, and then only on the return of the faulty part. In the event that a warranty claim is made to which this provision applies, you will be responsible for all labour charges incurred for the part to be fitted by a qualified person, such a person to be appointed by Climate Technologies or one of their authorised dealers. The labour warranty prescribed in the tables on pages 41 and 42 of this warranty are void where the product in question has been installed in an area outside the Climate Technologies network (as prescribed above).

Effect of this Warranty

If you, as the purchaser of a product sold by Climate Technologies, comply with your obligations under this warranty document and a defect exists in a product you have purchased from Climate Technologies, Climate Technologies will, at its sole discretion, repair or replace the defective product (or part of it).

Any remedial work undertaken by Climate Technologies or one of its approved representatives or agents will be conducted at Climate Technologies sole expense, subject to the terms and conditions and exclusions contained in this warranty.

Climate Technologies will not reimburse you for any expense you have incurred in applying for a remedy under this warranty, including, but not limited to, any telephone calls or postage expenses incurred.



Exclusions to warranty

The following are not covered under this warranty, and Climate Technologies takes no responsibility for the replacement or repair of:

- Consumable items which are subject to wear and tear such as filter pads, drive belts, batteries and bearings;
- Any third party components used as part of the installation such as grille filters, ducting, fittings, zone motors and pipe work. These items are warranted from your place of purchase;
- Damage caused by elements such as wind, rain, lighting, floods etc along with power spiking and brownouts which are not considered by Climate Technologies in their sole discretion (acting reasonably) to be defective material or workmanship;
- Damage caused by outside elements such as pests, animals, pets and vermin or similar that may cause damage to the product;
- Harsh environmental situations such as salt air that may cause cabinet damage and/or rusting.

Please be aware that to the extent permitted by law, the manufacturer does not accept liability or any claims for damage to building contents, carpet, walls, ceilings, foundations or any other consequential loss incurred by you or any other person as a result of the purchase or installation of a product from Climate Technologies or by any other means, whether such loss was incurred directly or indirectly. For the avoidance of doubt, damage resulting from power spikes, incorrect operation, incorrect installation, and incorrect maintenance is also not covered under this warranty and such damage is not the responsibility of Climate Technologies.

All warranties contained in this warranty are given for the exclusive benefit of you as the purchaser of a Climate Technologies product and are not transferable and cannot be sold, assigned, gifted or transferred in any other way.

Events where warranty may be void

In the event that any of the following occur, this warranty may be void, and Climate Technologies reserves the right to refuse to repair or replace a defective product in accordance with a term of this warranty, where:

- There is no certificate of compliance for plumbing, electrical or refrigeration as required by State & Territory Laws;
- The product operates defectively due to failure of electricity, gas, water or refrigerant gas supplied;
- The defect is caused by neglect, incorrect application, abuse or by accidental damage to the product;
- An unauthorised person has attempted to repair the appliance;
- A situation arises which is referenced in the trouble-shooting guide (because you as the purchaser are required to remedy such a situation yourself).

Please note that a charge will be made for work done or a service call made where the Climate Technologies authorised representative or agent determines at his/her sole discretion (acting reasonably) that there is nothing wrong with the product in question.

Australian Consumer Law disclaimer

Our goods come with guarantees that cannot be excluded under the Australian Consumer Law. You are entitled to a replacement or refund for a major failure and for compensation for any other reasonably foreseeable loss or damage. You are also entitled to have the goods repaired or replaced if the goods fail to be of acceptable quality and the failure does not amount to a major failure.

Appliance Warranty – Australia Only (2012)**PROOF OF PURCHASE**

It is important that the name of the Dealer or Retailer from whom you purchased your product and the name of the installer are recorded on this page. The installer is responsible for the correct installation, start up and demonstrating the operation of this product. The Dealer or retailer is also responsible for issuing the relevant Certificates of Compliance (these may differ from state to state).

Please attach your proof of purchase here. Your receipt, along with the terms of this document is your warranty and will be required to validate any claim made under the terms of this warranty.

Dealer/Retailer:	
Dealer Address:	
Dealer Phone Number:	
Unit Model Number:	
Serial No:	
Date installed:	
Installed by:	
Date Commissioned:	
Commissioned by:	Signature:



HOW TO EXERCISE YOUR RIGHTS UNDER THIS WARRANTY

Only qualified service personnel should conduct any service work carried out on the Climate Technologies product. It is important that periodical service is carried out on your product to ensure you will receive the efficiency benefits the product provides.

If you acquire a product or service from Climate Technologies which is defective, please contact your nearest Climate Technologies representative on the phone numbers or emails listed below, or contact your nearest Climate Technologies Service Provider. Please note you will be required to show proof of your purchase, and comply with the terms and conditions and all other applicable provisions of this warranty in order for Climate Technologies to proceed with the remedial action prescribed under this warranty.

For Service, ring the telephone numbers below or send an email to the addresses below:

Fyshwick	ACT	(02) 6147 3490	nsw.service@climtech.com.au
Albury	NSW	(02) 6062 2990	nsw.service@climtech.com.au
Leeton	NSW	(02) 5924 1190	nsw.service@climtech.com.au
Silverwater	NSW	(02) 9735 7090	nsw.service@climtech.com.au
Wagga	NSW	(02) 5963 2939	nsw.service@climtech.com.au
Willawong	QLD	(07) 3712 4390	nsw.service@climtech.com.au
Salisbury	SA	(08) 8307 5230	service.sa@climtech.com.au
Bendigo	VIC	(03) 4411 1940	vic.service@climtech.com.au
Dandenong	VIC	(03) 8795 2456	vic.service@climtech.com.au
Shepparton	VIC	(03) 5835 6998	vic.service@climtech.com.au
Forrestfield	WA	(08) 9454 1000	service.wa@climtech.com.au

The business address of Climate Technologies is:

26 Nylex Avenue, Salisbury, SA, 5108

**PERIODS OF WARRANTY – Years By Product And Application:****Ducted Gas Heating – 3 star internal**

Unit Components	RESIDENTIAL		COMMERCIAL	
	Parts	Labour	Parts	Labour
Heat Exchanger	10	3	2	2
Burner	10	3	2	2
**All other components	3	3	1	1

** Excluding consumables and third party supplied components, which are not covered by this warranty.

Ducted Gas Heating – 3 star external, 4 star and 5 star

Unit Components	RESIDENTIAL		COMMERCIAL	
	Parts	Labour	Parts	Labour
Heat Exchanger	10	5	2	2
Burner	10	5	2	2
**All other components	5	5	1	1

** Excluding consumables and third party supplied components, which are not covered by this warranty.

Ducted Reverse Cycle Air Conditioning

Unit Components	RESIDENTIAL		COMMERCIAL	
	Parts	Labour	Parts	Labour
Compressor	5	5	2	2
**All other components	5	5	2	2

** Excluding consumables and third party supplied components, which are not covered by this warranty.

Dual Cycle Refrigerated Air Conditioning

Unit Components	RESIDENTIAL		COMMERCIAL	
	Parts	Labour	Parts	Labour
Compressor	5	5	2	2
** All other components	5	5	2	2

** Excluding consumables and third party supplied components, which are not covered by this warranty.

Ducted Evaporative Air Conditioning - Domestic

Unit Components	RESIDENTIAL		COMMERCIAL	
	Parts	Labour	Parts	Labour
Corrosion on Cabinet	25	5	2	2
Structural Guarantee	10	5	2	2
** All other components	5	5	1	1

** Excluding consumables and third party supplied components, which are not covered by this warranty.

Pinnacle Unit ONLY

Unit Components	RESIDENTIAL		COMMERCIAL	
	Parts	Labour	Parts	Labour
Corrosion on Cabinet	25	7	2	2
Structural Guarantee	10	7	2	2
** All other components	7	7	1	1

** Excluding consumables and third party supplied components, which are not covered by this warranty

**Ducted Evaporative Air Conditioning –Commercial Industrial**

Unit Components	Parts	Labour
Corrosion on Cabinet	2	2
Structural Guarantee	2	2
** All other components	2	2

** Excluding consumables and third party supplied components, which are not covered by this warranty.

Space Heater - Wall Furnace

Unit Components	RESIDENTIAL		COMMERCIAL	
	Parts	Labour	Parts	Labour
Heat Exchanger	10	2	2	2
Burner	10	2	2	2
All other components	2	2	1	1

Space Heater - Heritage

Unit Components	RESIDENTIAL		COMMERCIAL	
	Parts	Labour	Parts	Labour
Heat Exchanger & Burner	10	1	1	1
Blower (Fan)	2	2	1	1
All other components	1	1	1	1

Warranty on Replacement Parts

Parts replaced under warranty are warranted for the balance of the original warranty period.

Aged New Product Warranties

The terms of this Standard Warranty apply where the product is purchased and installed by the original purchaser within 3 years of the manufacturing date. To the extent permitted by law where, for whatever reason, a product is not installed within a period of 3 years of the manufacturing date of that product then the following warranty conditions will apply:

- For a product that is installed more than 3 years but less than 5 years from the date of its manufacture, the statutory warranties under the Australian Consumer Law or any other applicable legislation will apply and any voluntary warranty originally supplied by Climate Technologies under the terms of this warranty will be reduced by 1 year.
- To the extent permitted by law, for a product that is installed more than 5 years from the date of its manufacture, the statutory warranties under the Australian Consumer Law or any other applicable legislation will apply to electrically functioning components only. No other components will be covered by either this warranty or any warranty provided under the Australian Consumer Law or any other applicable legislation.
- For the avoidance of doubt, where a product is installed more than 5 years from the date of manufacture, no voluntary warranty originally supplied will be valid and Climate Technologies will not be responsible for the repair or replacement of the product, unless required to be pursuant to the Australian Consumer Law or similar applicable legislation.



“Excelling today for a better tomorrow”

Manufactured by
Climate Technologies
ABN 13 001 418 042

26 Nylex Avenue
Salisbury, SA 5108
Australia

www.climatetechnologies.com.au